



System/370

SR20-4460-2

Operator's Reference Guide

Major Revision (December 1976)

This is a major revision of and obsoletes the previous edition, SR20-4460-1.

Requests for copies of IBM publications should be made to your IBM representative or to the IBM branch office serving your locality. Address comments concerning the contents of this publication to IBM Corporation, DPD Education Development - Publishing/Media Support, Education Center, South Road, Poughkeepsie, New York 12602.

© Copyright International Business Machines Corporation 1976

Minor changes have been made in Section 3. The changes are indicated by a vertical line in the left margin.

Section 4 has been completely revised. The Operator Commands for the various operating systems have been updated to the current release: DOS/VS and POWER/VS to Release 33; OS/VS1 to Release 6; OS/VS2 SVS to Release 1.7; OS/VS2 MVS System, JES2, and JES3 commands to Release 3.7; and VM/370 commands to Release 3, PLC8.

Status and sense byte information for the IBM 3800 Printing subsystem and for the IBM 3850 Mass Storage System have been added in Section 5.

Two OS/VS Service Aids, SADMP and PRDMP, have been added to Section 6.

Changes are continually made to the information contained in this Guide. Before using this publication in connection with the operation of your IBM system, consult the IBM System/370 Bibliography to ascertain the current and applicable publications to your system.

PREFACE

This guide is designed as a handy, quick reference for System 370 operators of all levels and models. It includes a problem determination chart, S/370 general information, CPU manual procedures for Models 115 to 195, operator commands for the various operating systems, IPL procedures for DOS/VS and VS1 and VS2, I/O information (status and sense data, restart procedures, operating hints), utilities information, a glossary, bibliography, and index.

Since its purpose is to serve as a quick reference--a memory jogger to the operator in a dynamic, operating situation-- its content is slanted toward translation of code (bit information such as condition codes, status and sense bytes, etc.); command and record formats; operating procedures; and error restart procedures.

System 370 models embrace different kinds of hardware components and input/output units. The problem determination chart in the front of the guide is a generalized procedure for isolating trouble in the S/370. Once the malfunctioning unit has been isolated, flow charts for checking out that unit can be found in the relevant Operating Procedures SRL.

CPU manual procedures, by model, are provided in Section 3. The procedure for loading a secondary nucleus and the hard stop procedure are new in the guide. The rest of the procedures parallel those provided in the S/360 Operator's Reference Guide.

Depending on the operating system generated, S/370 operators use a variety of commands. OS/VS operators use VS1 and VS2 commands; DOS/VS operators use DOS/VS and POWER commands; VM/370 operators, CP and CMS commands; remote workstation operators, RES commands; and so on. In other words, each operator uses the commands suitable to his computer, operating system, and operator assignment. Section 4 contains the command formats for the various operating systems and operator consoles, and for remote as well as central CPU operators.

I/O status and sense byte information is summarized in Section 5. For the most part, only the first six bytes are shown, since these are all that concern the operator; the remaining bytes are of interest to the field engineer. Complete status and sense byte information usually appears in the Component Description SRL. For some of the smaller systems, however, status and sense information on I/O devices is presented in the Functional Characteristics SRL.

Of necessity, the information in this guide is highly condensed. Complete information is provided in the SRLs. To save the operator time we have noted the source of all information in this guide in order to steer him directly to the proper SRL. If the source appears just once, as at the beginning of Section 2, this means that all the information in that section comes from that single source. The titles of the source publications can be found in Bibliography 1, a numerically ordered list of all publications cited in this guide. Bibliography 2 lists publications not quoted from directly, is more comprehensive, and is arranged by subject matter.

Since this is an operator's guide, we have included only information which concerns the operator. For programming and field engineering information, consult the OS/VS Programmer's Reference Digest, the DOS/VS Handbook, and the FE Handbook.

Finally, a word of caution. For release-dependent information, check the appropriate SRL to determine whether the information contained in this guide has changed as a result of the new release. As of the date of publication, operator commands are current for OS/VS1 Release 3, OS/VS2 Release 2, VM/370 Release 2, and DOS/VS Release 29.

Table of Contents

Section 1: Problem Determination Chart	1-1
How To Call IBM for Service	1-11
Section 2: General Information	2-1
Machine Instructions	2-1
Floating-Point Instructions	2-3
Extended Mnemonic Instructions	2-3
Edit and Edmk Pattern Characters	2-3
Condition Codes	2-4
CNOF Alignment	2-4
Assembler Instructions	2-5
Summary of Constants	2-5
I/O Command Codes	2-6
Channels	2-6
Card Readers/Card Punches	2-6
Console Printers	2-6
Magnetic Tapes	2-6
Direct Access Storage Devices	2-7
Code Translation Table	2-8
ANSI-Defined Printer Control Characters	2-11
Machine Instruction Formats	2-12
Control Registers	2-12
Program Status Word (BC Mode)	2-13
Program Status Word (EC Mode)	2-13
Channel Command Word	2-13
Channel Status Word (hex 40)	2-13
Program Interruption Codes	2-13
Fixed Storage Locations	2-14
Limited Channel Logout (hex B0)	2-14
Machine Check Interruption Code (hex E8)	2-14
Dynamic Address Translation	2-15
Virtual (Logical) Address Format	2-15
Segment Table Entry	2-15
Page Table Entry	2-15
Hexadecimal and Decimal Conversion	2-15
Powers of 2 and 16	2-15
Section 3: CPU Manual Procedures	3-1
Functional Characteristics of Manual Controls	3-1
CPU Manual Procedures for:	
Mod 115	3-3
Mod 125	3-3
Mod 135	3-6
Mod 145	3-8
Mod 155	3-11
Mod 158	3-13
Mod 165	3-15
Mod 168	3-18
Mod 195	3-22

1

2

3

4

5

6

Section 4: Operator Commands	4-1
DOS/VS IPL Commands	4-1
DOS/VS Job Control and Attention Routine Commands	4-5
POWER/VS Commands	4-20
POWER/VS Central Operator Commands	4-21
POWER/VS JECL Statements	4-28
POWER/VS RJE Terminal Commands	4-33
VS1 System Commands	4-39
RES Workstation Commands	4-47
System Operator Commands for CRJE	4-50
OS/VS1 TCAM Commands	4-51
OS/VS VTAM Commands	4-57
VS1 Message Routing Codes	4-59
VS2 Message Routing Codes	4-59
Definitions of Substitutional Operands	4-60
OS/VS2 SVS Commands	4-62
OS/VS2 MVS System Commands	4-65
OS/VS2 JES2 Commands	4-81
OS/VS2 JES3 Commands	4-96
OS/VS2 TSO Commands	4-109
VM/370 Commands	4-127
CP Commands	4-128
CMS Commands	4-149
IPL Procedure for DOS/VS with the DOC	4-161
Display Operating Console - Model 115 and 125 - Commands	4-164
IPL Procedure for OS/VS1	4-167
IPL Procedure for OS/VS2 JES2	4-168
Formula for Computing Day of Year for Set Date Parameter	4-168
IPL Procedure for OS/VS2 JES3	4-169
OS/VS Display Consoles: Control Command and PFKs	4-171

Section 5: Input/Output Devices and Restart Procedures	5-1
Status Byte Summary	5-2
Sense Byte Summary	5-3
Card Readers: General Hints	5-11
2501 Card Reader	5-12
3504/3505 Stop Indications and Restart Procedures	5-14
3525 Stop Indications and Restart Procedures	5-20
OS/VS1 Checkpoint Restart	5-29
OS/VS2 Checkpoint Restart	5-30
3340 Disk Drive: Operating Hints	5-31
Console File S/370 Mod 125	5-33
Diskette	5-34
Operating Procedures	5-35
Cartridge Handling	5-36
3410/3411 Tape Drive	5-37
Operating Procedures after Failures	5-37
Cleaning Procedures	5-37
Tape Transport Cleaning	5-38
Tape Handling and Storage	5-39
3420 Tape Drive	5-40
Cleaning Procedures	5-40
Operating Procedures after Failures	5-40
Writing a Tape Mark	5-41

Section 1

General Information	1-1
Instructions for Submission of APARs to European Change Teams	1-2
Program ID Listings	1-6
OLT APAR Mailing List	1-33
APAR Mailing Addresses	1-34
FESER Mailing Addresses	1-41
PLM and Microfiche Numbers	1-42

Section 2

Programming System Memorandums

4 - APAR Procedures	2-1
General APAR Submission Procedures	2-1
100 Percent APAR Pre-Screening	2-1
APAR Appeal Process	2-3
Description of APAR Form Layout	2-5
APAR Documentation Requirements	2-13
APAR Requirements	2-15
Hints	2-15
Multi-System APAR Procedure	2-33
Request for Additional Information	2-34
APAR User Tape Procedures	2-34
Charges for Returned APAR Material	2-35
6 - How to Use EWS Programming Information	2-37
Programming Symptom Index (PSI)	2-37
APAR Numeric Index	2-40
PSI Text	2-41
Miscellaneous Program Support Information	2-41
15 - Publications Availability	2-43
16 - Standard Keyword Conventions for APAR	
Preparation	2-45
Introduction	2-45
Use of the Keyword Matrices	2-45
Conventions for APAR Abstract and Text	2-45
Retain/370 Internal Keyword Conventions	2-49
General Keyword Matrix	2-50
System Integrity (For 5752-MVS Only)	2-50
System Integrity PTFs	2-51
SU Standard Keywords	2-52
Keyword Matrix for System/3, System/32	2-53
Keyword Matrix for System/7	2-54
General Keyword Matrix	2-55
VM/370 Keyword Matrix	2-56
Matrix Keyword Dictionary	2-57
Reader's Comment Form	

OS/VS1 Service Aids	6-20
Executing SADMP	6-21
Executing PRDMP	6-22
OS/VS1 OLTEP	6-24
Section 7: Glossary	7-1
Section 8: Bibliography	8-1

Index

Section 1 Contents

Section 1: Problem Determination Chart	1-1
How To Call IBM for Service	1-11

Problem Determination

DEFINITION OF SYMBOLS USED IN FLOW CHARTS



Starting or terminating step.

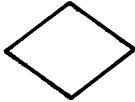

Question block which is asking for a "yes - no" or "on - off" answer. Output lines will be labeled.



Indicates some action is required or gives a brief description of situation.

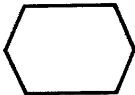

Refers reader to some other page for directions of particular operator action required.



Number within this symbol indicates one of the following:

1. Page number which references this page.
2. This page number, if this is a common entry from several other pages
3. Page to exit to in order to continue usage of charts

Problem Determination Chart S/370

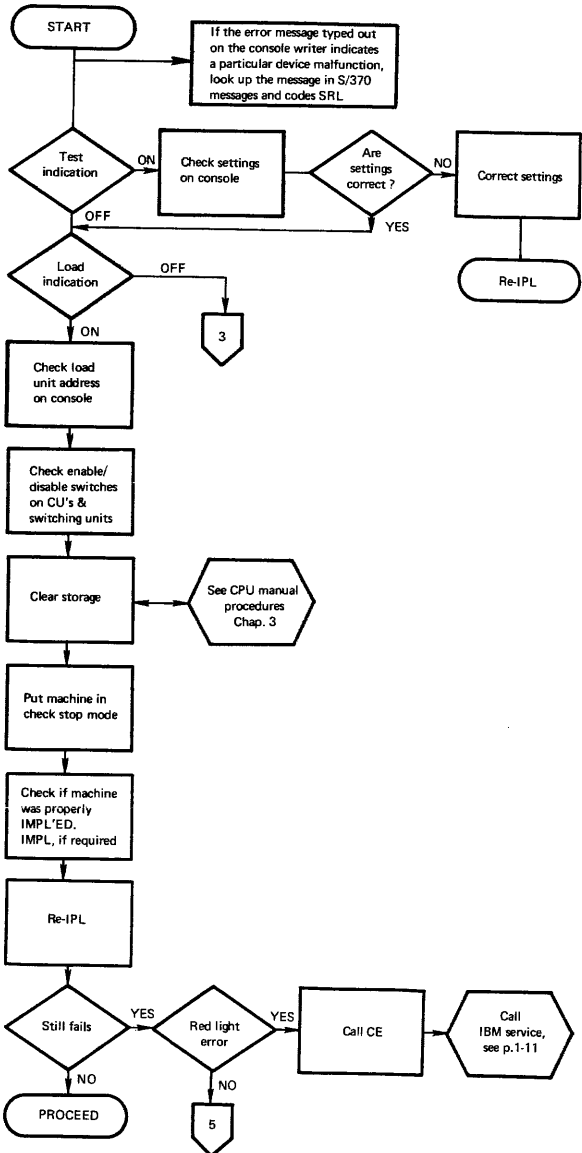

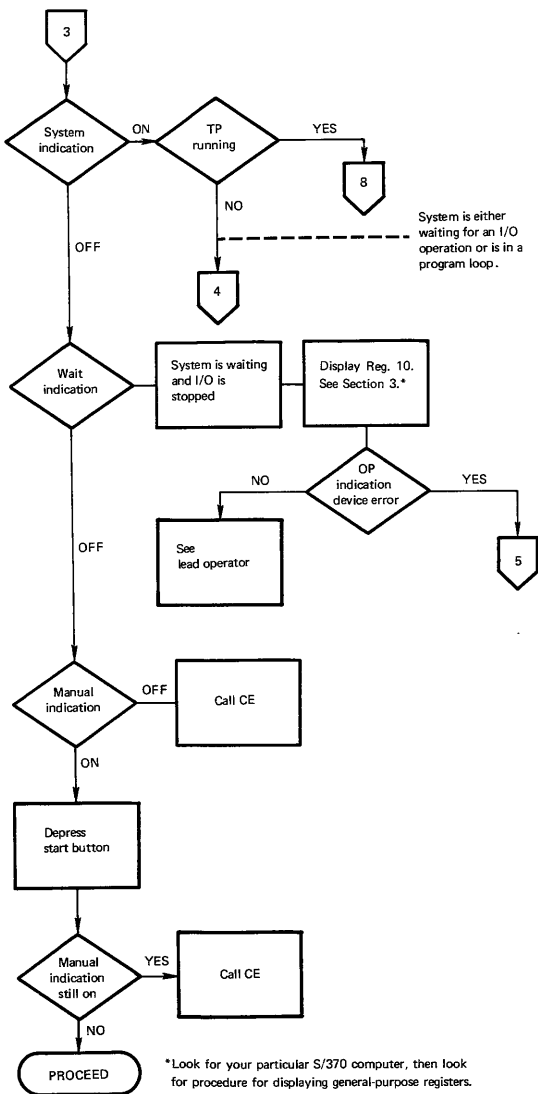

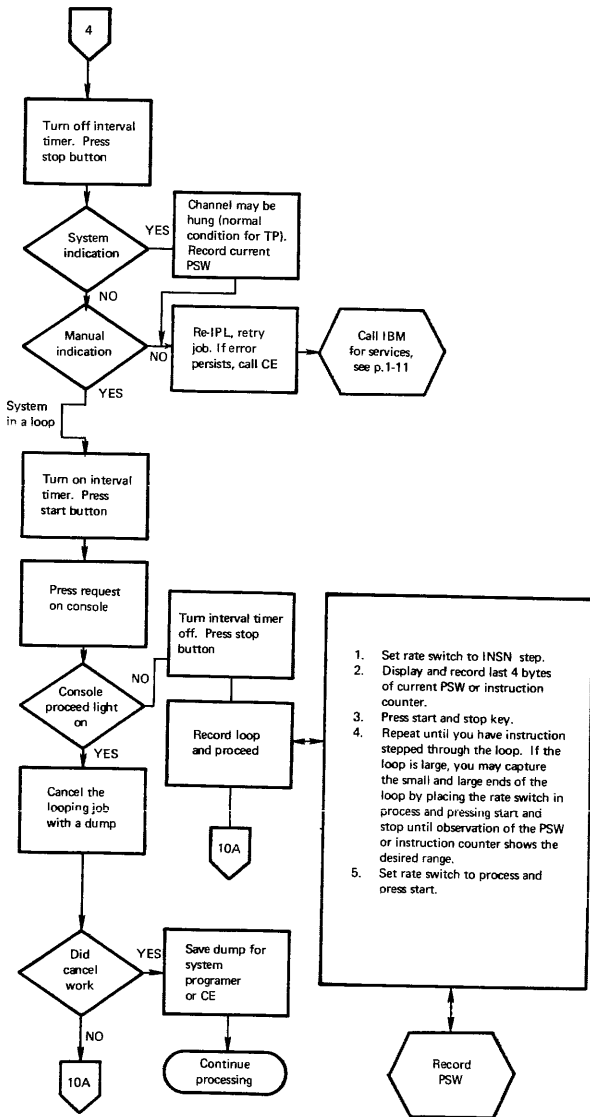

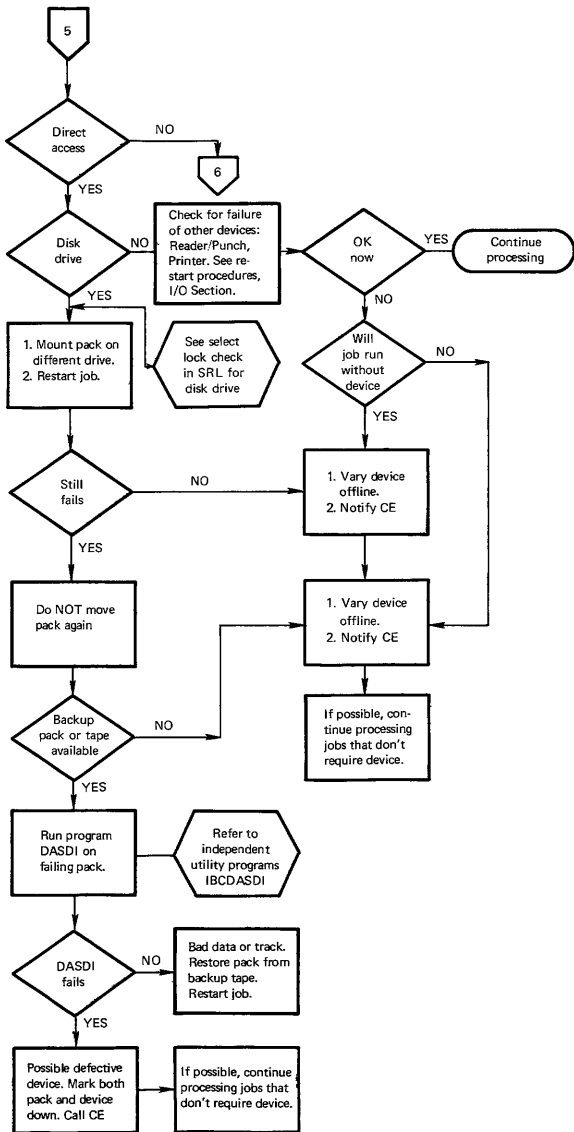

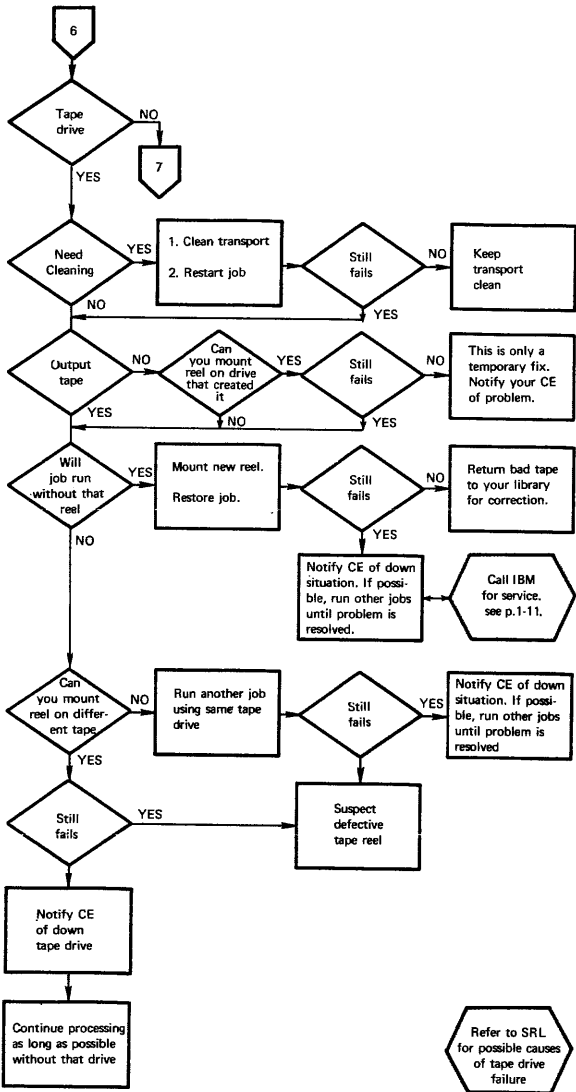

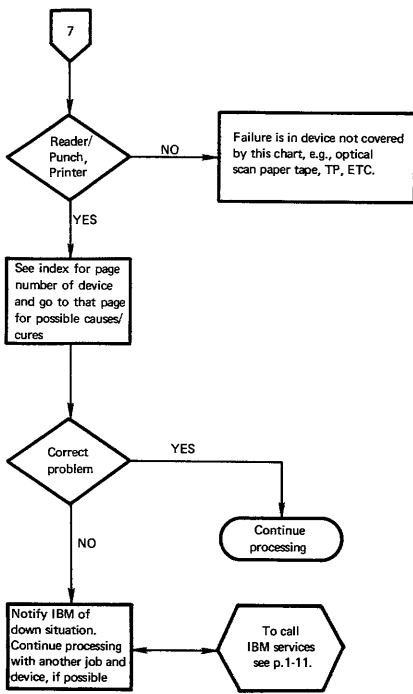

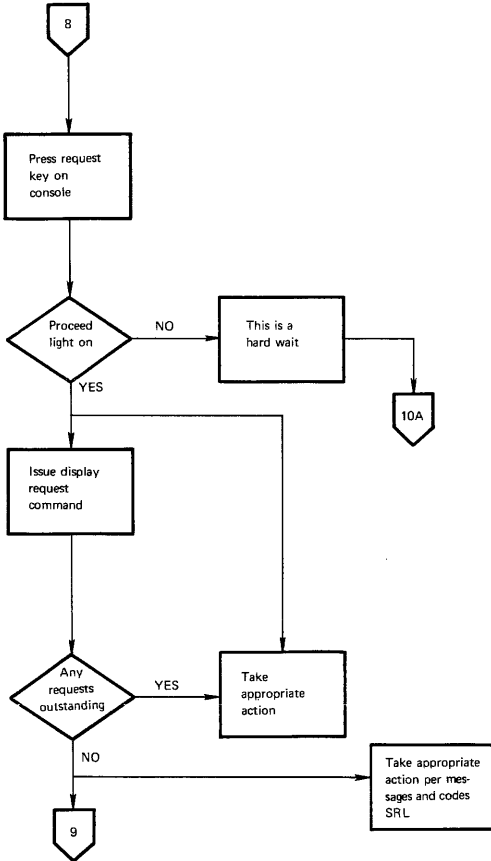

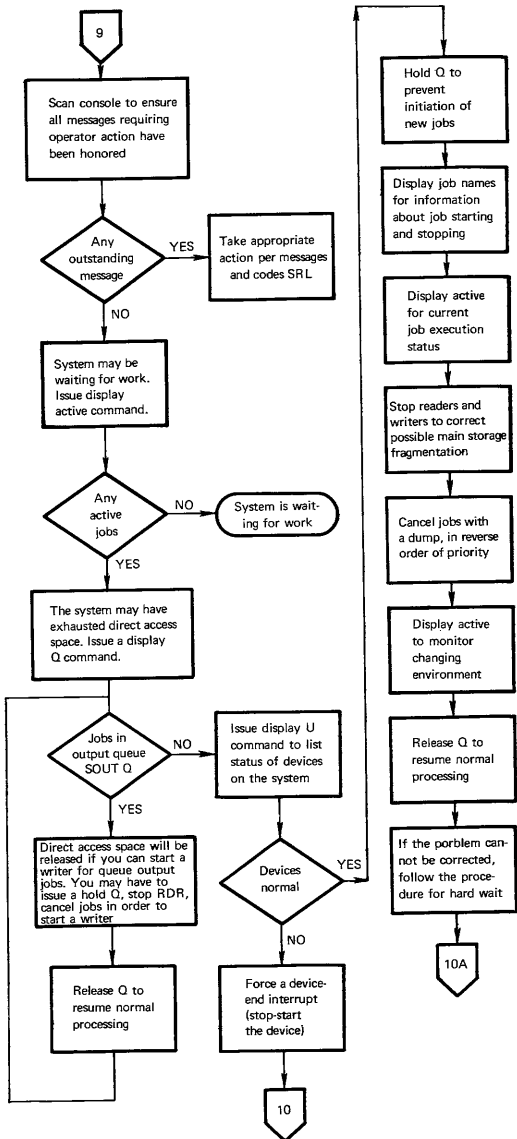

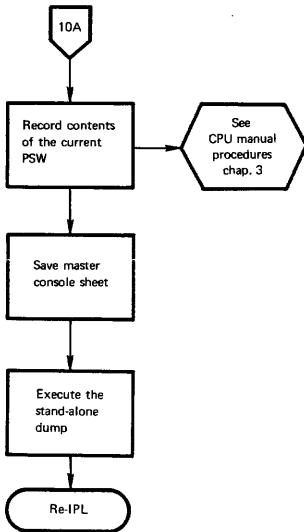
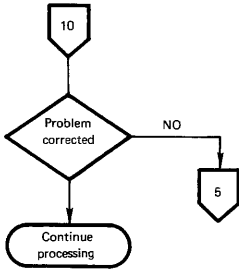

To Call IBM for Service

1. First check to see if there is a CE on site.
2. If not call your local IBM dispatch at:
Normal IBM Branch Office hours _____.
Outside of Normal Office hours _____.
3. Give dispatch the following information:
 1. Your company name, your name and extension.
 2. Type of machine (box) that gives the error indications.
 3. Type of system attached to (Mod 115, Mod 145, etc.)
 4. What is your urgency?
 5. If known, is your trouble hardware or software.
 6. Any special instructions a CE might need to know to get to your account.
 7. The CE that normally services your account.

CE NAME—_____.

Section 2 Contents

Section 2: General Information	2-1
Machine Instructions	2-1
Floating-Point Instructions	2-3
Extended Mnemonic Instructions	2-3
Edit and Edmk Pattern Characters	2-3
Condition Codes	2-4
CNOP Alignment	2-4
Assembler Instructions	2-5
Summary of Constants	2-5
I/O Command Codes	2-6
Channels	2-6
Card Readers/Card Punches	2-6
Console Printers	2-6
Magnetic Tapes	2-6
Direct Access Storage Devices	2-7
Code Translation Table	2-8
ANSI-Defined Printer Control Characters	2-11
Machine Instruction Formats	2-12
Control Registers	2-12
Program Status Word (BC Mode)	2-13
Program Status Word (EC Mode)	2-13
Channel Command Word	2-13
Channel Status Word (hex 40)	2-13
Program Interruption Codes	2-13
Fixed Storage Locations	2-14
Limited Channel Logout (hex B0)	2-14
Machine Check Interruption Code (hex E8)	2-14
Dynamic Address Translation	2-15
Virtual (Logical) Address Format	2-15
Segment Table Entry	2-15
Page Table Entry	2-15
Hexadecimal and Decimal Conversion	2-15
Powers of 2 and 16	2-15

System/370 General Information

Source: GX20-1850-2 System/370 Reference Summary

MACHINE INSTRUCTIONS

NAME	MNEMONIC	OP CODE	FOR-MAT	OPERANDS
Add (c)	AR	1A	RR	R1,R2
Add (c)	A	5A	RX	R1,D2(X2,B2)
Add Decimal (c)	AP	FA	SS	D1(L1,B1),D2(L2,B2)
Add Halfword (c)	AH	4A	RX	R1,D2(X2,B2)
Add Logical (c)	ALR	1E	RR	R1,R2
Add Logical (c)	AL	5E	RX	R1,D2(X2,B2)
AND (c)	NR	14	RR	R1,R2
AND (c)	N	54	RX	R1,D2(X2,B2)
AND (c)	NI	94	SI	D1(B1),I2
AND (c)	NC	D4	SS	D1(L,B1),D2(B2)
Branch and Link	BALR	05	RR	R1,R2
Branch and Link	BAL	45	RX	R1,D2(X2,B2)
Branch on Condition	BCR	07	RR	M1,R2
Branch on Condition	BC	47	RX	M1,D2(X2,B2)
Branch on Count	BCTR	06	RR	R1,R2
Branch on Count	BCT	46	RX	R1,D2(X2,B2)
Branch on Index High	BXH	86	RS	R1,R3,D2(B2)
Branch on Index Low or Equal	BXLE	87	RS	R1,R3,D2(B2)
Clear I/O (c,p)	CLRIO	9D01	S	D2(B2)
Compare (c)	CR	19	RR	R1,R2
Compare (c)	C	59	RX	R1,D2(X2,B2)
Compare and Swap (c)	CS	BA	RS	R1,R3,D2(B2)
Compare Decimal (c)	CP	F9	SS	D1(L1,B1),D2(L2,B2)
Compare Double and Swap (c)	CDS	BB	RS	R1,R3,D2(B2)
Compare Halfword (c)	CH	49	RX	R1,D2(X2,B2)
Compare Logical (c)	CLR	15	RR	R1,R2
Compare Logical (c)	CL	55	RX	R1,D2(X2,B2)
Compare Logical (c)	CLC	D5	SS	D1(L,B1),D2(B2)
Compare Logical (c)	CLI	95	SI	D1(B1),I2
Compare Logical Characters under Mask (c)	CLM	BD	RS	R1,M3,D2(B2)
Compare Logical Long (c)	CLCL	0F	RR	R1,R2
Convert to Binary	CVB	4F	RX	R1,D2(X2,B2)
Convert to Decimal	CVD	4E	RX	R1,D2(X2,B2)
Diagnose (p)		83		Model-dependent
Divide	DR	1D	RR	R1,R2
Divide	D	5D	RX	R1,D2(X2,B2)
Divide Decimal	DP	FD	SS	D1(L1,B1),D2(L2,B2)
Edit (c)	ED	DE	SS	D1(L,B1),D2(B2)
Edit and Mark (c)	EDMK	DF	SS	D1(L,B1),D2(B2)
Exclusive OR (c)	XR	17	RR	R1,R2
Exclusive OR (c)	X	57	RX	R1,D2(X2,B2)
Exclusive OR (c)	XI	97	SI	D1(B1),I2
Exclusive OR (c)	XC	D7	SS	D1(L,B1),D2(B2)
Execute	EX	44	RX	R1,D2(X2,B2)
Halt I/O (c,p)	HIO	9E00	S	D2(B2)
Halt Device (c,p)	HDV	9E01	S	D2(B2)
Insert Character	IC	43	RX	R1,D2(X2,B2)
Insert Characters under Mask (c)	ICM	BF	RS	R1,M3,D2(B2)
Insert PSW Key (p)	IPK	B20B	S	
Insert Storage Key (p)	ISK	09	RR	R1,R2
Load	LR	18	RR	R1,R2
Load	L	58	RX	R1,D2(X2,B2)
Load Address	LA	41	RX	R1,D2(X2,B2)
Load and Test (c)	LTR	12	RR	R1,R2
Load Complement (c)	LCR	13	RR	R1,R2
Load Control (p)	LCTL	B7	RS	R1,R3,D2(B2)
Load Halfword	LH	48	RX	R1,D2(X2,B2)
Load Multiple	LM	98	RS	R1,R3,D2(B2)
Load Negative (c)	LNR	11	RR	R1,R2
Load Positive (c)	LPR	10	RR	R1,R2
Load PSW (n,p)	LPSW	82	S	D2(B2)
Load Real Address (c,p)	LRA	B1	RX	R1,D2(X2,B2)
Monitor Call	MC	AF	SI	D1(B1),I2
Move	MVI	92	SI	D1(B1),I2
Move	MVC	D2	SS	D1(L,B1),D2(B2)
Move Long (c)	MVCL	0E	RR	R1,R2
Move Numerics	MVN	D1	SS	D1(L,B1),D2(B2)
Move with Offset	MVO	F1	SS	D1(L1,B1),D2(L2,B2)
Move Zones	MVZ	D3	SS	D1(L,B1),D2(B2)
Multiply	MR	1C	RR	R1,R2
Multiply	M	5C	RX	R1,D2(X2,B2)
Multiply Decimal	MP	FC	SS	D1(L1,B1),D2(L2,B2)
Multiply Halfword	MH	4C	RX	R1,D2(X2,B2)
OR (c)	OR	16	RR	R1,R2

MACHINE INSTRUCTIONS (Contd)

NAME	MNEMONIC	OP CODE	FOR- MAT	OPERANDS
OR (c)	O	56	RX	R1,D2(X2,B2)
OR (c)	OI	96	SI	D1(B1),I2
OR (c)	OC	D6	SS	D1(L,B1),D2(B2)
Pack	PACK	F2	SS	D1(L1,B1),D2(L2,B2)
Purge TLB (p)	PTLB	B20D	S	
Read Direct (p)	RDD	85	SI	D1(B1),I2
Reset Reference Bit (c,p)	RRB	B213	S	D2(B2)
Set Clock (c,p)	SCK	B204	S	D2(B2)
Set Clock Comparator (p)	SCKC	B206	S	D2(B2)
Set CPU Timer (p)	SPT	B208	S	D2(B2)
Set Prefix (p)	SPX	B210	S	D2(B2)
Set Program Mask (n)	SPM	04	RR	R1
Set PSW Key from Address (p)	SPKA	B20A	S	D2(B2)
Set Storage Key (p)	SSK	08	RR	R1,R2
Set System Mask (p)	SSM	90	S	D2(B2)
Shift and Round Decimal (c)	SRP	F0	SS	D1(L1,B1),D2(B2),I3
Shift Left Double (c)	SLDA	8F	RS	R1,D2(B2)
Shift Left Double Logical	SLDL	8D	RS	R1,D2(B2)
Shift Left Single (c)	SLA	8B	RS	R1,D2(B2)
Shift Left Single Logical	SLL	89	RS	R1,D2(B2)
Shift Right Double (c)	SRDA	8E	RS	R1,D2(B2)
Shift Right Double Logical	SRDL	8C	RS	R1,D2(B2)
Shift Right Single (c)	SRA	8A	RS	R1,D2(B2)
Shift Right Single Logical	SRL	88	RS	R1,D2(B2)
Signal Processor (c,p)	SIGP	AE	RS	R1,R3,D2(B2)
Start I/O (c,p)	SIO	9C00	S	D2(B2)
Start I/O Fast Release (c,p)	SIOF	9C01	S	D2(B2)
Store	ST	50	RX	R1,D2(X2,B2)
Store Channel ID (c,p)	STIDC	B203	S	D2(B2)
Store Character	STC	42	RX	R1,D2(X2,B2)
Store Characters under Mask	STCM	8E	RS	R1,M3,D2(B2)
Store Clock (c)	STCK	B205	S	D2(B2)
Store Clock Comparator (p)	STCKC	B207	S	D2(B2)
Store Control (p)	STCTL	86	RS	R1,R3,D2(B2)
Store CPU Address (p)	STAP	B212	S	D2(B2)
Store CPU ID (p)	STIDP	B202	S	D2(B2)
Store CPU Timer (p)	STPT	B209	S	D2(B2)
Store Halfword	STH	40	RX	R1,D2(X2,B2)
Store Multiple	STM	90	RS	R1,R3,D2(B2)
Store Prefix (p)	STPX	B211	S	D2(B2)
Store Then AND System Mask (p)	STNSM	AC	SI	D1(B1),I2
Store Then OR System Mask (p)	STOSM	AD	SI	D1(B1),I2
Subtract (c)	SR	18	RR	R1,R2
Subtract (c)	S	58	RX	R1,D2(X2,B2)
Subtract Decimal (c)	SP	F8	SS	D1(L1,B1),D2(L2,B2)
Subtract Halfword (c)	SH	48	RX	R1,D2(X2,B2)
Subtract Logical (c)	SLR	1F	RR	R1,R2
Subtract Logical (c)	SL	5F	RX	R1,D2(X2,B2)
Supervisor Call	SVC	0A	RR	I
Test and Set (c)	TS	93	S	D2(B2)
Test Channel (c,p)	TCH	9F00	S	D2(B2)
Test I/O (c,p)	TIO	9D00	S	D2(B2)
Test under Mask (c)	TM	91	SI	D1(B1),I2
Translate	TR	DC	SS	D1(L,B1),D2(B2)
Translate and Test (c)	TRT	DD	SS	D1(L,B1),D2(B2)
Unpack	UNPK	F3	SS	D1(L1,B1),D2(L2,B2)
Write Direct (p)	WRD	84	SI	D1(B1),I2
Zero and Add Decimal (c)	ZAP	F8	SS	D1(L1,B1),D2(L2,B2)

Floating-Point Instructions

NAME	MNEMONIC	OP CODE	FOR- MAT	OPERANDS
Add Normalized, Extended (c,x)	AXR	36	RR	R1,R2
Add Normalized, Long (c)	ADR	2A	RR	R1,R2
Add Normalized, Long (c)	AD	6A	RX	R1,D2(X2,B2)
Add Normalized, Short (c)	AER	3A	RR	R1,R2
Add Normalized, Short (c)	AE	7A	RX	R1,D2(X2,B2)
Add Unnormalized, Long (c)	AWR	2E	RR	R1,R2
Add Unnormalized, Long (c)	AW	6E	RX	R1,D2(X2,B2)
Add Unnormalized, Short (c)	AUR	3E	RR	R1,R2
Add Unnormalized, Short (c)	AU	7E	RX	R1,D2(X2,B2)

c. Condition code is set.

p. Privileged instruction.

n. New condition code is loaded.

x. Extended precision floating-point.

Floating-Point Instructions (Contd)

NAME	MNEMONIC	OP CODE	FOR-MAT	OPERANDS
Compare, Long (c)	CDR	29	RR	R1,R2
Compare, Long (c)	CD	69	RX	R1,D2(X2,B2)
Compare, Short (c)	CER	39	RR	R1,R2
Compare, Short (c)	CE	79	RX	R1,D2(X2,B2)
Divide, Long	DDR	2D	RR	R1,R2
Divide, Long	DD	6D	RX	R1,D2(X2,B2)
Divide, Short	DER	3D	RR	R1,R2
Divide, Short	DE	7D	RX	R1,D2(X2,B2)
Halve, Long	HDR	24	RR	R1,R2
Halve, Short	HER	34	RR	R1,R2
Load and Test, Long (c)	LTDR	22	RR	R1,R2
Load and Test, Short (c)	LTER	32	RR	R1,R2
Load Complement, Long (c)	LCDR	23	RR	R1,R2
Load Complement, Short (c)	LCER	33	RR	R1,R2
Load, Long	LDR	28	RR	R1,R2
Load, Long	LD	68	RX	R1,D2(X2,B2)
Load Negative, Long (c)	LNDR	21	RR	R1,R2
Load Negative, Short (c)	LNER	31	RR	R1,R2
Load Positive, Long (c)	LPDR	20	RR	R1,R2
Load Positive, Short (c)	LPER	30	RR	R1,R2
Load Rounded, Extended to Long (x)	LRDR	25	RR	R1,R2
Load Rounded, Long to Short (x)	LRER	35	RR	R1,R2
Load, Short	LER	38	RR	R1,R2
Load, Short	LE	78	RX	R1,D2(X2,B2)
Multiply, Extended (x)	MXR	26	RR	R1,R2
Multiply, Long	MDR	2C	RR	R1,R2
Multiply, Long	MD	6C	RX	R1,D2(X2,B2)
Multiply, Long/Extended (x)	MXDR	27	RR	R1,R2
Multiply, Long/Extended (x)	MXD	67	RX	R1,D2(X2,B2)
Multiply, Short	MER	3C	RR	R1,R2
Multiply, Short	ME	7C	RX	R1,D2(X2,B2)
Store, Long	STD	60	RX	R1,D2(X2,B2)
Store, Short	STE	70	RX	R1,D2(X2,B2)
Subtract Normalized, Extended (c,x)	SXR	37	RR	R1,R2
Subtract Normalized, Long (c)	SDR	2B	RR	R1,R2
Subtract Normalized, Long (c)	SD	6B	RX	R1,D2(X2,B2)
Subtract Normalized, Short (c)	SER	3B	RR	R1,R2
Subtract Normalized, Short (c)	SE	7B	RX	R1,D2(X2,B2)
Subtract Unnormalized, Long (c)	SWR	2F	RR	R1,R2
Subtract Unnormalized, Long (c)	SW	6F	RX	R1,D2(X2,B2)
Subtract Unnormalized, Short (c)	SUR	3F	RR	R1,R2
Subtract Unnormalized, Short (c)	SU	7F	RX	R1,D2(X2,B2)

EXTENDED MNEMONIC INSTRUCTIONS†

Use	Extended Code* (RX or RR)	Meaning	Machine Instr.* (RX or RR)
General	B or BR	Unconditional Branch	BC or BCR 15,
	NOP or NOPR	No Operation	BC or BCR 0,
After	BH or BHR	Branch on A High	BC or BCR 2,
Compare	BL or BLR	Branch on A Low	BC or BCR 4,
Instructions (A:B)	BE or BER	Branch on A Equal B	BC or BCR 8,
	BNH or BNHR	Branch on A Not High	BC or BCR 13,
	BNL or BNLR	Branch on A Not Low	BC or BCR 11,
	BNE or BNER	Branch on A Not Equal B	BC or BCR 7,
After	BO or BOR	Branch on Overflow	BC or BCR 1,
Arithmetic Instructions	BP or BPR	Branch on Plus	BC or BCR 2,
	BM or BMR	Branch on Minus	BC or BCR 4,
	BNP or BNPR	Branch on Not Plus	BC or BCR 13,
	BNM or BNMR	Branch on Not Minus	BC or BCR 11,
	BNZ or BNZR	Branch on Not Zero	BC or BCR 7,
	BZ or BZR	Branch on Zero	BC or BCR 8,
	After Test under Mask Instruction	BO or BOR	Branch if Ones
	BM or BMR	Branch if Mixed	BC or BCR 4,
	BZ or BZR	Branch if Zeros	BC or BCR 8,
	BNO or BNOR	Branch if Not Ones	BC or BCR 14,

*Second operand not shown; in all cases it is D2(X2,B2) for RX format or R2 for RR format.

† For OS/V5 and DOS/V5; source: GC33-4010.

EDIT AND EDMK PATTERN CHARACTERS (in hex)

20—digit selector	40—blank	5C—asterisk
21—start of significance	4B—period	6B—comma
22—field separator	5B—dollar sign	C3D9—CR

CONDITION CODES

Condition Code Setting Mask Bit Value	0	1	2	3
	8	4	2	1
General Instructions				
Add, Add Halfword	zero	<zero	>zero	overflow
Add Logical	zero, no carry	not zero, no carry	zero, carry	not zero, carry
AND	zero	not zero	—	—
Compare, Compare Halfword	equal	1st op low	1st op high	—
Compare and Swap/Double	equal	not equal	—	—
Compare Logical	equal	1st op low	1st op high	—
Exclusive OR	zero	not zero	—	—
Insert Characters under Mask	all zero	1st bit one	1st bit zero	—
Load and Test	zero	<zero	>zero	—
Load Complement	zero	<zero	>zero	overflow
Load Negative	zero	<zero	—	—
Load Positive	zero	—	>zero	overflow
Move Long	count equal	count low	count high	overlap
OR	zero	not zero	—	—
Shift Left Double/Single	zero	<zero	>zero	overflow
Shift Right Double/Single	zero	<zero	>zero	—
Store Clock	set	not set	error	not oper
Subtract, Subtract Halfword	zero	<zero	>zero	overflow
Subtract Logical	—	not zero, no carry	zero, carry	not zero, carry
Test and Set	zero	one	—	—
Test under Mask	zero	mixed	—	ones
Translate and Test	zero	incomplete	complete	—
Decimal Instructions				
Add Decimal	zero	<zero	>zero	overflow
Compare Decimal	equal	1st op low	1st op high	—
Edit, Edit and Mark	zero	<zero	>zero	—
Shift and Round Decimal	zero	<zero	>zero	overflow
Subtract Decimal	zero	<zero	>zero	overflow
Zero and Add	zero	<zero	>zero	overflow
Floating-Point Instructions				
Add Normalized	zero	<zero	>zero	—
Add Unnormalized	zero	<zero	>zero	—
Compare	equal	1st op low	1st op high	—
Load and Test	zero	<zero	>zero	—
Load Complement	zero	<zero	>zero	—
Load Negative	zero	<zero	—	—
Load Positive	zero	—	>zero	—
Subtract Normalized	zero	<zero	>zero	—
Subtract Unnormalized	zero	<zero	>zero	—
Input/Output Instructions				
Clear I/O	no oper in progress	CSW stored	chan busy	not oper
Halt Device	interruption pending	CSW stored	channel working	not oper
Halt I/O	interruption pending	CSW stored	burst op stopped	not oper
Start I/O, SIOF	successful	CSW stored	busy	not oper
Store Channel ID	ID stored	CSW stored	busy	not oper
Test Channel	available	interruption pending	burst mode	not oper
Test I/O	available	CSW stored	busy	not oper
System Control Instructions				
Load Real Address	translation available	ST entry invalid	PT entry invalid	length violation
Reset Reference Bit	R=0, C=0	R=0, C=1	R=1, C=0	R=1, C=1
Set Clock	set	secure	—	not oper
Signal Processor	accepted	stat stored	busy	not oper

CNOP ALIGNMENT

DOUBLEWORD							
WORD				WORD			
HALFWORD		HALFWORD		HALFWORD		HALFWORD	
BYTE	BYTE	BYTE	BYTE	BYTE	BYTE	BYTE	BYTE
↙	↖	↙	↖	↙	↖	↙	↖
0,4	2,4	0,4	2,4	0,4	2,4	0,4	2,4
0,8	2,8	4,8	6,8				

ASSEMBLER INSTRUCTIONS†

Function	Mnemonic	Meaning
Data definition	DC	Define constant
	DS	Define storage
	CCW	Define channel command word
Program sectioning and linking	START	Start assembly
	CSECT	Identify control section
	DSECT	Identify dummy section
	DXD*	Define external dummy section
	CXD*	Cumulative length of external dummy section
	COM	Identify blank common control section
	ENTRY	Identify entry-point symbol
Base register assignment	EXTRN	Identify external symbol
	WXTRN	Identify weak external symbol
	USING	Use base address register
Control of listings	DROP	Drop base address register
	TITLE	Identify assembly output
	EJECT	Start new page
	SPACE	Space listing
Program Control	PRINT	Print optional data
	ICTL	Input format control
	ISEQ	Input sequence checking
	PUNCH	Punch a card
	REPRO	Reproduce following card
	ORG	Set location counter
	EQU	Equate symbol
	OPSYN*	Equate operation code
	PUSH*	Save current PRINT or USING status
	POP*	Restore PRINT or USING status
	LTORG	Begin literal pool
	CNOP	Conditional no operation
	COPY	Copy predefined source coding
	END	End assembly
	Macro definition	MACRO
MNOTE		Request for error message
MEXIT		Macro definition exit
MEND		Macro definition trailer
Conditional assembly	ACTR	Conditional assembly loop counter
	AGO	Unconditional branch
	AIF	Conditional branch
	ANOP	Assembly no operation
	GBLA	Define global SETA symbol
	GBLB	Define global SETB symbol
	GBLC	Define global SETC symbol
	LCLA	Define local SETA symbol
	LCLB	Define local SETB symbol
	LCLC	Define local SETC symbol
	SETA	Set arithmetic variable symbol
	SETB	Set binary variable symbol
	SETC	Set character variable symbol

SUMMARY OF CONSTANTST

TYPE	IMPLIED LENGTH, BYTES	ALIGNMENT	FORMAT	TRUNCATION/PADDING
C	-	byte	characters	right
X	-	byte	hexadecimal digits	left
B	-	byte	binary digits	left
F	4	word	fixed-point binary	left
H	2	halfword	fixed-point binary	left
E	4	word	short floating-point	right
D	8	doubleword	long floating-point	right
L	16	doubleword	extended floating-point	right
P	-	byte	packed decimal	left
Z	-	byte	zoned decimal	left
A	4	word	value of address	left
Y	2	halfword	value of address	left
S	2	halfword	address in base-displacement form	-
V	4	word	externally defined address value	left
Q*	4	word	symbol naming a DXD or DSECT	left

† For OS/VS and DOS/VS; source: GC33-4010.

* OS/VS only.

I/O COMMAND CODES

Standard Command Code Assignments (CCW bits 0-7)

xxxx 0000	Invalid	†††† ††01	Write
†††† 0100	Sense	†††† ††10	Read
xxxx 1000	Transfer in Channel	†††† ††11	Control
†††† 1100	Read Backward	0000 0011	Control No Operation

x—Bit ignored.

†Modifier bit for specific type of I/O device

CONSOLE PRINTERS

Write, No Carrier Return	01	Sense	04
Write, Auto Carrier Return	09	Audible Alarm	0B
Read Inquiry	0A		

3504, 3505 CARD READERS/3525 CARD PUNCH

Source: GA21-9124

Command	Binary	Hex	Bit Meanings
Sense	0000 0100	04	<u>SS</u> <u>Stacker</u>
Feed, Select Stacker	SS10 F011		00 1
Read Only*	11D0 F010		01/10 2
Diagnostic Read	1101 0010	D2	<u>F</u> <u>Format Mode</u>
Read, Feed, Select Stacker*	SSD0 F010		0 Unformatted
Write RCE Format*	0001 0001	11	1 Formatted
<u>3504, 3505 only</u>			<u>D</u> <u>Data Mode</u>
Write OMR Format†	0011 0001	31	0 1—EBCDIC
			1 2—Card image
<u>3525 only</u>			<u>L</u> <u>Line Position</u>
Write, Feed, Select Stacker	SSD0 0001		5-bit binary value
Print Line*	LLLL L101		

*Special feature on 3525.

†Special feature.

PRINTERS: 3211/3811 (GA24-3543), 3203/1PA, 1403*/2821 (GA24-3312)

	After Write	Immed	Write without spacing	
Space 1 Line	09	0B	Sense	04
Space 2 Lines	11	13	Load UCSB without folding	FB
Space 3 Lines	19	1B	Fold†	43
Skip to Channel 0†	—	83	Unfold†	23
Skip to Channel 1	89	8B	Load UCSB and Fold (exc. 3211)	F3
Skip to Channel 2	91	93	UCS Gate Load (1403 only)	EB
Skip to Channel 3	99	9B	Load FCB†	63
Skip to Channel 4	A1	A3	Block Data Check	73
Skip to Channel 5	A9	AB	Allow Data Check	7B
Skip to Channel 6	B1	B3	Read PLB†	02
Skip to Channel 7	B9	BB	Read UCSB†	0A
Skip to Channel 8	C1	C3	Read FCB†	12
Skip to Channel 9	C9	CB	Diag. Check Read (exc. 3203)	06
Skip to Channel 10	D1	D3	Diagnostic Write†	05
Skip to Channel 11	D9	DB	Raise Cover†	6B
Skip to Channel 12	E1	E3	Diagnostic Gate†	07
			Diagnostic Read (1403 only)	02

*UCS special feature; 1PA diagnostics are model-dependent.

†3211 only.

3420/3803, 3410/3411 MAGNETIC TAPE

(**Indicates 3420 only)

See GA32-0020, -0021, -0022 for special features and functions of specific models.

		Density	Parity	DC	Trans	Cmd
Write	01					
Read Forward	02					
Read Backward	0C					
Sense	04	200	odd	on	off	13
Sense Reserve**	F4			off	off	33
Sense Release**	D4		even	on	on	38
Request Track-in-Error	1B		off	off	23	
Loop Write-to-Read**	8B	556	odd	on	off	53
Set Diagnose**	4B			off	off	73
Rewind	07		even	on	on	7B
Rewind Unload	0F		off	off	63	
Erase Gap	17	800	odd	on	off	93
Write Tape Mark	1F			off	off	B3
Backspace Block	27		even	on	on	BB
Backspace File	2F		off	off	A3	
Forward Space Block	37			on	AB	
Forward Space File	3F	Mode Set 2 (9-track), 800 bpi				CB
Data Security Erase**	97	Mode Set 2 (9-track), 1600 bpi				C3
Diagnostic Mode Set**	0B	Mode Set 2 (9-track), 6250 bpi**				D3

I/O COMMAND CODES (Contd)

DIRECT ACCESS STORAGE DEVICES:

3330-3340 SERIES (GA26-1592, -1617, -1620);

2305/2835 (GA26-1589); 2314, 2319 (GA26-3599, -1606)

Command		MT Off	MT On*	Count	
Control	Orient (c)	2B		Nonzero	
	Recalibrate	13		Nonzero	
	Seek	07		6	
	Seek Cylinder	08		6	
	Seek Head	18		6	
	Space Count	0F		3 (a); nonzero (d)	
	Set File Mask	1F		1	
	Set Sector (a,f)	23		1	
	Restore (executes as a no-op)	17		Nonzero	
	Vary Sensing (c)	27		1	
	Diagnostic Load (a)	53		1	
	Diagnostic Write (a)	73		512	
	Search	Home Address Equal	39	B9	4
		Identifier Equal	31	B1	5
Identifier High		51	D1	5	
Identifier Equal or High		71	F1	5	
Key Equal		29	A9	KL	
Key High		49	C9	KL	
Key Equal or High		69	E9	KL	
Key and Data Equal (d)		2D	AD	} Number of bytes (including mask bytes) in search argument	
Key and Data High (d)		4D	CD		
Key and Data Eq. or Hi (d)		6D	ED		
Continue Search Equal (d)	25	A5			
Scan	Search High (d)	45	C5	} Number of bytes to be transferred	
	Search High or Equal (d)	65	E5		
	Set Compare (d)	35	B5		
Read	Set Compare (d)	75	F5	} Number of bytes to be transferred	
	No Compare (d)	55	D5		
	Home Address	1A	9A		5
Sense	Count	12	92	8	
	Record 0	16	96	} Number of bytes to be transferred	
	Data	06	86		
	Key and Data	0E	8E		
	Count, Key and Data	1E	9E		
	IPL	02			1
	Sector (a,f)	22		1	
	Sense I/O	04		24 (a); 6 (d)	
Read, Reset Buffered Log (b)	A4		24		
Write	Read Buffered Log (c)	24		128	
	Device Release (e)	94		24 (a); 6 (d)	
	Device Reserve (e)	B4		24 (a); 6 (d)	
	Read Diagnostic Status 1 (a)	44		16 or 512	
	Home Address	19		5 (exc. 7 on 3340)	
Write	Record 0	15		8+KL+DL of R0	
	Erase	11		8+KL+DL	
	Count, Key and Data	1D		8+KL+DL	
	Special Count, Key and Data	01		8+KL+DL	
	Data	05		DL	
	Key and Data	0D		KL+DL	

* Code same as MT Off except as listed.

a. Except 2314, 2319.

b. 3330-3340 Series only; manual reset on 3340.

c. 2305/2835 only.

d. 2314, 2319 only.

e. String switch or 2-channel switch feature required; standard on 2314 with 2844.

f. Special feature required on 3340.

CODE TRANSLATION TABLE

Dec.	Hex	Instruction (RR)	Graphics and Controls			7-Track Tape BCDIC(2)	EBCDIC Card Code	Binary
			BCDIC	EBCDIC(1)	ASCII			
0	00			NUL	NUL		12-0-1-8-9	0000 0000
1	01			SOH	SOH		12-1-9	0000 0001
2	02			STX	STX		12-2-9	0000 0010
3	03			ETX	ETX		12-3-9	0000 0011
4	04	SPM		PF	EOT		12-4-9	0000 0100
5	05	BALR		HT	ENQ		12-5-9	0000 0101
6	06	BCTR		LC	ACK		12-6-9	0000 0110
7	07	BCR		DEL	BEL		12-7-9	0000 0111
8	08	SSK			BS		12-8-9	0000 1000
9	09	ISK			HT		12-1-8-9	0000 1001
10	0A	SVC		SMM	LF		12-2-8-9	0000 1010
11	0B			VT	VT		12-3-8-9	0000 1011
12	0C			FF	FF		12-4-8-9	0000 1100
13	0D			CR	CR		12-5-8-9	0000 1101
14	0E	MVCL		SO	SO		12-6-8-9	0000 1110
15	0F	CLCL		SI	SI		12-7-8-9	0000 1111
16	10	LPR		DLE	DLE		12-11-1-8-9	0001 0000
17	11	LNR		DC1	DC1		11-1-9	0001 0001
18	12	LTR		DC2	DC2		11-2-9	0001 0010
19	13	LCR		TM	DC3		11-3-9	0001 0011
20	14	NR		RES	DC4		11-4-9	0001 0100
21	15	CLR		NL	NAK		11-5-9	0001 0101
22	16	OR		BS	SYN		11-6-9	0001 0110
23	17	XR		IL	ETB		11-7-9	0001 0111
24	18	LR		CAN	CAN		11-8-9	0001 1000
25	19	CR		EM	EM		11-1-8-9	0001 1001
26	1A	AR		CC	SUB		11-2-8-9	0001 1010
27	1B	SR		CUJ	ESC		11-3-8-9	0001 1011
28	1C	MR		IFS	FS		11-4-8-9	0001 1100
29	1D	DR		IGS	GS		11-5-8-9	0001 1101
30	1E	ALR		IRS	RS		11-6-8-9	0001 1110
31	1F	SLR		IUS	US		11-7-8-9	0001 1111
32	20	LPDR		DS	SP		11-0-1-8-9	0010 0000
33	21	LNDR		SOS	'		0-1-9	0010 0001
34	22	LTDR		FS	"		0-2-9	0010 0010
35	23	LCDR			#		0-3-9	0010 0011
36	24	HDR		BYP	\$		0-4-9	0010 0100
37	25	LRDR		LF	%		0-5-9	0010 0101
38	26	MXR		ETB	&		0-6-9	0010 0110
39	27	MXDR		ESC	'		0-7-9	0010 0111
40	28	LDR			(0-8-9	0010 1000
41	29	CDR)		0-1-8-9	0010 1001
42	2A	ADR		SM	*		0-2-8-9	0010 1010
43	2B	SDR		CUZ	+		0-3-8-9	0010 1011
44	2C	MDR			,		0-4-8-9	0010 1100
45	2D	DDR		ENQ	-		0-5-8-9	0010 1101
46	2E	AWR		ACK	.		0-6-8-9	0010 1110
47	2F	SWR		BEL	/		0-7-8-9	0010 1111
48	30	LPER			0		12-11-0-1-8-9	0011 0000
49	31	LNER			1		1-9	0011 0001
50	32	LTER		SYN	2		2-9	0011 0010
51	33	LCER			3		3-9	0011 0011
52	34	HER		PN	4		4-9	0011 0100
53	35	LRER		RS	5		5-9	0011 0101
54	36	AXR		UC	6		6-9	0011 0110
55	37	SXR		EOT	7		7-9	0011 0111
56	38	LER			8		8-9	0011 1000
57	39	CER			9		1-8-9	0011 1001
58	3A	AER			:		2-8-9	0011 1010
59	3B	SER		CUZ	<		3-8-9	0011 1011
60	3C	MER		DC4	<		4-8-9	0011 1100
61	3D	DER		NAK	>		5-8-9	0011 1101
62	3E	AUR			>		6-8-9	0011 1110
63	3F	SUR		SUB	?		7-8-9	0011 1111

- Two columns of EBCDIC graphics are shown. The first gives standard bit pattern assignments. The second shows the T-11 and TN text printing chains (120 graphics).
- Add C (check bit) for odd or even parity as needed, except as noted.
- For even parity use CA.

TWO-CHARACTER BSC DATA LINK CONTROLS		
Function	EBCDIC	ASCII
ACK-0	DLE,X'70'	DLE,0
ACK-1	DLE,X'61'	DLE,1
WACK	DLE,X'6B'	DLE,;
RV1	DLE,X'7C'	DLE,<

CODE TRANSLATION TABLE (Contd)

Dec.	Hex	Instruction (RZ)	Graphics and Controls BCDIC EBCDIC(D) ASCII	7-Track Tape BCDIC(Z)	EBCDIC Card Code	Binary	
64	40	STH	Sp Sp	@	(3)	no punches	0100 0000
65	41	LA		A		12-0-1-9	0100 0001
66	42	STC		B		12-0-2-9	0100 0010
67	43	IC		C		12-0-3-9	0100 0011
68	44	EX		D		12-0-4-9	0100 0100
69	45	BAL		E		12-0-5-9	0100 0101
70	46	BCT		F		12-0-6-9	0100 0110
71	47	BC		G		12-0-7-9	0100 0111
72	48	LH		H		12-0-8-9	0100 1000
73	49	CH		I		12-1-8	0100 1001
74	4A	AH	¢ ¢	J		12-2-8	0100 1010
75	4B	SH		K	B A 8 2 1	12-3-8	0100 1011
76	4C	MH	□) < <	L	B A 8 4	12-4-8	0100 1100
77	4D		[((M	B A 8 4 1	12-5-8	0100 1101
78	4E	CVD	< + +	N	B A 8 4 2	12-6-8	0100 1110
79	4F	CVB	#	O	B A 8 4 2 1	12-7-8	0100 1111
80	50	ST	& + & &	P	B A	12	0101 0000
81	51			Q		12-11-1-9	0101 0001
82	52			R		12-11-2-9	0101 0010
83	53			S		12-11-3-9	0101 0011
84	54	N		T		12-11-4-9	0101 0100
85	55	CL		U		12-11-5-9	0101 0101
86	56	O		V		12-11-6-9	0101 0110
87	57	X		W		12-11-7-9	0101 0111
88	58	L		X		12-11-8-9	0101 1000
89	59	C		Y		11-1-8	0101 1001
90	5A	A	!	Z		11-2-8	0101 1010
91	5B	S	\$ \$ \$	[B 8 2 1	11-3-8	0101 1011
92	5C	M	* * *	\	B 8 4	11-4-8	0101 1100
93	5D	D]]]]]	B 8 4 1	11-5-8	0101 1101
94	5E	AL	; ; ;	^	B 8 4 2	11-6-8	0101 1110
95	5F	SL	Δ - -	-	B 8 4 2 1	11-7-8	0101 1111
96	60	STD	- - -	a	B	11	0110 0000
97	61		/ / /	b	A 1	0-1	0110 0001
98	62			c		11-0-2-9	0110 0010
99	63			d		11-0-3-9	0110 0011
100	64			e		11-0-4-9	0110 0100
101	65			f		11-0-5-9	0110 0101
102	66			g		11-0-6-9	0110 0110
103	67	MXD		h		11-0-7-9	0110 0111
104	68	LD		i		11-0-8-9	0110 1000
105	69	CD		j		0-1-8	0110 1001
106	6A	AD		k		12-11	0110 1010
107	6B	SD		l	A 8 2 1	0-3-8	0110 1011
108	6C	MD	% % %	m	A 8 4	0-4-8	0110 1100
109	6D	DD	Y	n	A 8 4 1	0-5-8	0110 1101
110	6E	AW	\ \ \	o	A 8 4 2	0-6-8	0110 1110
111	6F	SW	* ? ?		A 8 4 2 1	0-7-8	0110 1111
112	70	STE		p		12-11-0	0111 0000
113	71			q		12-11-0-1-9	0111 0001
114	72			r		12-11-0-2-9	0111 0010
115	73			s		12-11-0-3-9	0111 0011
116	74			t		12-11-0-4-9	0111 0100
117	75			u		12-11-0-5-9	0111 0101
118	76			v		12-11-0-6-9	0111 0110
119	77			w		12-11-0-7-9	0111 0111
120	78	LE		x		12-11-0-8-9	0111 1000
121	79	CE		y		1-8	0111 1001
122	7A	AE	b : :	z	A	2-8	0111 1010
123	7B	SE	# # #	{	8 2 1	3-8	0111 1011
124	7C	ME	@ @ @		8 4	4-8	0111 1100
125	7D	DE	: : :	}	8 4 1	5-8	0111 1101
126	7E	AU	√ = =	~	8 4 2	6-8	0111 1110
127	7F	SU	√ = =	DEL	8 4 2 1	7-8	0111 1111

CODE TRANSLATION TABLE (Contd)

Dec.	Hex	Instruction and Format	Graphics and Controls			7-Track Tape BCDIC(2)	EBCDIC Card Code	Binary
			BCDIC	EBCDIC(1)	ASCII			
128	80	SSM -S				12-0-1-8	1000 0000	
129	81		a	a		12-0-1	1000 0001	
130	82	LPSW -S	b	b		12-0-2	1000 0010	
131	83	Diagnose	c	c		12-0-3	1000 0011	
132	84	WRD } SI	d	d		12-0-4	1000 0100	
133	85	RDD } SI	e	e		12-0-5	1000 0101	
134	86	BXH } SI	f	f		12-0-6	1000 0110	
135	87	BXLE } SI	g	g		12-0-7	1000 0111	
136	88	SRL	h	h		12-0-8	1000 1000	
137	89	SLL	i	i		12-0-9	1000 1001	
138	8A	SRA				12-0-2-8	1000 1010	
139	8B	SLA -RS	f			12-0-3-8	1000 1011	
140	8C	SRDL	≤			12-0-4-8	1000 1100	
141	8D	SLDL	†			12-0-5-8	1000 1101	
142	8E	SRDA	+			12-0-6-8	1000 1110	
143	8F	SLDA	‡			12-0-7-8	1000 1111	
144	90	STM				12-11-1-8	1001 0000	
145	91	TM } SI	j	j		12-11-1	1001 0001	
146	92	MVI } SI	k	k		12-11-2	1001 0010	
147	93	TS -S	l	l		12-11-3	1001 0011	
148	94	NI	m	m		12-11-4	1001 0100	
149	95	CLI } SI	n	n		12-11-5	1001 0101	
150	96	OI } SI	o	o		12-11-6	1001 0110	
151	97	XI } SI	p	p		12-11-7	1001 0111	
152	98	LM -RS	q	q		12-11-8	1001 1000	
153	99		r	r		12-11-9	1001 1001	
154	9A					12-11-2-8	1001 1010	
155	9B		}			12-11-3-8	1001 1011	
156	9C	SIO, SIOF	□			12-11-4-8	1001 1100	
157	9D	TIO, CLRIO	†			12-11-5-8	1001 1101	
158	9E	HIO, HDV	±			12-11-6-8	1001 1110	
159	9F	TCH	■			12-11-7-8	1001 1111	
160	A0					11-0-1-8	1010 0000	
161	A1		~	°		11-0-1	1010 0001	
162	A2		s	s		11-0-2	1010 0010	
163	A3		t	t		11-0-3	1010 0011	
164	A4		u	u		11-0-4	1010 0100	
165	A5		v	v		11-0-5	1010 0101	
166	A6		w	w		11-0-6	1010 0110	
167	A7		x	x		11-0-7	1010 0111	
168	A8		y	y		11-0-8	1010 1000	
169	A9		z	z		11-0-9	1010 1001	
170	AA					11-0-2-8	1010 1010	
171	AB		⊥			11-0-3-8	1010 1011	
172	AC	STNSM } SI	r			11-0-4-8	1010 1100	
173	AD	STOSM } SI	[11-0-5-8	1010 1101	
174	AE	SIGP -RS	≥			11-0-6-8	1010 1110	
175	AF	MC -SI	●			11-0-7-8	1010 1111	
176	B0		0			12-11-0-1-8	1011 0000	
177	B1	LRA -RX	1			12-11-0-1	1011 0001	
178	B2	See below	2			12-11-0-2	1011 0010	
179	B3		3			12-11-0-3	1011 0011	
180	B4		4			12-11-0-4	1011 0100	
181	B5		5			12-11-0-5	1011 0101	
182	B6	STCTL } RS	6			12-11-0-6	1011 0110	
183	B7	LCTL } RS	7			12-11-0-7	1011 0111	
184	B8		8			12-11-0-8	1011 1000	
185	B9		9			12-11-0-9	1011 1001	
186	BA	CS } RS				12-11-0-2-8	1011 1010	
187	BB	CDS } RS	⌋			12-11-0-3-8	1011 1011	
188	BC		⌈			12-11-0-4-8	1011 1100	
189	BD	CLM } RS]			12-11-0-5-8	1011 1101	
190	BE	STCM } RS	⌘			12-11-0-6-8	1011 1110	
191	BF	ICM } RS	⌚			12-11-0-7-8	1011 1111	

Op code (S format)

B202 - STIDP	B207 - STCKC	B200 - PTLB
B203 - STIDC	B208 - SPT	B210 - SPX
B204 - SCK	B209 - STPT	B211 - STPX
B205 - STCK	B20A - SPKA	B212 - STAP
B206 - SCKC	B20B - IPK	B213 - RRB

CODE TRANSLATION TABLE (Contd)

Dec.	Hex	Instruction (ISS)	Graphics and Controls			7-Track Tape BCDIC(2)	EBCDIC Card Code	Binary
			BCDIC	EBCDIC(1)	ASCII			
192	C0		?	{		B A 8 2	12-0	1100 0000
193	C1		A	A	A	B A 1	12-1	1100 0001
194	C2		B	B	B	B A 2	12-2	1100 0010
195	C3		C	C	C	B A 2 1	12-3	1100 0011
196	C4		D	D	D	B A 4	12-4	1100 0100
197	C5		E	E	E	B A 4 1	12-5	1100 0101
198	C6		F	F	F	B A 4 2	12-6	1100 0110
199	C7		G	G	G	B A 4 2 1	12-7	1100 0111
200	C8		H	H	H	B A 8	12-8	1100 1000
201	C9		I	I	I	B A 8 1	12-9	1100 1001
202	CA						12-0-2-8-9	1100 1010
203	CB						12-0-3-8-9	1100 1011
204	CC						12-0-4-8-9	1100 1100
205	CD						12-0-5-8-9	1100 1101
206	CE			Y			12-0-6-8-9	1100 1110
207	CF						12-0-7-8-9	1100 1111
208	D0		!	}		B 8 2	11-0	1101 0000
209	D1	MVN	J	J	J	B 1	11-1	1101 0001
210	D2	MVC	K	K	K	B 2	11-2	1101 0010
211	D3	MVZ	L	L	L	B 2 1	11-3	1101 0011
212	D4	NC	M	M	M	B 4	11-4	1101 0100
213	D5	CLC	N	N	N	B 4 1	11-5	1101 0101
214	D6	OC	O	O	O	B 4 2	11-6	1101 0110
215	D7	XC	P	P	P	B 4 2 1	11-7	1101 0111
216	D8		Q	Q	Q	B 8	11-8	1101 1000
217	D9		R	R	R	B 8 1	11-9	1101 1001
218	DA						12-11-2-8-9	1101 1010
219	DB						12-11-3-8-9	1101 1011
220	DC	TR					12-11-4-8-9	1101 1100
221	DD	TRT					12-11-5-8-9	1101 1101
222	DE	ED					12-11-6-8-9	1101 1110
223	DF	EDMK					12-11-7-8-9	1101 1111
224	E0		#	\		A 8 2	0-2-8	1110 0000
225	E1						11-0-1-9	1110 0001
226	E2		S	S	S	A 2	0-2	1110 0010
227	E3		T	T	T	A 2 1	0-3	1110 0011
228	E4		U	U	U	A 4	0-4	1110 0100
229	E5		V	V	V	A 4 1	0-5	1110 0101
230	E6		W	W	W	A 4 2	0-6	1110 0110
231	E7		X	X	X	A 4 2 1	0-7	1110 0111
232	E8		Y	Y	Y	A 8	0-8	1110 1000
233	E9		Z	Z	Z	A 8 1	0-9	1110 1001
234	EA						11-0-2-8-9	1110 1010
235	EB						11-0-3-8-9	1110 1011
236	EC			H			11-0-4-8-9	1110 1100
237	ED						11-0-5-8-9	1110 1101
238	EE						11-0-6-8-9	1110 1110
239	EF						11-0-7-8-9	1110 1111
240	F0	SRP	0	0	0	8 2 0		1111 0000
241	F1	MVO	1	1	1	1 1		1111 0001
242	F2	PACK	2	2	2	2 2		1111 0010
243	F3	UNPK	3	3	3	2 1 3		1111 0011
244	F4		4	4	4	4 4		1111 0100
245	F5		5	5	5	4 1 5		1111 0101
246	F6		6	6	6	4 2 6		1111 0110
247	F7		7	7	7	4 2 1 7		1111 0111
248	F8	ZAP	8	8	8	8 8		1111 1000
249	F9	CP	9	9	9	8 1 9		1111 1001
250	FA	AP					12-11-0-2-8-9	1111 1010
251	FB	SP					12-11-0-3-8-9	1111 1011
252	FC	MP					12-11-0-4-8-9	1111 1100
253	FD	DP					12-11-0-5-8-9	1111 1101
254	FE						12-11-0-6-8-9	1111 1110
255	FF						12-11-0-7-8-9	1111 1111

ANSI-DEFINED PRINTER CONTROL CHARACTERS

(A in RECFM field of DCB)

Code	Action before printing record
blank	Space 1 line
0	Space 2 lines
-	Space 3 lines
+	Suppress space
1	Skip to line 1 on new page

MACHINE INSTRUCTION FORMATS

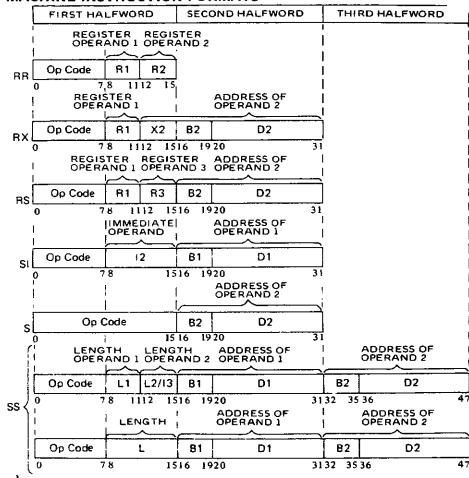

CONTROL REGISTERS

CR	Bits	Name of field	Associated with	Init.	
0	0	Block-multiplex'g control	Block-multiplex'g	0	
	1	SSM suppression control	SSM instruction	0	
	2	TOD clock sync control	Multiprocessing	0	
	8-9	Page size control	} Dynamic addr. transl.	0	
	10	Unassigned (must be zero)		0	
	11-12	Segment size control	} Multiprocessing	0	
	16	Malfunction alert mask		0	
	17	Emergency signal mask		0	
	18	External call mask		0	
	19	TOD clock sync check mask		0	
	20	Clock comparator mask		Clock comparator	0
	1	21	CPU timer mask	CPU timer	0
		24	Interval timer mask	Interval timer	1
		25	Interrupt key mask	Interrupt key	1
26		External signal mask	External signal	1	
1		0-7	Segment table length	} Dynamic addr. transl.	0
		8-25	Segment table address		0
2		0-31	Channel masks	Channels	1
8		16-31	Monitor masks	Monitoring	0
9		0	Successful branching event mask	} Program-event record'g	0
		1	Instruction fetching event mask		0
		2	Storage alteration event mask		0
		3	GR alteration event mask		0
		16-31	PER general register masks		0
10		8-31	PER starting address	Program-event record'g	0
11	8-31	PER ending address	Program-event record'g	0	
14	0	Check-stop control	} Machine-check handling	1	
	1	Synch. MCEL control		1	
	2	I/O extended logout control	} I/O extended logout	0	
	4	Recovery report mask		0	
	5	Degradation report mask	} Machine-check handling	0	
	6	Ext. damage report mask		1	
	7	Warning mask		0	
	8	Asynch. MCEL control		0	
	9	Asynch. fixed log control	0		
	15	8-28	MCEL address	Machine-check handling	512

PROGRAM STATUS WORD (BC Mode)

Channel masks	E	Protect'n key	CMWP	Interruption code						
0	6	7	8	11	12	15	16	23	24	31
ILC	CC	Program mask	Instruction address							
32	34	36	39	40	47	48	55	56	63	

0-5 Channel 0 to 5 masks
 6 Mask for channel 6 and up
 7 (E) External mask
 12 (C=0) Basic control mode
 13 (M) Machine-check mask
 14 (W=1) Wait state
 15 (P=1) Problem state

32-33 (ILC) Instruction length code
 34-35 (CC) Condition code
 36 Fixed-point overflow mask
 37 Decimal overflow mask
 38 Exponent underflow mask
 39 Significance mask

PROGRAM STATUS WORD (EC Mode)

OR00	OTIE	Protect'n key	CMWP	00	CC	Program mask	0000	0000			
0	7	8	11	12	15	16	18	20	23	24	31
0000		0000		Instruction address							
32	39	40	47	48	55	56	63				

1 (R) Program event recording mask
 5 (T=1) Translation mode
 6 (I) Input/output mask
 7 (E) External mask
 12 (C=1) Extended control mode
 13 (M) Machine-check mask
 14 (W=1) Wait state

15 (P=1) Problem state
 18-19 (CC) Condition code
 20 Fixed-point overflow mask
 21 Decimal overflow mask
 22 Exponent underflow mask
 23 Significance mask

CHANNEL COMMAND WORD

Command code	Data address							
0	7	8	15	16	23	24	31	
Flags	00	/ / / / / / / /			Byte count			
32	37	38	40	47	48	55	56	63

CD-bit 32 (80) causes use of address portion of next CCW.
 CC-bit 33 (40) causes use of command code and data address of next CCW.
 SLI-bit 34 (20) causes suppression of possible incorrect length indication.
 Skip-bit 35 (10) suppresses transfer of information to main storage.
 PCI-bit 36 (08) causes a channel program controlled interruption.
 IDA-bit 37 (04) causes bits 8-31 of CCW to specify location of first IDAW.

CHANNEL STATUS WORD (hex 40)

Key	0	L	CC	CCW address							
0	3	4	5	6	7	8	15	16	23	24	31
Unit status		Channel status		Byte count							
32	39	40	47	48	55	56	63				

5 Logout pending
 6-7 Deferred condition code
 32 (80) Attention
 33 (40) Status modifier
 34 (20) Control unit end
 35 (10) Busy
 36 (08) Channel end
 37 (04) Device end
 38 (02) Unit check
 39 (01) Unit exception

40 (80) Program-controlled interruption
 41 (40) Incorrect length
 42 (20) Program check
 43 (10) Protection check
 44 (08) Channel data check
 45 (04) Channel control check
 46 (02) Interface control check
 47 (01) Chaining check
 48-63 Residual byte count for the last CCW used

PROGRAM INTERRUPTION CODES

0001	Operation exception	000C	Exponent overflow excp
0002	Privileged operation excp	000D	Exponent underflow excp
0003	Execute exception	000E	Significance exception
0004	Protection exception	000F	Floating-point divide excp
0005	Addressing exception	0010	Segment translation excp
0006	Specification exception	0011	Page translation exception
0007	Data exception	0012	Translation specification excp
0008	Fixed-point overflow excp	0013	Special operation exception
0009	Fixed-point divide excp	0040	Monitor event
000A	Decimal overflow exception	0080	Program event (code may be combined with another code)
000B	Decimal divide exception		

FIXED STORAGE LOCATIONS

Area, dec.	Hex addr	EC only	Function
0-7	0		Initial program loading PSW, restart new PSW
8-15	8		Initial program loading CCW1, restart old PSW
16-23	10		Initial program loading CCW2
24-31	18		External old PSW
32-39	20		Supervisor Call old PSW
40-47	28		Program old PSW
48-55	30		Machine-check old PSW
56-63	38		Input/output old PSW
64-71	40		Channel status word (see diagram)
72-75	48		Channel address word [0-3 key, 4-7 zeros, 8-31 CCW address]
80-83	50		Interval timer
88-95	58		External new PSW
96-103	60		Supervisor Call new PSW
104-111	68		Program new PSW
112-119	70		Machine-check new PSW
120-127	78		Input/output new PSW
132-133	84		CPU address assoc'd with external interruption, or unchanged
132-133	84	X	CPU address assoc'd with external interruption, or zeros
134-135	86	X	External interruption code
136-139	88	X	SVC interruption [0-12 zeros, 13-14 ILC, 15-0, 16-31 code]
140-143	8C	X	Program interrupt. [0-12 zeros, 13-14 ILC, 15-0, 16-31 code]
144-147	90	X	Translation exception address [0-7 zeros, 8-31 address]
148-149	94		Monitor class [0-7 zeros, 8-15 class number]
150-151	96	X	PER interruption code [0-3 code, 4-15 zeros]
152-155	98	X	PER address [0-7 zeros, 8-31 address]
156-159	9C		Monitor code [0-7 zeros, 8-31 monitor code]
168-171	A8		Channel ID [0-3 type, 4-15 model, 16-31 max. IOEL length]
172-175	AC		I/O extended logout address [0-7 unused, 8-31 address]
176-179	B0		Limited channel logout (see diagram)
185-187	B9	X	I/O address [0-7 zeros, 8-23 address]
216-223	D8		CPU timer save area
224-231	E0		Clock comparator save area
232-239	E8		Machine-check interruption code (see diagram)
248-251	F8		Failing processor storage address [0-7 zeros, 8-31 address]
252-255	FC		Region code*
256-351	100		Fixed logout area*
352-383	160		Floating-point register save area
384-447	180		General register save area
448-511	1C0		Control register save area
512†	200		CPU extended logout area (size varies)

* May vary among models; see system library manuals for specific model.

† Location may be changed by programming (bits 8-28 of CR 15 specify address).

LIMITED CHANNEL LOGOUT (hex B0)

0	SCU id	Detect	Source	000	Field validity flags	TT	00	A	Seq.
0 1	3 4	7 8	12 13	15 16	23 24	26	28 29	31	
4	CPU		12	Control unit	24-25	Type of termination			
5	Channel		16	Interface address	00	Interface disconnect			
6	Main storage control		17-18	Reserved (00)	01	Stop, stack or normal			
7	Main storage		19	Sequence code	10	Selective reset			
8	CPU		20	Unit status	11	System reset			
9	Channel		21	Cmd. addr. and key	28(A)	I/O error alert			
10	Main storage control		22	Channel address	29-31	Sequence code			
11	Main storage		23	Device address					

MACHINE-CHECK INTERRUPTION CODE (hex E8)

MC conditions	000	.00	Time	Stg. error	0	Validity indicators
0	8 9	13 14	16	18 19	20	31
0000	0000	0000	00	Val.		MCEL length
32	39 40	45 46	48	55 56		63
0	System damage	14	Backed-up	24	Failing stg. address	
1	Instr. proc'g damage	15	Delayed	25	Region code	
2	System recovery	16	Uncorrected	27	Floating-pt registers	
3	Timer damage	17	Corrected	28	General registers	
4	Timing facil. damage	18	Key uncorrected	29	Control registers	
5	External damage	20	PSW bits 12-15	30	CPU ext'd logout	
6	Not assigned (0)	21	PSW masks and key	31	Storage logical	
7	Degradation	22	Prog. mask and CC	46	CPU timer	
8	Warning	23	Instruction address	47	Clock comparator	

DYNAMIC ADDRESS TRANSLATION

VIRTUAL (LOGICAL) ADDRESS FORMAT

Segment Size	Page Size	Bits	Segment Index	Page Index	Byte Index
64K	4K	0 - 7	8 - 15	16 - 19	20 - 31
64K	2K	are	8 - 15	16 - 20	21 - 31
1M	4K	ignored	8 - 11	12 - 19	20 - 31
1M	2K	ignored	8 - 11	12 - 20	21 - 31

SEGMENT TABLE ENTRY

PT length	0000*	Page table address	00*
0	3 4	7 8	28 29 31

*Normally zeros; ignored on some models.

31 (I) Segment-invalid bit.

PAGE TABLE ENTRY (4K)

Page address		00	/
0	11 12 13	15	0

12 (I) Page-invalid bit.

PAGE TABLE ENTRY (2K)

Page address		0	/
0	12 13 14 15	0	

13 (I) Page-invalid bit.

HEXADECIMAL AND DECIMAL CONVERSION

From hex: locate each hex digit in its corresponding column position and note the decimal equivalents. Add these to obtain the decimal value.

From decimal: (1) locate the largest decimal value in the table that will fit into the decimal number to be converted, and (2) note its hex equivalent and hex column position. (3) Find the decimal remainder. Repeat the process on this and subsequent remainders.

Note: Decimal, hexadecimal, (and binary) equivalents of all numbers from 0 to 255 are listed on panels 9 - 12.

HEXADECIMAL COLUMNS					
6	5	4	3	2	1
HEX = DEC	HEX = DEC	HEX = DEC	HEX = DEC	HEX = DEC	HEX = DEC
0	0	0	0	0	0
1	1,048,576	1 65,536	1 4,096	1 256	1 16
2	2,097,152	2 131,072	2 8,192	2 512	2 32
3	3,145,728	3 196,608	3 12,288	3 768	3 48
4	4,194,304	4 262,144	4 16,384	4 1,024	4 64
5	5,242,880	5 327,680	5 20,480	5 1,280	5 80
6	6,291,456	6 393,216	6 24,576	6 1,536	6 96
7	7,340,032	7 458,752	7 28,672	7 1,792	7 112
8	8,388,608	8 524,288	8 32,768	8 2,048	8 128
9	9,437,184	9 589,824	9 36,864	9 2,304	9 144
A	10,485,760	A 655,360	A 40,960	A 2,560	A 160
B	11,534,336	B 720,896	B 45,056	B 2,816	B 176
C	12,582,912	C 786,432	C 49,152	C 3,072	C 192
D	13,631,488	D 851,968	D 53,248	D 3,328	D 208
E	14,680,064	E 917,504	E 57,344	E 3,584	E 224
F	15,728,640	F 983,040	F 61,440	F 3,840	F 240
0 1 2 3	4 5 6 7	0 1 2 3	4 5 6 7	0 1 2 3	4 5 6 7
BYTE		BYTE		BYTE	

POWERS OF 2

2 ⁿ	n
256	8
512	9
1 024	10
2 048	11
4 096	12
8 192	13
16 384	14
32 768	15
65 536	16
131 072	17
262 144	18
524 288	19
1 048 576	20
2 097 152	21
4 194 304	22
8 388 608	23
16 777 216	24

POWERS OF 16

16 ⁿ	n
1	0
16	1
256	2
4 096	3
65 536	4
1 048 576	5
16 777 216	6
268 435 456	7
4 294 967 296	8
68 719 476 736	9
1 099 511 627 776	10
17 592 186 044 416	11
281 474 976 710 656	12
4 503 599 627 370 496	13
72 057 594 037 927 936	14
1 152 921 504 606 846 976	15

Section 3 Contents

Section 3: CPU Manual Procedure:	3-1
Functional Characteristics of Manual Controls	3-1
CPU Manual Procedures for:	
Mod 115	3-3
Mod 125	3-3
Mod 135	3-6
Mod 145	3-8
Mod 155	3-11
Mod 158	3-13
Mod 165	3-15
Mod 168	3-18
Mod 195	3-22

Functional Characteristics of Manual Controls

Source: GA22-7000 IBM System/370 Principles of Operation

The manual controls provided on the System/370 system console vary according to model. This list defines the functions of S/370 manual controls generally.

POWER-ON pushbutton	Starts a power-on sequence. Lights up red, light turns white after 30 seconds. Clear system reset occurs. System enters manual stop condition.
POWER-OFF key	Initiates a power-off sequence when the power-on key is lighted white or red.
START key	Starts instruction execution. Effective only if CPU is in stopped state.
STOP key	Puts CPU in stopped state.
RESTART key	Initiates restart interruption. Effective in both operating and stopped states.
EMERGENCY PULL switch	Turns off all power beyond the power-entry terminal on every unit that is part of the system or can be switched onto the system.
IMPL controls	Model dependent. Used for initial microprogram loading.
LOAD key	Loads an IPL program.
LOAD indicator	Goes on when the LOAD key is pressed, goes off when the IPL chain is broken.
LOAD UNIT-ADDRESS controls	Tells the system where to get the IPL program when you push the LOAD key.
TOD CLOCK key	Must be in ENABLE position to set clock.
DISPLAY and ENTER controls	Control of these functions on some models is on the system control panel; on other models, by use of console devices. CPU must first be placed in stopped state. Using these controls, you can display and enter information in main storage, in the general, floating-point, and control registers, the PSW, and the keys in storage.
ADDRESS COMPARE switch	Stops the CPU when it reaches any address you select in advance. Settings can be changed without disrupting CPU operations other than the stop.
INTERRUPT key	Interrupts program execution by causing an external interruption. Interrupt is taken when CPU is in operating state, otherwise it remains pending.
SYSTEM RESET key	Interrupts instruction processing and resets the CPU, channels, storage units and other CPU's.
ENABLE SYSTEM-CLEAR key	In conjunction with SYSTEM RESET key, resets the CPU, channels, -on-line nonshared control units, and I/O devices; and, in most models, clears registers to zeros. In conjunction with LOAD key, does the same except you must re-IPL.
RATE CONTROL	Sets the rate the CPU will operate at: PROCESS rate, normal speed; INSTRUCTION STEP rate, one whole instruction per push of the START key. Set when CPU is in stopped state. TEST indicator lights when RATE CONTROL is not set to PROCESS.

TEST indicator	Goes on when a manual control is not in its normal position or when a maintenance function is being performed for the CPU, channels, or storage.
STORE-STATUS key	Initiates store-status function. Function initiated on some models by pushbutton, on others by use of a special keyboard mnemonic or by CRT-menu selection. Effective only when CPU is in stopped state.
MANUAL indicator	Goes on when CPU is in stopped state.
WAIT indicator	Goes on when the CPU is in the wait state.
CHECK-STOP indicator	Goes on when the CPU is in the check-stop state. A CPU reset will turn it off.
THERMAL/CB POWER-CHECK indicator	Goes on when a thermal condition or a circuit-breaker trip, or both, are detected in the CPU complex. Turned off from CE power control panel.
SYSTEM indicator	Goes on when the CPU cluster meter or customer-engineer meter is running.

System/370 Model 115 and Model 125

Sources: GA33-1510 System/370 Model 115 Functional Characteristics
GA33-1509 System/370 Model 125 Procedures

Power-On Procedure

DANGER: Before switching on power, ensure that no person is exposed to risk and that all equipment covers are shut.

1. Ensure system diskette is inserted in console file.
2. Press POWER ON. Red light comes on.
3. IMPL is automatic if diskette is loaded as described in step 1. If not, wait 30 seconds for white light on POWER ON before IMPLing.

Power-Off Procedure

Before removing power:

1. Issue any special commands your operating system requires.
2. Unload tape units and disk drives.
3. Perform 'save usage counters' if needed.
4. Press POWER OFF. The Power-On key turns from white to red, then goes out.

To IMPL

1. Place Control diskette in the 33FD.
2. Press IMPL key. This loads all microprograms from the console file into subprocessors which have loadable control storages. A malfunction in the console file causes the File Check light to turn on.
3. During IMPL, 'IMPL IN PROGRESS' appears on the video screen.
4. 'SUCCESSFULLY LOADED' appears when loading is finished. The next message, 'PROGRAM LOAD', is the signal to begin the IPL procedure.

To IPL for First Time after Power-On

1. Key in specifications as soon as PROGRAM LOAD is displayed on line 13 of the screen.
2. Press ENTER.

NOTE: If message 'IPL ERROR' or 'EC PSW ERR' appears on line 13 of the screen, reload with correct program. Press ENTER.

3. Proceed with usual operating procedures. Check for normal states across entire system.
4. Assign devices and start running jobs.

To Re-IPL

1. In order to get the PROGRAM LOAD display, press MODE SEL, key in L, and press ENTER. Specifications from the last IPL will be displayed.
2. If the specifications are to remain the same, press ENTER. If not, make changes and press ENTER.
3. Proceed with usual operating procedures. Check for normal states across entire system.
4. Assign devices and start running jobs.

System/370 Model 115 and Model 125 (cont'd)

To Display Registers, PSW, and Main Storage

1. Select ALTER/DISPLAY by keying A in the MODE SELECTION display and pressing ENTER.

```

                *MODE SELECTION*

R  SYSTEM RESET           A  ALTER/DISPLAY
C  ADDRESS COMPARE       I  INSTRUCTION STEP
L  PROGRAM LOAD          P  RESTART
T  INTERVAL TIMER       M  MAINTENANCE
K  CHECK CONTROL        S  STORE STATUS
D  STORAGE DUMP         U  SAVE USAGE COUNTERS
E  ICA LINE MODES

                MODE SPECIFICATION**--**

```

2. Select the desired display from those listed on the ALTER/DISPLAY frame.

```

                *ALTER/DISPLAY*

G  GENERAL REGISTERS
C  CONTROL REGISTERS
P  CURRENT PSW
F  FLOATING POINT REGS   STORAGE ADDRESS
K  PROTECTION KEY       000000—FFFFFF
M  MAIN STORAGE KEY     000000—FFFFFF
V  MAIN STORAGE VIRTUAL 000000—FFFFFF
MODE SPECIFICATION:    ADDRESS:

```

3. Key in the selector character: G for General-Purpose Register, P for Current PSW, etc. With Main Storage and Protection Key you must also key in the address.
4. Press ENTER.

To Alter Registers, PSW, and Main Storage

1. To change one or more of the digits in the display, move the cursor under the first digit to be changed.
2. Key in the new data. The new data appears on the line under the old data.
3. Before ENTER is pressed you can still change your input by using the cursor keys and entering the changes in the usual way.
4. Press ENTER. The new data replaces the old on the screen.

NOTE: If INVALID CHARACTER appears on the screen, you entered a wrong character (either a nonhexadecimal or a nonbinary). The cursor marks the first invalid character. Key in the correct information and press ENTER.

Procedure after an Alter/Display

1. Press MODE SEL to get the ALTER/DISPLAY frame again; or
2. Press MODE SEL twice to get the MODE SELECTION frame; or
3. Press CNCL key to return the screen to the operating system and the START key to resume processing.

System/370 Model 115 and Model 125 (cont'd)

To Stop on Main Storage Address

1. Press MODE SEL. This brings the main set of modes to the screen.
2. Key in C on the MODE SELECT display to display ADDRESS COMPARE.
3. Press ENTER.
4. ADDRESS COMPARE shows 3 columns: Action, Compare Type, and Storage Address.
5. Key in S (stop) for Action; D (data store) for Compare Type, and search address (6-digit hex number). The machine will stop at that address.

To Clear Main Storage

Clear Reset is used normally only by the CE, but may be used by the operator if a machine error is suspected.

1. Press MODE SEL.
2. Key in RC.
3. Press ENTER.

This clears all of main storage, the registers, and PSW. All timers except TOD clock are reset. The channels and CPU are reset and control registers are initialized.

When 'RESET COMPLETE' appears on the screen,

4. Press the CNCL and START keys to release the screen to the operating system and resume processing.
5. Continue operating.

System/370 Model 135

Source: GC38-0005 System/370 Model 135 Procedures

Power-On Procedure

DANGER: Before switching on power, ensure that no person is exposed to risk and that all equipment covers are shut.

1. Ensure that console file contains IMPL disk (green label) and console file cover is properly closed.
2. Press POWER ON, and wait two minutes.
3. Press LAMP TEST to check lamps.
4. System is ready when POWER ON white light is on.

Power-Off Procedure

1. Preparatory to turning power off:
 - a. Unload all disk and tape drives.
 - b. Open or disengage the print unit release lever on all printers using print train cartridges.
2. Depress the POWER OFF pushbutton.

To IMPL

CAUTION: Do not ready any I/O devices during IMPL.

1. Ensure that switches are set to normal positions, console file contains IMPL disk (green label), and console-printer keyboard is ready.
2. Press START CONSOLE FILE. Light changes from red to white to off.
3. Wait for IMPL REQD indicator to go off and the MAN indicator to turn on before IPLing.

To IPL

1. Ensure that IMPL REQD indicator is off, switches are set to normal positions, and MAN indicator is on.
2. Load and make ready the IPL input device.
3. Select IPL input device address on rotary switches C through E (LOAD UNIT ADDRESS).
4. Press LOAD.
5. Begin operating system procedures. Check for normal status of entire system before running jobs.
6. Assign devices and start running jobs.

Loading the Secondary Nucleus (OS)

1. Place the program to the desired I/O device and make that device ready.
2. Set the three LOAD UNIT ADDRESS switches to the SYSRES address.
3. Set RATE switch to INSTRUCTION STEP.
4. Press LOAD button. Load light comes on and system goes into manual state.
5. Press Alter/Display Mode on PR-KB. Enter in location X'08' the EBCDIC character to be appended by IEANUCO. The two hex digits may range from F2 to F9 (determined by last character of nucleus name).
6. Set RATE switch to PROCESS.
7. Press START.

To Display Registers, PSW, and Main Storage

1. Press STOP and wait until MAN indicator comes on.
2. Press ALTER/DISPLAY at console-printer keyboard and wait until PROCEED light comes on.
3. Type 2-character mnemonic (D plus appropriate second letter) and hex address. No address is necessary after P (PSW) and T (Store Status).
4. After contents are displayed, press END at console-printer keyboard.
5. To resume operations, press START.

System/370 Model 135 (cont'd)

ALTER/DISPLAY CHART

Mnemonic		Function/Storage Type	Address Range (Model Dependent)	
Alter	Display			
AM	DM	Main storage	000000-07FFFF	Use the number of digits indicated. If necessary, complete the correct number of digits by inserting zeros as appropriate
†	DS	Control storage	0000-DFFE*	
AG	DG	General register	0-F	
AF	DF	Floating-point register	0,2,4,6	
AP	DP	Program status word	None	
AC	DC	Control register	0-F	
AK	DK	Storage key	000000-07FFFF	
AR	DR	Transmission rate ††	1-8 (line number)	
AV	DV	Virtual storage **	000000-FFFFFF	
ST		Store status	None	

To Alter Registers, PSW, and Main Storage

1. Press STOP and wait until MAN indicator comes on.
2. Press ALTER/DISPLAY at console-printer keyboard and wait until the PROCEED light comes on.
3. Select a 2-character mnemonic (A plus appropriate second letter) from the Alter/Display Mnemonics chart, and type the mnemonic and hex address.
4. Enter new characters in positions occupied by characters to be replaced. Reach required positions by repeating characters. In the case of the current PSW, retype up to and including the new bits desired, and press RETURN. It is unnecessary to retype the remaining bits.
5. Press END at console-printer keyboard.
6. Press START to resume operations.

To Stop on Main Storage Address

1. Press STOP.
2. Set STORAGE SELECT to MAIN STORAGE.
3. Set INTERVAL TIMER switch to DISABLE (if required).
4. Set STORAGE ADDRESS rotary switches A through E to desired address.
5. Set COMPARE ADDRESS to ANY.
6. Set appropriate ADDRESS COMPARE CONTROL switch to STOP.
7. Press START.

To resume normal processing after CPU stops at the desired address:

1. Set ADDRESS COMPARE to ANY, ADDRESS COMPARE CONTROL to SYNC/NORMAL, NORMAL INTERVAL TIMER to NORMAL (if required).
2. Press START.

To Clear Main Storage

The need for this procedure is indicated by a message at the console-printer keyboard or by an unexplained CPU wait state (WAIT indicator on).

1. Press and hold in ENABLE SYSTEM CLEAR.
2. Press SYSTEM RESET (once only).
3. Release ENABLE SYSTEM CLEAR.
4. Perform IPL procedure.
5. Continue normal processing.

Hard Stop Option

1. The hardstop indicator (white light) comes on whenever the CPU stops. CPU hardware errors are recorded in a log area of main storage by the CPU. If the software does not create an Environmental Data Recording Set (ERDS), run the SEREP (stand-alone) program to obtain a printout of the latest error information. Keep the EREP or SEREP printouts because they are useful to the CE.
2. On advice of the CE you may then set the CHECK CONTROL switch to CONDITIONAL HARD STOP and operate the CPU.

System/370 Model 145

Source GC38-0015 System/370 Model 145 Operating Procedures

Power-On Procedure

DANGER: Before switching on power, ensure that no person is exposed to risk and that all equipment covers are shut.

1. Insert *370 microprogram disk in console file and close cover.
2. Press the POWER ON key.
3. IMPL is automatic if:
 - a. Rotary switches are in their normal processing positions,
 - b. the ADDRESS COMPARE CONTROL switch is set to SYNC/NORM,
 - c. *370 microprogram disk is mounted in the console file,
 - d. console printer has paper and is ready to print the IMPL GO-NO GO-COMPLETE message.

This ends the Power-On procedure for MOD 145--No Feature Installed. For MOD 145 with CTCA or ISC feature, continue with steps specified under that feature.

Mod 145--Channel-to-Channel Adapter (CTCA) Feature Installed

4. Wait for I/O INFC DSBLD indicator to turn on.
5. Move the I/O INTERFACE switch to the ENABLE position. The adapter is available to the program when the I/O INFC DSBLD indicator turns off.

Mod 145--Integrated Storage Control (ISC) Feature Installed

4. Wait for the IMPL REQD indicator to turn off.
5. Move the I/O INTERFACE A and B switches to the ON position. The ISC is available to the program when the I/O INTFS DSBLD indicator turns off.

Power-Off Procedure

1. Preparatory to turning power off:
 - a. Unload all disk and tape drives.
 - b. Open or disengage the print unit release lever on all printers using print train cartridges.
2. Continue with steps applicable to your system.

Mod 145--No Features Installed

3. Press the STOP key.
4. Press the POWER-OFF key. NOTE: Do not turn power back on for at least ten seconds.

Mod 145--Channel-to-Channel Adapter (CTCA) Feature Installed

3. Inform the operator of the other system that the channel-to-channel adapter is to be removed from use.
4. Move the I/O INTERFACE switch to the DISABLE position.
5. Wait for the I/O INFC DSBLD indicator to turn on.
6. Press the POWER OFF key. NOTE: Do not turn power back on for at least ten seconds.

Mod 145--Integrated Storage Control (ISC) Feature Installed

3. Inform the operator of the other system that the ISC feature is to be removed from use (if applicable).
4. Move the I/O INTERFACE A and B switches to the OFF position.
5. Wait for the I/O INTFS DSBLD indicator to turn on.
6. Press the POWER OFF key. NOTE: Do not turn power back on for at least ten seconds.

System/370 Model 145 (cont'd)

To IMPL

1. Ensure that forms are inserted in the console printer and the *370 micro-program disk is mounted in the console file.
2. Set all rotary switches to their normal operating position. Ensure that the ADDRESS COMPARE CONTROL toggle switch is set to SYNC/NORM.
3. If power is not on, press POWER-ON key. IMPL occurs automatically. If power is on, press START CONSOLE FILE key to initiate the IMPL.
4. The IMPL REQD and CF POWER ON indicators turn on. The START CONSOLE key turns red, then white, as the console file starts reading.
5. The console file powers off automatically when control storage is loaded, and the CF POWER ON indicator and START CONSOLE FILE key light turn off.
The System Reset routine executes, the IMPL REQD indicator turns off, and the CPU enters the soft-stop state (MAN indicator on). IMPL operation takes approximately 35 seconds.

To IPL

1. Load and ready the System Resident (SYSRES) device.
2. Dial the address of the IPL device into LOAD UNIT ADDRESS switches FGH.
3. Press the LOAD key. After an automatic system reset, the IPL operation starts and the LOAD indicator turns on.
4. When the IPL is complete, the LOAD indicator turns off and the system either executes the program or enters the soft-stop state, awaiting your action.

Loading the Secondary Nucleus (OS)

1. Place the program to the desired I/O device and make that device ready.
2. Set the three LOAD UNIT ADDRESS switches to the SYSRES address.
3. Set RATE switch to INSTRUCTION STEP.
4. Press LOAD button. Load light comes on and system goes into manual state.
5. Press Alter/Display Mode on PR-KB. Enter in location X'08' the EBCDIC character to be appended by IEANUCO. The two hex digits may range from F2 to F9 (determined by last character of nucleus name).
6. Set RATE switch to PROCESS.
7. Press START.

To Display Registers, PSW, and Main Storage

Display operations can be performed from the PR-KB.

1. Press the STOP key or set the RATE switch to either INSTRUCTION STEP or SINGLE CYCLE HARD STOP.
2. Press the ALTER/DISPLAY key.
3. Wait for both ALTER/DISPLAY MODE and PROCEED indicators to turn on.
4. Select from the Alter/DISPLAY chart below the appropriate 2-character mnemonic, and type the mnemonic and address of the information to be displayed.
5. When zeros are typed to the left of the address, a new line operation is started automatically. When zeros are not inserted, the RETURN key must be pressed.
6. To continue program processing after the display operation is completed, return the RATE switch to PROCESS and press the Start key.

System/370 Model 145 (cont'd)

Alter/Display Chart

STORAGE AREA	ALTER MNEMONIC	DISPLAY MNEMONIC	ADDRESS RANGE
MAIN STORAGE	AM	DM	000000-0FFFFFF*
STORAGE KEY	AK	DK	000000-0FFFFFF*
CONTROL REGISTER	AC	DC	0-F
GENERAL REGISTER	AG	DG	0-F
FLOATING-POINT REGISTER	AF	DF	0,2,4,6
CURRENT PSW	AP	DP	None required
STORE STATUS	NONE	ST	None required
VIRTUAL STORAGE	AV	DV	000000-FFFFFF

*The upper boundary is movable and depends upon the capacity of main storage.

To Alter Registers, PSW, and Main Storage

1. Alter operations can be performed from the PR-KB. Press the STOP key or set the RATE switch to either INSTRUCTION STEP or SINGLE CYCLE HARD STOP.
2. Press the ALTER/DISPLAY key.
3. Wait for both the ALTER/DISPLAY MODE and PROCEED indicators to turn on.
4. Select the appropriate 2-character mnemonic from the Alter/Display chart and type the mnemonic and address of the information to be altered.
5. Enter data, using the space bar to skip over positions not being altered. The data in the skipped-over positions remains unchanged and prints out each time the space bar is operated.
6. To end the alter operation, press the ALTER/DISPLAY key or the END key.
7. To resume program processing, return the RATE switch to PROCESS and press the START key.

To Stop on Main Storage Address

1. Press STOP key. MAN indicator comes on.
2. Set STORAGE SELECT switch to MAIN STORAGE position.
3. Set main storage address in STORAGE SELECT rotary switches CDEFGH.
4. Set ADDRESS COMPARE to ANY. NOTE: To guarantee a match on instruction addresses, the I-COUNTER position (real or logical) must be used.
5. Set ADDRESS COMPARE CONTROL toggle switch to STOP.
6. Press START key.

TO Clear Main Storage

1. Hold the ENABLE SYSTEM CLEAR key in the operated position.
2. Press the SYSTEM RESET or LOAD key.
3. Release the ENABLE SYSTEM CLEAR key.

Hard Stop Option

On getting a red light error and at the suggestion of service personnel:

1. Set CHECK CONTROL switch to STOP AFTER LOG. The LOG PRES indicator comes on after an error occurs and the machine stops.
2. IPL the SEREP deck and save printout for CE.
3. Press SYSTEM RESET and begin operating.
4. Should second error occur, call CE.

System/370 Model 155

Source: GA22-6966 System/370 Model 155 Operating Procedures

Power-On Procedure

DANGER: Before switching on power, ensure that no person is exposed to risk and that all equipment covers are shut.

1. Press the POWER-ON key. The key backlights red when pressed and turns white when the power-on sequence is complete.

Power-Off Procedure

1. Preparatory to turning power off:
 - a. Unload all disk and tape drives.
 - b. Open or disengage the print release lever on all printers that use print train cartridges.
2. Press the CPU STOP key.
3. Press the POWER-OFF key. This removes power from the CPU and online I/O units.

To IPL

1. Load and ready the IPL device.
2. Dial the address of the IPL device into LOAD UNIT switches FGH.
3. Press the LOAD key. The LOAD indicator turns on.
4. When IPL is complete, the LOAD indicator turns off and the system either executes the program or enters the soft-stop state, awaiting operator action.

Loading a Secondary Nucleus (OS)

After step 2 above.

1. Set RATE mode switch to INSN STEP.
2. Press the LOAD key.
3. Alter storage location 08 to the two hex digits designating the secondary nucleus. The two hex digits may range from F2 to F9 (determined by last character of nucleus name).
4. Set RATE switch to PROCESS.
5. Press START key.

To Display Registers, PSW, and Main Storage

Display operations are performed through the PR-KB.

1. Press the CPU STOP key (machine in manual state).
2. Press the ALTER/DISPLAY key.
3. Wait for both ALT/DISP MODE and PROCEED to turn on.
4. Select the 2-character mnemonic (D plus the appropriate second letter) from the Alter/Display chart, and type the mnemonic and the address of the information to be displayed.
5. When you type zeros to the left of the address, the operation is started automatically. If you do not type zeros, press the RETURN key to start display.
6. Data is printed starting at the address specified and continues until the ALTER/DISPLAY or END key is pressed.

NOTE: For Alter/Display of general-purpose and floating-point registers, a wraparound is performed (F to 0 for GP registers and 6 to 0 for floating-point registers).

7. Press ALTER/DISPLAY key for the PR-KB to remain in alter/display mode (ALT/DISP MODE indicator stays on), or press the END key to terminate alter/display mode.

System/370 Model 155 (cont'd)

ALTER/DISPLAY CHART

STORAGE AREA	ALTER MNEMONIC	DISPLAY MNEMONIC	ADDRESS RANGE
MAIN STORAGE	AM	DM	000000-FFFFFF
GENERAL-PURPOSE REGISTER	AG	DG	0-F
FLOATING-POINT REGISTER	AF	DF	0,2,4,6
CURRENT PSW	AP	DP	NONE REQUIRED
CONTROL REGISTERS	AC	DC	0-F

To Alter Registers, PSW, and Main Storage

1. Press the CPU STOP key (machine in manual state).
2. Press the ALTER/DISPLAY key.
3. Wait for both ALT/DISP MODE and PROCEED to turn on.
4. Select the 2-character mnemonic (A plus the appropriate second letter) from the Alter/Display chart, and type the mnemonic and the address of the information to be altered.
5. Enter data, using the space bar to skip over positions not being altered. The data in the skipped-over positions remains unchanged and prints out each time the space bar is operated.
6. To end the alter operation, press the ALTER/DISPLAY key or END key. If you press the ALTER/DISPLAY key, the PR-KB remains in alter/display mode. If you press the END key, alter/display mode is terminated.

To Stop on Main Storage Address

1. Press the STOP key (machine in manual state).
2. Set STORAGE SELECT switch to MAIN.
3. Set ADDRESS COMPARE switch to ANY.
4. Set the address of the desired storage address in console switches CDEFGH.
5. Set the ADDRESS COMPARE (SAR) toggle switch to STOP.
6. Press the START key.

To Clear Storage

1. Hold down the ENABLE SYSTEM CLEAR key.
2. Press the SYSTEM RESET or LOAD key. All of main storage including the storage protect keys will be cleared to zeros.

Hard Stop Option

The HARD STOP switch is used with operating systems that do not have the retry facilities inherent in Model 155 hardware. At this setting, the machine stops when parity/machine checks occur. After a hardstop, the operator should return CHECK CONTROL to PROCESS, run the SEREP program, and save the results for the CE.

System/370 Model 158

Source: GC38-0025 System/370 Model 158 Operating Procedures

Power-On Procedure

DANGER: Before switching on power, ensure that no person is exposed to risk and that all equipment covers are shut.

1. Insert the IMPL diskette in the console file. Carefully close cover.
2. Press the POWER ON pushbutton. This button lights red, then white upon completion of the power-on sequence. An IMPL is automatically initiated.

Power-Off Procedure

1. Preparatory to turning power off:
 - a. Unload all disk and tape drives.
 - b. Open or disengage the print release lever on all printers that use print train cartridges.
2. Press the POWER OFF pushbutton to initiate the power-off sequence. The contents of main storage are not preserved.

To IMPL

1. Press IMPL pushbutton. This causes the initial microprogram load of the display console and CPU reloadable control stores to occur. During IMPL, the message 'IMPL IN PROCESS' is displayed.
2. On completion of IMPL the configuration frame appears. The system is IMPLed in display mode. If PR-KB mode is desired, or timer options, select them on this frame.
3. Exit from the configuration frame by selecting MANUAL with the light pen or by pressing MODE SEL on the keyboard.

To IPL

1. Enter load unit address and select 4 under O-OPERATOR FUNCTIONS or key in letter O and 4, followed by letter "L" and 3-digit address.
2. Press ENTER.
3. Select X-EXECUTE OPERATOR FUNCTION or key in X. Upon completion of a successful IPL, the program frame appears.
4. Respond to system messages that appear on the screen.
5. Set time and date.

Loading a Secondary Nucleus (OS)

Follow the procedure shown for the Mod 155, using either the PR-KB or the light pen.

To Display Registers, PSW, and Main Storage

1. Press STOP key.
2. Press MODE SEL to display manual frame.
3. Select '3 ALTER/DISPLAY' under FRAME CONTROL or key in F3.
4. Select D under FUNCTION on the ALTER/DISPLAY frame, or key in D.
5. Select or key in the letter of the facility to be displayed.
6. Key in address—none necessary for general registers and PSW.
7. Press ENTER. The contents of the facility selected will be displayed in the center of the screen.

System/370 Model 158 (cont'd)

To Alter Registers, PSW, and Main Storage

1. If the system is in Alter/Display mode, press CANCEL key. This will re-initialize Alter/Display. If the system is in Program mode, (a) press STOP key; (b) press MODE SEL to display Manual frame; select '3 ALTER/DISPLAY' or key in F3.
2. Select A under FUNCTION on the ALTER/DISPLAY frame, or key in A.
3. Select or key in the letter of the facility to be altered.
4. Key in address and PSW.
5. Alter data. As the data is entered, the digit appears under the old value and the cursor is spaced forward.
6. To store altered data, select the ENTER function by use of the light pen or press ENTER key. If data to be altered is on the top line, the ENTER function must be selected prior to the New Line function, otherwise the data remains unaltered.
7. After altering data, press MODE SEL once to return to manual frame; twice to return to program frame.

To Stop on Main Storage Address

1. Press MODE SEL to display manual frame.
2. Select 1 ANY and 5 STOP under S-SAR COM SEL (REAL), or key in S1 and S5.
3. Key in E and address of main storage.
4. Press ENTER key.

To Clear Main Storage

1. Select O-6 SYS RESET CLEAR under O-OPERATOR FUNCTIONS, or key in letter O-6.
2. Press ENTER key.

Hard Stop Option

After a hardstop:

1. Return CHECK CONTROL to PROCESS.
2. Select SERVICE frame.
3. Select INDEX frame.
4. Select EXTERNAL DIAGNOSTIC frame.
5. Be sure "N" diskette is inserted in IGAR2.
6. Load "N" disk.
7. PROGRAM frame will be displayed after "N" disk load. Make entries per questions asked.
8. Save the results for the CE.

In hardstop mode, the CPU clocks are stopped by any error that causes a machine trap. If CE advises running in hard stop mode, start the clocks. This will cause the system to run as if it were in PROCESS mode.

System/370 Model 165

Source: GA22-6969 System/370 Model 165 Operating Procedures

Power-On Procedure

- Check doors, feeds, cards and/or paper.
 - Check tapes, disks, and two-channel switch, if applicable.
 - Check coolant and MG power, if applicable.
1. Press POWER ON (turns red).
 2. Wait; POWER ON turns white.
 3. If manual light does not turn on, check CONSL FILE light. If on:
 - a. Set RSDT/NONRSDT to RSDT.
 - b. Set FILE SECTION SELECT to 0.
 - c. Press LOAD MD.
 4. If manual light is on, check I/O.
 - a. 2250—Press POWER ON (backlight).
 - b. Disks—Set ENABLE and START.
 - c. 2701—Set to ENABLE.

Power-Off Procedure

1. Issue WRITELOG and HALT commands.
2. Press STOP to turn manual light on.
3. Perform two-channel switch procedure, if applicable.
4. Check tapes; press RESET and LOAD REWIND. After rewind, press UNLOAD and RESET.
5. Check disks; switch to STOP.
6. Press POWER OFF (backlight off).
7. Check coolant and MG power, if applicable.

To IPL

1. Set LOAD UNIT switches to residence volume address.
2. Hold SYSTEM CLEAR; press LOAD. Manual light goes off, LOAD light comes on, and system reads in the IPL program.
3. When LOAD light goes off, IPL is in and running.
4. Reply to system messages and set TOD clock.

Loading a Secondary Nucleus (OS)

1. Set LOAD UNIT switches to residence volume address.
2. Set RATE switch to INSN STEP.
3. Press the LOAD key.
4. Use the Alter procedure to store, in location 08 (hex), the two hex digits designating the secondary nucleus.
5. Set RATE switch to PROCESS.
6. Press START key.

To Display General Registers

1. Press STOP.
2. Set CRT MODE SELECT to CE and MANUAL ENTRY SELECT to MCDR.
3. Set STORAGE SELECT to GEN PUR.
4. Press ⇒ until cursor underscores high-order second byte.
5. Enter two hex digits (to select desired register) by pressing the data keys. Use 00 to 0F for general registers.
6. Press DISPLAY. The contents of the addressed general register are displayed on the CRT in the right half of the MCDR.
7. Restore CRT MODE SELECT to OP.
8. Press START to resume processing.

System/370 Model 165 (cont'd)

To Alter (Load into) General Registers

1. Perform steps 1-6 of "Display General Register".
2. Set MANUAL ENTRY SELECT to MCDR. Check that the ⇒ underscores desired byte.
3. Enter desired data via data keys. (If error is made, press ⇒ until wraparound, then return to desired byte and enter correct data.)
4. When the right-half of MCDR shows desired data (four bytes), press STORE. To verify, press DISPLAY.
5. To resume, set CRT MODE SELECT to OP and press START.

To Display Current PSW

1. Press STOP.
2. Set CRT MODE SELECT to CE.
3. See bits 40-63 at IC on CRT.
4. See bits 0-15 and 32-39 at image A3 on indicator viewer. (Bits 16-31 are 0's.)
5. To resume, set CRT MODE SELECT to OP and press START.

To Alter (Load) Current PSW

1. Perform steps 1-4 of "Display Current PSW".
2. Set MANUAL ENTRY SELECT to MCDR.
3. Enter desired data via data keys. (If error is made, press ⇒ until wraparound, then return to desired byte and enter correct data.)
4. When all eight bytes are in MCDR, press SET PSW. To verify, perform steps 1-4 of "Display Current PSW".
5. To resume, set CRT MODE SELECT to OP and press START.

To Display Main Storage

1. Press STOP.
2. Set CRT MODE SELECT to CE and MANUAL ENTRY SELECT to MCAR.
3. Set STORAGE SELECT to MAIN STOR.
4. Press ⇒ until cursor underscores second byte.
5. Enter six-digit hex address via data keys. (If error is made, press ⇒ until wraparound, then return to desired byte and enter correct data.)
6. When six-digit address shows at MCAR, press DISPLAY. See eight bytes of storage displayed at MCDR on the CRT.
7. To see next doubleword, press ADV ADDRESS, then press DISPLAY.
8. To resume, set CRT MODE SELECT to OP and press START.

To Alter (Store into) Main Storage

1. Perform steps 1-6 of "Display Storage".
2. Set MANUAL ENTRY SELECT to MCDR. Press ⇒ until cursor underscores desired byte.
3. Enter desired data via data keys. (If error is made, press ⇒ until wraparound, then return to desired byte and enter correct data.)
4. When MCDR shows desired data (eight bytes), press STORE. To verify, perform steps 1-7 of "Display Storage".
5. To resume, set CRT MODE SELECT to OP and press START.

To Stop on Main Storage Address (Compare Stop)

1. Press STOP. Set STORAGE SELECT to MAIN STOR.
2. Set CRT MODE SELECT to CE.
3. Set ADDRESS COMPARE/SYNC to IC.
4. Set stop on compare (MS) to STOP.
5. Set CS/MS to MS.
6. Set MANUAL ENTRY SELECT to MRAR.
7. Press ⇒ until cursor underscores second byte in MRAR.
8. Enter 6-digit hex stop address via data keys. (If error is made, press ⇒ until wraparound, then return to desired byte and enter correct data.)
9. Set CRT MODE SELECT to OP; press START.
10. To resume, set CS/MS to CS/MS, stop on compare (MS) to NORM, and press START.

System/370 Model 165 (cont'd)

To Clear Main Storage (Clear Storage)

1. Hold SYSTEM CLEAR; press SYSTEM RESET.
2. Release SYSTEM CLEAR; manual light turns on.
3. Perform IPL.

Hard Stop Option

If both wait and system lights are off, possible hardstop may be assumed. If no special procedures are provided by service personnel, follow procedures in Hardstop option, listed below.

1. Set MACHINE CHECK to STOP ON CHK.
2. At stop, press STOP, CHECK RESET, and START.

System/370 Model 168

Source: GC38-0030 System/370 Model 168 Operating Procedures

Power-On Procedure

DANGER: Before turning on the system, check all peripheral units externally. Do not mount tape reels until after power-on.

1. Press POWER ON (turns red).
2. Wait about one minute until POWER ON turns white.
3. If the manual light does not turn on after approximately two minutes, follow this procedure:
 - a. Set RSMT/NON RSMT to RSMT.
 - b. Set FILE SECTION SELECT to 0.
 - c. Press LOAD MD. The manual light should turn on within one minute.

Power-Off Procedure

Before initiating the power-off sequence, issue Writelog and Halt commands. If manual light is not on, press STOP; the manual light will come on. Perform "Two-Channel Switch procedure" if applicable.

1. Check all tape units. Place units in unload state by pressing RESET and LOAD REWIND. After rewind is completed, press UNLOAD on each tape unit. Press RESET to shut power window.
2. Check all disk drives. Place drives in unload state by switching to STOP on each disk drive that is running. (Disk drives must be individually turned off before power is turned off.)
3. Press POWER OFF. Power is sequenced down automatically. POWER ON light goes off.
4. Continue power-off procedures for peripheral equipment not connected to the power-off sequence.

To IPL

1. Set LOAD UNIT switches to SYSRES volume address.
2. Press ENABLE SYSTEM CLEAR and LOAD simultaneously. Pressing these pushbuttons starts IPL, but first clears storage. Manual light goes off, LOAD light comes on, and system reads in the IPL program.
3. When LOAD light goes off, IPL operation is successfully completed.
4. Reply to system messages and set TOD clock.

Loading a Secondary Nucleus (OS)

1. Set LOAD UNIT switches to residence volume address.
2. Set RATE switch to INSN STEP.
3. Press the LOAD key.
4. Use the Alter procedure to store, in location 08 (hex), the two hex digits designating the secondary nucleus.
5. Set RATE switch to PROCESS.
6. Press START key.

To Display General Registers

1. Press STOP. Manual light comes on.
2. Set CRT MODE SELECT to CE.
3. Set STORAGE SELECT to GEN PUR.
4. Set MANUAL ENTRY SELECT to MCR.
5. Press cursor advance key \Rightarrow until the cursor underscores the first (high-order) byte in MCR.
6. Enter two hex digits (to select desired register) by pressing the data keys. Use 00 to 0F for 16 general registers.
7. Press DISPLAY. The contents of the addressed general register are displayed on the CRT in the right half of the MCDR.
8. Restore CRT MODE SELECT to OP.
9. Press START to resume processing.

System/370 Model 168 (cont'd)

To Alter (Store in) General Registers

1. Perform steps 1 through 7 above.
2. Set MANUAL ENTRY SELECT to MCDR.
3. Make certain the cursor is underlining the first byte to be changed. Enter the data desired by pressing the data keys. In case of error, press the cursor advance key \Rightarrow until wraparound occurs, then return to the byte desired and enter the correct data.
4. Press STORE. Four bytes (right half of MCDR) are loaded into the general register selected.
5. Press DISPLAY to verify the load operation.
6. Restore CRT MODE SELECT to OP.
7. Press START to resume processing.

To Display Current PSW

1. If the manual light is not on, press STOP.
2. Set CRT MODE SELECT to CE. The PSW is displayed in portions. The last portion (bits 40-63) of the instruction address is directly displayed on the right side of the CRT, in the space designated IC. The entire first word (less the interruption code), as well as bits 32-39 (first portion of second half of current PSW) may be seen in image A3 of the indicator viewer.
3. Restore CRT MODE SELECT to OP when processing is to continue.
4. Press START to resume processing.

To Alter (Load) Current PSW

1. Press STOP. Manual light turns on.
2. Set CRT MODE SELECT to CE.
3. Set MANUAL ENTRY SELECT to MCDR.
4. Enter the PSW data by pressing the data keys; the cursor indicates what is actually entered at a specified location.
5. When all eight bytes of the MCDR are set as desired in the new current PSW, press SET PSW. Verify change by displaying current PSW. (The only portion not displayed is the interruption code, which should be zero.)
6. Restore CRT MODE SELECT to OP position.
7. Press START to resume processing.

To Display Main Storage

The CRT displays eight bytes, starting with the real location addressed.

1. Press STOP. Manual light turns on.
2. Set CRT MODE SELECT to CE.
3. Set STORAGE SELECT to MAIN STOR.
4. Set MANUAL ENTRY SELECT to MCAR to enter the real address.
5. Press the cursor advance key \Rightarrow until the cursor underscores the second byte in MCAR. (The first byte is ignored.)
6. Enter a 6-digit hex address by pressing the data keys. As each key is pressed, the appropriate digit appears in the MCER. As every second digit completes a byte, that byte appears in the MCAR and the cursor advances to the next byte.
7. Press DISPLAY. Eight bytes of storage are displayed at MCDR on the CRT display. To display the next doubleword of main storage, proceed with step 8.
8. Press ADV ADDRESS, then press DISPLAY. ("Blinking" bytes denote bad parity. Press CHECK RESET to clear pending errors.)
9. Restore CRT MODE SELECT to OP.
10. Press START to resume processing.

System/370 Model 168 (cont'd)

To Alter (Store into) Main Storage

Every store operation should be preceded by a display operation to prevent destruction of data by doubleword storing. For real addresses, use "Display Main Storage" procedure; for logical addresses, use "Translate Address and Display Main Storage" procedure shown after this procedure.

1. Perform steps 1 through 7 of "Display Main Storage" or "Translate Address and Display Main Storage."
2. Set MANUAL ENTRY SELECT to MCDR.
3. Press cursor advance key \Rightarrow until the cursor underscores the byte in MCDR where the data is to be entered.
4. Enter the data change by pressing the data keys. As soon as the byte is entered in the MCER, it is transferred to the MCDR where it can be checked for accuracy. If an error occurs, press the cursor advance key until wraparound occurs, and return to the byte desired. Enter the correct data.
5. Press STORE key.
6. Set CRT MODE SELECT to OP.
7. Press START to resume.

Translate Address and Display Main Storage

The CRT displays eight bytes, starting with the logical location addressed.

1. Press STOP. Manual light turns on.
2. Set CRT MODE SELECT to CE.
3. Set STORAGE SELECT to MAIN STOR.
4. Set MANUAL ENTRY SELECT to MCAR to enter the logical (virtual) address.
5. Press the cursor advance key \Rightarrow until the cursor underscores the second byte in MCAR. (The first byte is ignored.)
6. Enter a six-hex-digit logical address by pressing the data keys. As each key is pressed, the appropriate digit appears in the MCER. As every second digit completes a byte, that byte appears in the MCAR and the cursor advances to the next byte.
7. Press TSLT ADR & DISPLAY MAIN. The real address replaces the logical address in MCAR, and the data at the real address appears in MCDR. If zeros appear in both the MCAR and MCDR, either a translation exception associated with the specified logical address has occurred, or the resulting real address is invalid for the system.
8. Restore CRT MODE SELECT to OP.
9. Press START to resume processing.

To Stop on Main Storage Address

1. Press STOP. Manual light turns on.
2. Set STORAGE SELECT to MAIN STOR.
3. Set ADDRESS COMPARE/SYNC: to IC for a match between the IC and the logical address set in the MRAR; or to CHAN for a match between a real address set in the MRAR and a main storage address selected by a channel; or to CPU/CHAN for a match between a real address set in the MRAR and an address selected either by the CPU or by the channels; or to CPU (REAL) for a match between the address selected by the CPU and the real address set in the MRAR; or to CPU (LOGICAL) which is the same as "Real Address" except that a logical address must be entered in the MRAR.
4. Set CS/MS to MS; set stop on compare (MS) to STOP.
5. Set CRT MODE SELECT to CE.
6. Set MANUAL ENTRY SELECT to MRAR.
7. Press cursor advance key \Rightarrow until the cursor underscores the second byte in MRAR displayed on the CRT. (Using a six-byte address, ignore the first MRAR byte.)
8. Enter six-hex-digit logical address (where stop is desired) by pressing the data keys. As each key is pressed, the appropriate digit appears in the MCER. As every second digit completes a byte, that byte appears in the MRAR and the cursor advances to the next byte. If an error occurs, press the cursor advance key until wraparound occurs, and return to the byte desired, then enter the correct digits.

System/370 Model 168 (cont'd)

To Stop on Main Storage Address (cont'd.)

9. Return CRT MODE SELECT to OP.
10. Press START to resume processing.
11. When the CPU stops at the desired compare stop, reset CS/MS to CS/MS, reset stop on compare (MS) to NORM, and press START to resume processing.

To Clear Main Storage

Under normal operation, it is unnecessary to clear storage because the operating system provides this function as required.

1. Depress and hold ENABLE SYSTEM CLEAR.
2. Press SYSTEM RESET. Manual light comes on.
3. Re-IPL.

Hard Stop Option

The hardstop option is normally specified for limited operation and should be used only on recommendation of the service personnel. In this case, MACHINE CHECK is set to STOP ON CHK and is left in this position. At stop time:

1. Record all check lights that are turned on; save the information for the service personnel.
2. Re-IPL, or see appropriate operating system operator's library manual.

System/370 Model 195

Source: A22-6954 System/360 and System/370 Model 195
Operating Procedures

Power-On Procedure

DANGER: Before turning on the system, ensure that no person is exposed to risk and check all peripheral units externally. Check that doors are properly closed, feeds not impeded, and paper and card supplies suitable to permit power-on sequencing.

1. Check panel light coolant check or coolant water temperature gage for normal setting before power-on sequence.
2. Press POWER ON (operator control panel); the backlighted key should turn red immediately.
3. At the completion of normal power-on sequence (a matter of seconds), the POWER ON backlight turns white. If, after 90 seconds, POWER ON does not light, check to see whether EMERGENCY PULL has been pulled.

Power-Off Procedure

Before performing the turn-off procedures, issue WRITELOG and HALT commands (if using operating system). If manual light is not turned on, press STOP; manual light turns on. Perform "Two-Channel Switch Procedures" if applicable.

1. Check all tape units. Put them in unload state by pressing RESET and LOAD REWIND. After REWIND is completed, press UNLOAD on each tape unit and press RESET to shut power window.
2. Check all disk drives. Put them in unload state by switching to STOP on each disk drive if drives are running. (Disk drives must be individually turned off before power is turned off.)
3. Press POWER OFF. Power is sequenced down automatically. The power-on light turns off.
4. Continue power-off procedures for peripheral equipment not connected to the power-off sequence.

Manual IPL

Manual IPL is performed after a power-on sequence, after malfunctions that necessitate reloading the resident portion of the operating system (control program) into main storage, as part of switching from one operating system to another, or for initial loading of any stand-alone program.

1. Place the program on the desired I/O device and ready that device. (Check that CRT DISPLAY & TAPE OP is at process. Check that test light is off, unless a critical switch has been deliberately set to other than normal position.)
2. Set the three LOAD UNIT switches to the I/O address required.
3. If the installation does not use the secondary nucleus, go to step 4. If the secondary nucleus is used, follow procedure in "Loading the Secondary Nucleus" as direct replacement for step 4.
4. Press LOAD. The load light turns on, the manual light turns off, and system reset occurs. When the loader portion of the program is in main storage, the load light turns off and control of the system is passed to the channel, which directs the storage of the remainder of the program.
5. If this is a stand-alone program (independent utility: DASD1, DUMP/RESTORE, or RECOVER/REPLACE), and it is loaded properly, the wait light turns on. The IC reads FFCO. Type, for example, INPUT=2400 181 (where 2400 is the magnetic tape device type, and 181 is its hex address). Hold down ALTN CODE key and press numeric 5 key. When the job is completed, the program prints out END OF JOB and enters the wait state.

System/370 Model 195 (cont'd)

Loading the Secondary Nucleus (OS)

This procedure replaces step 4 of "Manual IPL" where the installation uses the secondary nucleus instead of the primary nucleus.

1. Press STOP; manual light turns on.
2. Set ADDRESS switches to location hex 80
3. Set ADDRESS COMPARE to INSN SOFT STOP.
4. Press LOAD; load light turns on, the manual light turns off, and system reset occurs. When the loader portion of the program is in main storage, the load light turns off and the manual light turns on.
5. Perform steps 1-4 of "Display Main Storage" at location hex 000008.
6. Enter the data (2 hex digits) in the appropriate CXR/CBR (data) switches. The two hex digits may range from F1 to F9. (Last hex digit determined by last character of nucleus name.)
7. Press STORE.
8. Return ADDRESS COMPARE switch to normal setting (PROCESS).
9. Press START. (The secondary nucleus has been loaded.)

System/370 Model 195 (cont'd)

To Alter/Display General Registers, Floating-Point Registers, and Main Storage

Alter/Display Chart

Position of CRT DISPLAY & TAPE OP	Position of STOR/DISPLAY/STG SELECT	Operator Action	Area Displayed/ Stored
PROC		Stop CPU	CPU regs on CRT
	GEN REGS	Set ADDRESS switches 20-23. Press SET CAR. Place CBR/CXR switch to CBR position. Press FTH into CBR (panel M). To alter, set new data in the appropriate CXR/CBR switches. Press STORE (panel M).	Gen reg specified: data in lights 0-31 of CXR/CBR. Data in switches 0-31 of CXR/CBR.
FLP REGS		Stop CPU	FLP regs on CRT
	FLP REG	Set ADDRESS switches 21-22. Press SET CAR. Press FTH into CBR. Press STORE.	FLP reg specified: data in lights 0-63 of CBR.
STORAGE	MAIN STORAGE	Set ADDRESS switches to desired storage address. Press SET CAR (panel M). Place CBR/CXR switch to CXR/CBR position. Press SCAN (panel N).	16 doublewords of main storage starting at address set in CAR will be displayed on CRT.
	MAIN STORAGE	Set ADDRESS switches to desired storage address. Press SET CAR. Place CBR/CXR switch to CBR position. Press FTH into CBR. To alter, set new data in the appropriate CXR/CBR switches. Press STORE (panel M).	Doubleword of main storage at address specified in CAR. Data in switches 0-63 of CXR/CBR.

System/370 Model 195 (cont'd)

To Display Current PSW

1. Press STOP; manual light turns on.
2. Set CRT DISPLAY & TAPE OP to PROCESS.
3. Read current PSW (bits 0-63) displayed on panel H.
4. Press START to resume processing.

To Alter Current PSW

1. Display current PSW.
2. Place CBR/CXR switch to the CBR position.
3. Set new information in the CXR/CBR (data) switches.
4. Press SET PSW. The current PSW is now altered; the now-current PSW data is automatically displayed on panel H.
5. Press START to resume instruction processing.

To Stop on Main Storage Address

1. Press STOP; manual light turns on.
2. Set ADDRESS COMPARE to (a) INSN SOFT STOP, (b) SCU STORAGE SOFT STOP, or (c) CHAN S/F SOFT STOP.
3. Set ADDRESS/ADDRESS COMPARE to the desired stop address.
4. Press START to resume processing. After the compare stop has been accomplished, restore switches to their normal settings, then press START.

To Clear Main Storage Only

Under normal operating-system operation, it is unnecessary to clear main storage because the operating system provides this function as required. For certain testing operations, however, it may be desirable to clear main storage. The following procedure clears main storage, but does not alter the contents of general or floating-point registers.

1. Press STOP; manual light turns on.
2. Set STORE/DISPLAY/STG SELECT to MAIN STORAGE.
3. Set CRT DISPLAY & TAPE OP to STORAGE.
4. Set all CXR/CBR switches to 0 or press CBR TO ZEROS.
5. Set (lever) STORAGE TEST to STO (up position) on panel L.
6. Press START STORAGE TEST on panel L.
7. Restore STORAGE TEST to normal, center position. All of main storage now contains data (zeros) in CXR/CBR switches.
8. To resume processing, re-IPL the control program.

To Clear System

1. Hold System Clear Enable switch (panel L) in the down position while depressing the System Reset switch. This will cause (1) a normal system reset, (2) all of main storage, GRS and FLRS, and Storage Protect keys to be reset to zero, and (3) the data buffers to be invalidated.
2. Hold System Clear Enable switch in the down position while depressing the Load switch. This will cause the machine to execute a normal system clear and then the normal load function.

System/370 Model 195 (cont'd)

Hardstop Option

If both wait and system lights are off, possible hardstop may be assumed. The hardstop procedure should be used only at the recommendation of the serviceman.

1. Set MACH CHECK STOP to HARD STOP and leave in this position; the test light remains on. The CPU hard stops on each machine check.
2. At stop time, record all check lights that are turned on; save information for the service personnel.
3. Perform storage error analysis.
4. If analysis shows main storage failure, perform procedure in "Storage Failure." At the completion of storage reconfiguration, notify the service personnel.
 - a. Press SYSTEM RESET.
 - b. Restore MACH CHECK STOP to center (normal) position.
 - c. Perform manual IPL of control program; continue processing.
5. If analysis shows buffer failure, perform procedure in "Buffer Failure." At the completion of buffer failure procedure, notify the service personnel.
 - a. Press CPU RESET.
 - b. Set MACH CHECK STOP to PROCESS.
 - c. Press FORCE MACH CHK.
 - d. Set MACH CHECK STOP to HARD STOP.
 - e. Press START to resume processing in hardstop option.
6. If analysis shows neither main storage nor buffer storage has failed.
 - a. Set MACH CHECK STOP to PROCESS.
 - b. Press START.
 - c. Set MACH CHECK STOP to HARDSTOP.

NOTE: See Source SRL for description of "Storage Failure" and "Buffer Failure" procedures.

Section 4 Contents

Section 4: Operator Commands	4-1
DOS/VS IPL Commands	4-1
DOS/VS Job Control and Attention Routine Commands	4-5
POWER/VS Commands	4-20
POWER/VS Central Operator Commands	4-21
POWER/VS JECL Statements	4-28
POWER/VS RJE Terminal Commands	4-33
VS1 System Commands	4-39
RES Workstation Commands	4-47
System Operator Commands for CRJE	4-50
OS/VS1 TCAM Commands	4-51
OS/VS VTAM Commands	4-57
VS1 Message Routing Codes	4-59
VS2 Message Routing Codes	4-59
Definitions of Substitutional Operands	4-60
OS/VS2 SVS Commands	4-62
OS/VS2 MVS System Commands	4-65
OS/VS2 JES2 Commands	4-81
OS/VS2 JES3 Commands	4-96
OS/VS2 TSO Commands	4-109
VM/370 Commands	4-127
CP Commands	4-128
CMS Commands	4-149
IPL Procedure for DOS/VS with the DOC	4-161
Display Operating Console - Model 115 and 125 - Commands	4-164
IPL Procedure for OS/VS1	4-167
IPL Procedure for OS/VS2 JES2	4-168
Formula for Computing Day of Year for Set Date Parameter	4-168
IPL Procedure for OS/VS2 JES3	4-169
OS/VS Display Consoles: Control Command and PFKs	4-171

DOS/VS IPL COMMANDS, RELEASE 33

Source: SY33-8571 DOS/VS Handbook, Vol. 1, Release 33

Operation	Operand	Remarks
ADD	$X'cuu'[(k)], device\ type \left[\begin{array}{l} X'ss' \\ X'ssss' \\ X'ssssss' \end{array} \right]$	<p>Add a device to the PUB table.</p> <p>X'cuu': Channel and unit number (k): Can be specified as either (S) or a decimal number from 0 to 255. (S) indicates that the device can be switched (that is, physically attached to two adjacent channels). The designated channel is the lower of the two channels. (0)-(255) indicates the priority of a device that cannot be switched, with 0 indicating the highest priority. If (k) is not given, the assumed priority is 255</p> <p>device type: actual device (See device codes list)</p> <p>X'ss' device specification (See X'ssss' ASSGN statement). If X'ssssss': absent the following values are assigned: X'C0' for 9-track tapes X'90' for 7-track tapes X'00' for nontapes. X'00', X'01', X'02' and X'03' are invalid as X'ss' for magnetic tape.</p> <p>X'ss' specifies SADxxx (Set Address) requirements for IBM 2702 lines: X'00' for SAD0 X'01' for SAD1 X'02' for SAD2 X'03' for SAD3</p> <p>X'ss' is required for MICR/OCR device types. It specifies the external interrupt bit in the old PSW, which is used by this device to indicate "read complete". The specifications are: X'01' PSW bit 31 X'02' PSW bit 30 X'04' PSW bit 29 X'08' PSW bit 28 X'10' PSW bit 27 X'20' PSW bit 26</p>

DOS/VS IPL COMMANDS

Operation	Operand	Remarks
ADD (Cont'd)		<p>The X'ss' parameter specifies whether or not the error correction feature is present on an IBM 1018 Paper Tape Punch with 2826 Control Unit. These specifications are:</p> <p>X'00' No error correction feature X'01' Error correction feature</p> <p>For the ICA of the M 115/125, X'ss' X'ssss' or X'ssssss' is used to specify the line mode setting for a Start/Stop line or a BSC line. This is not accepted on the ASSGN statement.</p> <p>If a one or two byte value is specified the specified value is right-justified and the rest of the three bytes is filled with zeros.</p> <p>Note: Optional statement; if required it must be entered before SET command</p>
CAT	UNIT= X'cuu'	<p>Assigns the system logical unit SYSCAT X'cuu': Indicates the hexadecimal channel (c) and unit (uu) number of the device that is to contain the VSAM master catalog.</p> <p>Note: Optional statement; if required the CAT command must follow the SET command and precede the DPD com'd.</p>
DEL	X'cuu'	<p>Delete a device from the PUB table. X'cuu': Channel and unit number.</p> <p>Note: Optional statement; if required it must be entered before SET command</p>
DPD	$\left[\text{TYPE} = \begin{matrix} \text{N} \\ \text{F} \end{matrix} \right], \text{UNIT} = \text{X}'\text{cuu}',$ $\text{CYL} = \text{xxx}[], \text{VOLID} = \text{xxxxxx}[]$	<p>Defines the page data set.</p> <p>TYPE=N: Indicates that the page data set need not be formatted and the extent limits have not been changed.</p> <p>If TYPE= N is specified but the page data set does not exist or the extent limits have been changed, TYPE= N is ignored and the page data set is formatted during IPL. In this case, the UNIT and CYL operands must either have been supplied during system generation, or they must be specified in the DPD command.</p>

DOS/VS IPL COMMANDS

Operation	Operand	Remarks
DPD (Cont'd)		<p>TYPE= F indicates that the page data set is to be formatted during IPL. Formatting during IPL is required if the page data set is to be extended or if it is to be reallocated.</p> <p>UNIT= X'cuu' specifies the channel and unit number of the device that is to contain the page data set. If UNIT is specified, CYL must also be specified.</p> <p>CYL= xxx: Specifies the sequential number of the cylinder, relative to zero, where the page data set is to begin. (The size of the page data set extent is calculated by the system) If CYL is specified, UNIT must also be specified.</p> <p>VOLID= xxxxxx identifies the alphanumeric volume serial no of the disk pack that contains the page data set. If this operand is omitted both during system generation and in the DPD command, the volume serial number is not checked.</p> <p>Notes: Required statement. The DPD command must be the last command entered during IPL procedures.</p> <p>The operands of the DPD command may be given in any order.</p>
SET	<p>[DATE= value1 [, CLOCK= value2] [, ZONE= $\left\{ \begin{array}{l} \text{EAST} \\ \text{WEST} \end{array} \right\} / \text{hh/mm}]$</p>	<p>value1: In one of the following formats: mm/dd/yy or dd/mm/yy, mm: month (01-12) dd: day (01-31) yy: year (00-99)</p> <p>value2: In the following format: hh/mm/ss, hh: hours (00-23) mm: minutes(00-59) ss: seconds(00-59)</p> <p>EAST: Specifies a geographical position east of Greenwich.</p>

DOS/VS IPL CONTROL COMMANDS

Operation	Operand	Remarks
SET (Cont'd)		<p>WEST: Specifies a geographical position west of Greenwich.</p> <p>hh/mm: A decimal value which indicates the difference in hours and minutes between local and Greenwich Mean Time. hh : 0-12 mm: 0-59</p> <p>Note: Required statement. If any ADD or DEL commands are required, they must precede the SET command.</p>

DOS/VS JOB CONTROL AND ATTENTION ROUTINE COMMANDS

Name	Operation	Operand	Remarks	Accepted by
	ALLOC	F1= nK [, F2= nK] [, F3= nK] [, F4= nK]	Allocates foreground program areas in the virtual address area. Value of n is an even number. The order of operands is arbitrary. At least one operand must be specified.	JCC AR
	ALLOCR	[BGR= nK] [, F1R= nK] [, F2R= nK] [, F3R= nK] [, F4R= nK]	Allocates real address area among foreground and background programs. Value of n is an even number. The order of operands is arbitrary. At least one operand must be specified.	JCC
	ALTER	XXXXXX	Alters 1 to 16 bytes of virtual storage. XXXXXX is the hex address where alteration is to start.	AR
[//]	ASSGN	<p>For any device:</p> <p> SYSxxx, { X'cuu' UA IGN /address-list SYSyyy } </p> <p>For disks:</p> <p> SYSxxx, { X'cuu' (address-list) SYSyyy DISK 2311 3330 2314 3340 } </p> <p>For diskettes:</p> <p> SYSxxx, { X'cuu' (address-list) SYSyyy DISKETTE 3540 } </p> <p>For tapes:</p> <p> SYSxxx, { X'cuu' (address-list) SYSyyy TAPE 2400T7 2400T9 3410T7 3410T9 3420T7 3420T9 } </p>	<p>For remarks see end of this statement</p> <p>{ ,TEMP ,PERM }</p> <p>{ ,TEMP ,PERM } [,VOL= volserno][, SHR]</p> <p>{ ,TEMP ,PERM }</p> <p>{ X'ss' ,ALT } { ,TEMP ,PERM } [,VOL= volserno]</p>	JCS JCC

DOS/VS JOB CONTROL AND ATTENTION ROUTINE COMMANDS

Name	Operation	Operand	Remarks	Accepted by
	ASSGN (Cont'd)	<p><u>For printers:</u></p> <pre> X'cuu' (address-list) SYSyyy PRINTER 1403 SYSxxx, 1403U 1443 3203 3211 5203 5203U </pre> <p><u>For card (read) punches:</u></p> <pre> X'cuu' (address-list) SYSyyy PUNCH 1442N1 1442N2 2520B1 2520B2 SYSxxx, 2520B3 2540P 2560 [,H1 ,H2] 2596 3525P 3525RP 5425 [,H1 ,H2] </pre> <p><u>For card readers:</u></p> <pre> X'cuu' (address-list) SYSyyy READER 1442N1 2501 2520B1 SYSxxx, 2540R 2560 [,H1 ,H2] 2596 3504 3505 3525RP 5425 [,H1 ,H2] </pre>	<p>For remarks see end of this statement</p> <p>[TEMP PERM]</p> <p>[TEMP PERM]</p> <p>[TEMP PERM]</p>	

DOS/VS JOB CONTROL AND ATTENTION ROUTINE COMMANDS

Name	Operation	Operand	Remarks	Accepted by																																																																																																														
	ASSGN (Cont'd)	<p><u>SYSxxx</u> :</p> <p><u>X'cuu'</u> :</p> <p><u>address-list</u> :</p> <p><u>UA</u> :</p> <p><u>IGN</u> :</p> <p><u>SYSyyy</u> :</p> <p><u>device-class</u> :</p> <p><u>device-type</u> :</p> <p><u>X'ss'</u> :</p>	<p>can be SYSRDR, SYSIPT, SYSIN, SYSPCH, SYSLST, SYSOUT, SYSLOG, SYSLNK, SYSREC, SYSRLB, SYSSLB, SYSCLB (JCC only,), or SYS000-SYSnnn.</p> <p>c= 0-6. uu = 00-FE (0-254) in hex</p> <p>a list of up to seven device addresses in the form: (X'cuu', ..., X'cuu')</p> <p>unassign</p> <p>unassign and ignore (invalid for SYSCLB, SYSRDR, SYSIPT, SYSIN)</p> <p>any system or programmer logical unit.</p> <p>READER, PRINTER, PUNCH, TAPE, DISK, or DISKETTE</p> <p>device code of any supported device</p> <p>density (magn. tape only)</p> <table border="1" data-bbox="539 1084 847 1654"> <thead> <tr> <th>ss</th> <th>BPI</th> <th>Parity</th> <th>Transl. feat</th> <th>Conv. feat</th> </tr> </thead> <tbody> <tr><td>10</td><td>200</td><td>odd</td><td>off</td><td>on</td></tr> <tr><td>20</td><td>200</td><td>even</td><td>off</td><td>off</td></tr> <tr><td>28</td><td>200</td><td>even</td><td>on</td><td>off</td></tr> <tr><td>30</td><td>200</td><td>odd</td><td>off</td><td>off</td></tr> <tr><td>38</td><td>200</td><td>odd</td><td>on</td><td>off</td></tr> <tr><td>50</td><td>556</td><td>odd</td><td>off</td><td>on</td></tr> <tr><td>60</td><td>556</td><td>even</td><td>off</td><td>off</td></tr> <tr><td>68</td><td>556</td><td>even</td><td>on</td><td>off</td></tr> <tr><td>70</td><td>556</td><td>odd</td><td>off</td><td>off</td></tr> <tr><td>78</td><td>556</td><td>odd</td><td>on</td><td>off</td></tr> <tr><td>90</td><td>800</td><td>odd</td><td>off</td><td>on</td></tr> <tr><td>A0</td><td>800</td><td>even</td><td>off</td><td>off</td></tr> <tr><td>A8</td><td>800</td><td>even</td><td>on</td><td>off</td></tr> <tr><td>B0</td><td>800</td><td>odd</td><td>off</td><td>off</td></tr> <tr><td>B8</td><td>800</td><td>odd</td><td>on</td><td>off</td></tr> <tr><td>C0</td><td>800</td><td>single dens.</td><td>9 tr.</td><td></td></tr> <tr><td>C0</td><td>1600</td><td>single dens.</td><td>9 tr.</td><td></td></tr> <tr><td>C0</td><td>1600</td><td>dual dens.</td><td>9 tr.</td><td></td></tr> <tr><td>C8</td><td>800</td><td>dual dens.</td><td>9 tr.</td><td></td></tr> <tr><td>D0</td><td>6250</td><td>single dens.</td><td>9 tr.</td><td></td></tr> <tr><td>D0</td><td>6250</td><td>dual dens.</td><td>9 tr.</td><td></td></tr> </tbody> </table>	ss	BPI	Parity	Transl. feat	Conv. feat	10	200	odd	off	on	20	200	even	off	off	28	200	even	on	off	30	200	odd	off	off	38	200	odd	on	off	50	556	odd	off	on	60	556	even	off	off	68	556	even	on	off	70	556	odd	off	off	78	556	odd	on	off	90	800	odd	off	on	A0	800	even	off	off	A8	800	even	on	off	B0	800	odd	off	off	B8	800	odd	on	off	C0	800	single dens.	9 tr.		C0	1600	single dens.	9 tr.		C0	1600	dual dens.	9 tr.		C8	800	dual dens.	9 tr.		D0	6250	single dens.	9 tr.		D0	6250	dual dens.	9 tr.		
ss	BPI	Parity	Transl. feat	Conv. feat																																																																																																														
10	200	odd	off	on																																																																																																														
20	200	even	off	off																																																																																																														
28	200	even	on	off																																																																																																														
30	200	odd	off	off																																																																																																														
38	200	odd	on	off																																																																																																														
50	556	odd	off	on																																																																																																														
60	556	even	off	off																																																																																																														
68	556	even	on	off																																																																																																														
70	556	odd	off	off																																																																																																														
78	556	odd	on	off																																																																																																														
90	800	odd	off	on																																																																																																														
A0	800	even	off	off																																																																																																														
A8	800	even	on	off																																																																																																														
B0	800	odd	off	off																																																																																																														
B8	800	odd	on	off																																																																																																														
C0	800	single dens.	9 tr.																																																																																																															
C0	1600	single dens.	9 tr.																																																																																																															
C0	1600	dual dens.	9 tr.																																																																																																															
C8	800	dual dens.	9 tr.																																																																																																															
D0	6250	single dens.	9 tr.																																																																																																															
D0	6250	dual dens.	9 tr.																																																																																																															

DOS/VS JOB CONTROL AND ATTENTION ROUTINE COMMANDS

Name	Operation	Operand	Remarks	Accepted by
	ASSGN (Cont'd)	<u>ALT:</u> <u>H1:</u> <u>H2:</u> <u>PERM:</u> <u>TEMP:</u> <u>VOL=volserno :</u> <u>SHR:</u>	specifies alternate tape unit. (Invalid for SYSIPT) specifies input hopper 1 for input on 2560 or 5425; is assumed if neither H1 nor H2 is specified. specifies input hopper 2 for input on 2560 or 5425; (invalid for programmers units) the assignment is permanent the assignment is temporary volume serial number of the tape or disk required. indicates the shared option for disk devices	
	BATCH	$\left. \begin{array}{l} \text{BG} \\ \text{Fn} \end{array} \right\}$ where n= 1,2,3 or 4	Start or continue processors	AR
	CANCEL	$\left. \begin{array}{l} \text{BG} \\ \text{Fn} \end{array} \right\}$ where n= 1,2,3 or 4	Cancels execution of current job in specified area	AR
	CANCEL	blank	Cancels execution of current job	JCC
[//]	CLOSE	$\left. \begin{array}{l} \text{SYSxxx} \\ \left. \begin{array}{l} \text{X'cuu' [, X'ss']} \\ \text{UA} \\ \text{IGN} \\ \text{ALT} \end{array} \right\} \end{array} \right\}$	SYSxxx : for magnetic tape SYSPCH SYSLST SYSOUT SYS000-SYSnnn for DASD (JCC only) SYSIN SYSRDR SYSIPT SYSPCH SYSLST X'cuu', X'ss', UA, IGN, ALT: Values as described in ASSGN command.	JCS JCC

DOS/VS JOB CONTROL AND ATTENTION ROUTINE COMMANDS

Name	Operation	Operand	Remarks	Accepted by
//	DATE	mm/dd/yy or dd/mm/yy	mm : month (01-12) dd : day (01-31) yy : year (00-99)	JCS
//	DLAB	'label fields 1-3' C xxxx,yyddd,yyddd, 'system code' [type]	'label fields 1-3': first three fields of Format 1 DASD file label. Is a 51-byte character string, contained within apostrophes and following by a comma. Entire 51-byte field must be contained in the first of the two statements. Field 1 is the file name (44-byte alphanumeric); field 2 is the format identifier (1-byte numeric); field 3 is the file serial number (6-byte alphanumeric) C: Any nonblank character in column 72. xxxx: Volume sequence number (4-digit num.) Must begin in column 16 of the continuation statement. Columns 1-15 are blank. yyddd, File creation date followed by file expiration date. Each is 5-digit numeric. 'system-code': Not required. When used, a 13-character string within apostrophes. type: SD, DA, ISC or ISE. If omitted, SD is assumed.	JCS
//	DLBL	filename, ['file-ID'], [date], [codes], [,DSF][,BUFSP=n] [,CAT=filename] (See Note 1)	filename : One to seven alphanumeric characters, the first of which must be alphabetic 'file-ID': One to forty-four alphanumeric characters (one to eight alphanumeric characters for the 3540 diskette) date : One to six characters(yy/ddd) codes : Two to four alphabetic characters(SD,DA,DU,ISC,ISE,VSAM) DSF : specifies that a data secured file is to be created or processed BUFSP=n: specifies, for a VSAM file to be processed, the number of bytes of virtual storage(0-999999) to be allocated as bufferspace CAT=filename : specifies filename (1 to 7 alphanumeric characters) of the DLBL statement for the catalog owing this VSAM file.	JCS

DOS/VIS JOB CONTROL AND ATTENTION ROUTINE COMMANDS

Name	Operation	Operand	Remarks	Accepted by
	DSPLY	XXXXXX	Displays 16 bytes of virtual storage	AR
	DUMP	$\left. \begin{array}{l} \text{blank} \\ S \\ \text{BG} \\ \text{Fn} \\ \text{BGS} \\ \text{FnS} \\ \text{PDAREA} \\ (\text{address, address}) \\ \text{where } n=1,2,3 \text{ or } 4 \end{array} \right\} \left\{ \begin{array}{l} \text{BG} \\ \text{Fn} \end{array} \right\}$	<p>Dumps specified areas of virtual storage</p> <p>Parameter causes dump on the SYSLST assigned to the specified partition. Default is BG SYSLST.</p> <p>blank: General registers plus all real and virtual partitions currently occupied by programs</p> <p>S: General registers, all real and virtual partitions currently occupied by programs, and supervisor area</p> <p>BG, Fn: applicable real or virtual partition currently occupied by progr. and associated registers</p> <p>BGS, FnS: Applicable real or virtual partition currently occupied, registers and supervisor area</p> <p>PDAREA: PD table, PD area and AAA</p> <p>address, address: Specified storage area between the two hexadecimal addresses and associated registers</p>	AR
	DVCDN	X'cuu'	X'cuu': c= 0-6 uu= 00-FE(0-254) in hex	JCC
	DVCUP	X'cuu'	X'cuu': c= 0-6 uu= 00-FE(0-254) in hex	JCC
	END or ENTER	blank	End of SYSLOG communications END for the 3210 and 3215 printer keyboards ENTER for DOC	JCC AR
	ENDSD	blank	Terminates execution of SD aids program	AR

DOS/VS JOB CONTROL AND ATTENTION ROUTINE COMMANDS

Name	Operation	Operand	Remarks	Accepted by
[//]	EXEC	{ [[[PGM=] progname] [,REAL] [,SIZE=size]] PROC= procname [,OV]	<p>PGM= progname : one to eight alphanumeric characters. Used only if the program is in the core image library</p> <p>REAL: The respective program is to be executed in real mode</p> <p>SIZE=size: can be nK, AUTO, or (AUTO,nK) nK : size of area required AUTO : take program size (AUTO,nK) : take program size plus nK</p> <p>PROC=procname : Name of cataloged procedure to be retrieved. One to eight alphanumeric characters, the first of which must be alphabetic.</p> <p>OV: Indicates that overwrite statements follow EXEC statement</p>	JCC JCS
//	EXTENT	[symbolic unit], [serial number], [type], [sequence number], [relative track], [number of tracks], [split cylinder track], [B=bins]	<p>symbolic unit : Six alphanumeric characters</p> <p>serial number : One to six alphanumeric characters</p> <p>type : One numeric character</p> <p>sequence number : One to three numeric characters</p> <p>relative track : One to five numeric characters</p> <p>number of tracks: One to five numeric characters</p> <p>split cylinder track : One or two numeric characters</p> <p>bins : One or two numeric characters</p>	JCS
	HOLD	[F1] [F2] [F3] [F4]	Causes the assignments for the specified foreground partition(s) to remain in affect until the end of the next job	JCC
	IGNORE	blank	Ignore abnormal condition	AR JCC

DOS/V S JOB CONTROL AND ATTENTION ROUTINE COMMANDS

Name	Operation	Operand	Remarks	Accepted by
//	JOB	jobname [accounting information]	jobname: One to eight alphanumeric characters accounting information: One to sixteen characters	JCS
//	LBLTYI	{ TAPE [(nn)] NSD (nn) }	TAPE: Used when tape files requiring label information, are to be processed and no non-sequential disk files are to be processed (nn): Optional and is present only for future expansion (ignored by job control) NSD: Nonsequential disk files are to be processed (nn): Largest number of extents per single file	JCS
	LFCB	X'cuu', phasename [, FORMS=xxxx] [, LPI=n][, NULMSG]	Causes the FCB of printer X'cuu' to be loaded	AR
[//]	LISTIO	{ SYS PROG Fn ALL SYSxxx UNITS DOWN UA X'cuu' }	Causes listing of I/O assignments on SYSLST for JCS and SYSLOG for JCC (n= 1,2,3 or 4)	JCS JCC
	LOG	blank	Causes logging of job control statements on SYSLOG	JCC AR
	LUCB	X'cuu', phasename [, FOLD][, NOCHK] [, TRAIN=x.xxxxx] [, NULMSG]	Causes the UCB of printer X'cuu' to be loaded	AR
	MAP	blank	Causes a map of area in real and virtual storage to appear on SYSLOG	JCC AR
	MODE	{ IR CR CE, cuu [, I [, xx,y] [, D [, xx,y] [, N R STATUS HIR ECC [, { M } { [, { R } { C } } [, { Q } { TH }] [, E= eeee] [, T= tttt] }		AR

OS/VS JOB CONTROL AND ATTENTION ROUTINE COMMANDS

Name	Operation	Operand	Remarks	Accepted by
	MODE (Cont'd)		Changes the mode of operation, changes the EFL threshold values and gives status information. Note: When HIR or ECC is specified, at least one of the optional operands within these braces must be selected. TH is only valid for the Model 145 when ECC, C is specified with the MODE command	
	MSG	{Fn} where n = 1, 2, 3 or 4	Transfers control to message routine	AR
// I	MTC	opcode, {SYSxxx} {X'cuu' [,nn]}	opcode: BSF, BSR, DSE, ERG, FSF, FSR, REW, RUN, or WTM SYSxxx: Any logical unit X'cuu': (only valid for JCC) c=0-6 uu=00-FE (in hex) nn: dec. number (01-99)	JCS JCC
	NEWVOL	[BG Fn]	Indicates that a new volume has been mounted for the specified partition	AR
	NOLOG	blank	Suppresses logging of job control statements on SYSLOG	JCC AR
//	OPTION	option 1 [,option 2, ...]	option : can be any of the following: LOG: Log control statements on SYSLSST NOLOG: Suppress LOG option DUMP: Dump registers and temporary real or virtual partition on SYSLSST in case of abnormal program end NODUMP: Suppress DUMP option LINK: Write output of language translator on SYSLNK for linkage editing. NOLINK: Suppress LINK option DECK: Output object module on SYSPCH NODECK : Suppress DECK option EDECK: Punch source macro definitions on SYSPCH	JCS

DOS/V5 JOB CONTROL AND ATTENTION ROUTINE COMMANDS

Name	Operation	Operand	Remarks	Accepted by
	OPTION (Cont'd)		<p>NOEDECk Suppress EDECk option</p> <p>ALIGN Align constants and data areas on boundaries</p> <p>NOALIGN Suppress ALIGN option</p> <p>LIST Output listing of source module on SYSLST</p> <p>NOLIST Suppress LIST option</p> <p>LISTX Output listing of object module on SYSLST</p> <p>NOLISTX Suppress LISTX option</p> <p>SYM Punch symbol deck on SYSPCH</p> <p>NOSYM Suppress SYM option</p> <p>XREF Output symbolic crossreference list on SYSLST</p> <p>NOXREF Suppress XREF option</p> <p>ERRS Output listing of all errors in source program on SYSLST</p> <p>NOERRS Suppress ERRS option</p> <p>ACANCEL Cancel job if attempt to assign device is unsuccessful</p> <p>NOACANCEL Await operator action if a device cannot be assigned</p> <p>CATAL Catalog program or phase in core image library after completion of linkage editor run</p> <p>STDLABEL Causes all DASD or tape labels to be written on the standard label track.</p> <p>SUBLIB=DF Sub-library change from A/E to D/F</p>	

DOS/V5 JOB CONTROL AND ATTENTION ROUTINE COMMANDS

Name	Operation	Operand	Remarks	Accepted by
	OPTION (Cont'd)		USRLABEL Causes all DASD or tape labels to be written on the user label track PARSTD Causes all DASD or tape labels to be written on the partition standard label track 48C 48-character set 60C 60-character set SYSPARM= Specifies a value for assembler system variable symbol and SYSPARM	
[//]	OVEND	[comments]	Indicates end of overwrite statements for a cataloged procedure	JCS JCC
[//]	PAUSE	[comments]	Causes pause immediately after processing this statement. PAUSE statement is always printed on SYSLOG. If no 3210, 3215 or DOC is available the statement is ignored.	JCS JCC
	PAUSE	$\left\{ \begin{array}{l} \text{BG} \\ \text{Fn} \end{array} \right\} [, \text{EOJ}]$ where n = 1, 2, 3 or 4	Causes pause at end of current job step or at end of job	AR
	PRTY	[P1, P2[, P3[, P4[, P5]]]]	Pn = BG, F1, F2, F3 or F4. Allows the operator to display or change the priority of partitions	AR
[//]	RESET	$\left\{ \begin{array}{l} \text{SYS} \\ \text{PROG} \\ \text{ALL} \\ \text{SYSxxx} \end{array} \right\}$	Resets I/O device assignments	JCS JCC
	ROD	blank	Causes all SDR counters for all non-teleprocessing devices on the recorder file on SYSREC to be updated from the SDR counters in main storage	JCC
//	RSTRT	SY5xxx, nnnn[, file-name]	SY5xxx: Symbolic unit name of the device on which the checkpoint records are stored. Can be SY5000-SY5nnn nnn: four character identification of the checkpoint record to be used for restart filename: symbolic name of the DASD file to be used for restarting	JCS
	SET	[UPS1=value1] [, LINECT=value2] [, RCLST=value3] [, RCPCH=value4] [, RF=value5] [, DATE=value6] [, HC=value7]	value1: 0, 1 or X value2: standard number of lines for output on each page of SYSLST value3: decimal number indicating minimum number of SYSLST disk records remaining to be written before operator warning	JCC

DOS/VS JOB CONTROL AND ATTENTION ROUTINE COMMANDS

Name	Operation	Operand	Remarks	Accepted by
	SET (Cont'd)	[,SVA=value 8] [,SPL=value 9]	<p>value 4: decimal number indicating minimum number of SYSPCH disk records remaining to be written before operator warning</p> <p>value 5: defines to the system the status of the recorder file (IJSYSREC) on SYSREC used by the RMSR feature</p> <p>RF= $\begin{cases} \text{YES} & \text{-file exists} \\ \text{CREATE} & \text{-create file} \end{cases}$</p> <p>value 6: in one of the following formats: mm/dd/yy or dd/mm/yy mm : month (01-12) dd : day (01-31) yy : year (00-99)</p> <p>value 7: HC= $\begin{cases} \text{YES} \\ \text{NO} \\ \text{CREATE} \end{cases}$</p> <p>YES: hard-copy file exists NO: No recording performed CREATE: Create a hard-copy file</p> <p>value 8: storage size in the format nK, nK for SVA and GETVIS area, respectively</p> <p>value 9: specify CREATE to have the system directory list (SDL) built in the SVA.</p>	
	START	$\begin{Bmatrix} \text{BG} \\ \text{Fn} \end{Bmatrix}$ where n=1,2,3 or 4	Same as BATCH	AR
	STOP	blank	Stops batched-job progr. processing	JCC
//	TLBL	filename, ['file-ID'], [date], [file serial number], [volume sequence number], [file sequence number], [generation number], [version number]	<p>filename : One to seven alphanumeric characters, the first of which must be alphabetic</p> <p>'file-ID': One to seventeen alphanumeric characters</p> <p>date: One to six characters (yy/ddd or d-dddd)</p>	JCS

DOS/VS JOB CONTROL AND ATTENTION ROUTINE COMMANDS

Name	Operation	Operand	Remarks	Accepted by
	TLBL (Cont'd)	Note : For ASCII file processing the fourth and fifth operands are called set identifier and file section number, respectively	{ [File serial number (EBCDIC): One to six alphanumeric characters] [set identifier (ASCII) : Six alphanumeric characters] [volume sequence number (EBCDIC)] [file section number (ASCII)] } One to four numeric characters file sequence number : One to four numeric characters generation number : One to four numeric characters version number : One to two numeric characters	
	TPBAL	[n]	n= number of partitions in which processing can be delayed(0,1,2,..., number of partitions minus one). Allows the operator to display or alter the status of the Tele-processing Balancing function.	AR
//	TPLAB	'label fields 3-10'	'label fields 3-10' : Indicated fields of the standard tape file label for either EBCDIC or ASCII. A 49-byte character string, contained within apostrophes	JCS
//	TPLAB	'label fields 3-10 C label fields 11-13'	'label fields 3-10' : same as above C : Any nonblanc character in column 72 label fields 11-13' : 20 character direct continuation of the same character string begun with fields 3-10 (no blanks, apostrophes or commas separating)	JCS
	UCS	SYSxxx, phasename [,FOLD] [,BLOCK] [,NULMSG]	Causes the 240-character universal character set contained in the core image library phase specified by phasename to be loaded as buffer storage in the IBM 2821 CU. SYSxxx must be assigned to a 1403 or 5203 Printer with the UCS feature.	JCC
	UNBATCH	blank	Terminates foreground processing	JCC
//	UPSI	nnnnnnnn	n : 0, 1 or X	JCS
//	VOL	SYSxxx, filename	SYSxxx: Can be SYS000-SYSnnn filename: One to seven alphanumeric characters, the first of which must be alphabetic	JCS

DOS/V5 JOB CONTROL AND ATTENTION ROUTINE COMMANDS

Name	Operation	Operand	Remarks	Accepted by
//	XTENT	type, sequence, lower, upper, 'serial no.', SYSxxx [,B2]	<p>type: 1 for data area (no split cylinder) 2 for overflow area (for indexed sequential file) 4 for index area (for indexed sequential file) 128 for data area (split cylinder)</p> <p>sequence: sequence number of extent within multiextent file. Can be 0-255</p> <p>lower: Lower limit of extent in the form $B_1C_1C_2C_2H_1H_2H_2$ where: $B_1 = 0$ for 2311 or 2314/2319; 0-9 for 2321 $C_1C_1 = 00$ for 2311 or 2314/2319; 00-19 for 2321 $C_2C_2C_2 = 000-199$ for 2321 or 2314/2319; 000-009 for 2321 $H_1 = 0$ for 2311 or 2314/2319; 0-4 for 2321 $H_2H_2 = 00-09$ for 2311; 00-19 for 2321 or 2314/2319 Note that the last four strips of subcell 19 are reserved for alternate track for 2321</p> <p>upper: Upper limit of extent in the same form as for lower limit.</p> <p>'serial no.': 6-alphanumeric-character volume serial number contained within apostrophes</p> <p>SYSxxx: Can be SYS000-SYSnnn B2 : 0 for 2311 or 2314/2319; 0-9 for 2321</p>	JCS

DOS/VS JOB CONTROL AND ATTENTION ROUTINE COMMANDS

Name	Operation	Operand	Remarks	Accepted by
//	ZONE	{ EAST } { WEST } /hh/mm	EAST: A geographical position east of Greenwich WEST: A geographical position west of Greenwich hh/mm: A decimal value which indicates difference in hours and minutes between local time and Greenwich Mean Time. hh may be in the range 0-12; mm in the range 0-59	JCS
/+	ignored	[comments]	Indicates end of procedure	JCS
/*	ignored	ignored	Columns 1 and 2 are the only columns checked	JCS
/&	ignored	[comments]	Columns 1 and 2 are the only columns checked. Comments appear on SYSLOG and SYSLST at EOJ	
*		comments	Column 2 must be blank	

Note 1: If the DLBL and EXTENT statements for a private core image library are in the input stream (that is, the information is not contained on the label cylinder), they must precede the ASSGN SYSCLB command.

POWER/VIS OPERATOR COMMANDS

Source: SY33-8572 DOS/VIS Handbook, Vol. 2, Release 33
GX33-9004 DOS/VIS POWER/VIS Reference Summary

POWER/VIS OPERATOR COMMAND LANGUAGE (POCL)

POWER/VIS operator commands include:

TASK MANAGEMENT COMMANDS. Used to control read/write tasks and execution processors.

QUEUE MANAGEMENT COMMANDS. Used to control the various input/output queues.

MISCELLANEOUS COMMANDS. Enable the operator, for example, to align printer forms or save the POWER/VIS account file.

The operator commands consist of two fields, the operation field and the operand field. The operand field contains one or more parameters, separated by commas, or no parameters at all. The operator commands can be entered in lowercase or uppercase.

POWER/VIS supports abbreviated as well as extended operation codes.

All command options (parameters) are valid for both formats.

The following table shows the abbreviated and the extended command codes:

Type	Extended format	Abbrev. format	Function
Task management	PSTART	S	start a task or partition
	PSTOP	P	stop a task or partition
	PGO	G	activate a task or partition
	PEND*		end POWER/VIS execution
	PCANCEL	C	cancel a POWER/VIS status report
	PFLUSH	F	flush an active job entry
PRESTART	T	restart a write task	
Queue management	PDISPLAY	D	display a job status
	PALTER	A	alter attributes
	PDELETE	L	delete a job entry or message
	PRELEASE	R	release a job entry
Miscellaneous	PBRDCST	B	transmit a message
	PINQUIRE	I	check terminal status
	PACCOUNT	J	process account file
	PSETUP		print page layout

*(E), the one-character operation code for PEND, is not supported. since the operator might inadvertently end the execution of POWER/VIS.

POWER/VS CENTRAL OPERATOR COMMANDS

{PACCOUNT} **{J}** **[tapeaddr [,filename]]**
DISK,filename
DEL

Saves the accumulated account file records. If no operand, the account file is spooled to the punch queue with priority 1 output class P and with disposition equals HOLD.

tapeaddr = write the account file to a tape unit. Format is:

cuu
X'cuu'
(cuu,X'ss')
(X'cuu',X'ss')
(X'cuu',ss)
(cuu,ss)

DISK = write the account file to disk

filename = 1 - 7 alphameric characters

DEL = delete the account file

{PALTER} **{A}** **queue, {jobname [,jobnumber]}**
ALL
***abc**
class1

[,PRI=priority]
[,DISP=disposition]

[,CLASS=class2]
[,COPY=number-of-copies]
[,REMOTE=remid]

Changes the attribute parameters of a queue entry.

jobname = 2 - 8 alphameric characters including “/,-”

jobnumber = 1 - 5 digits

ALL = alter all queue entries

POWER/VIS CENTRAL OPERATOR COMMANDS

PALTER (contd.)

*abc = any combination of 1 through 7 alphanumeric characters including “/.-”

class1 = A through Z, or 0 through 4

priority = 0 through 9 (9 is highest)

disposition = H : hold

K : keep after processing

L : leave in queue

D : delete after processing

class2 = A through Z, or 0 through 4

number-of-copies = 0 through 99

remid = 0 through 200; 0 = central operator

{PBRDCST } remid,'text'
{B }

Transmits a message from the central operator to the remote user

remid = 0 through 200 or ALLUSERS; 0 = central operator

text = 1 through 59 (49 for SNA users) characters (within single quotes)

{PCANCEL } [STATUS]
{C }

Terminates printing initiated by a PDISPLAY command.

POWER/VS CENTRAL OPERATOR COMMANDS

{ PDISPLAY } { D }	queue,jobname [,jobnumber]
	queue [,ALL]
	queue,HOLD
	queue,FREE
	queue,RJE [,remid]
	queue,LOCAL
	queue,*abc
	queue,class
	ALL [,listaddr]
	HOLD
	FREE
	RJE [,remid]
	LOCAL
	*abc
	MSG
	A
M	
Q	
T	

Displays the status in a queue of a job,

all entries of a specific job,

all non-dispatchable entries,

all dispatchable entries,

all RJE-type entries relating to both BSC and SNA type terminals,

all entries submitted by or routed to the central location,

all jobs beginning with the same letters abc,

all entries with a specified class.

Displays the status of:

all entries in all queues,

all non-dispatchable entries in the system,

all dispatchable entries in the system,

all RJE-type entries in the system relating to both BSC and SNA type terminals,

all entries in the system submitted by or routed to the central location,

POWER/VS CENTRAL OPERATOR COMMANDS

PDISPLAY (contd.)

all jobs in the system beginning with the same letters abc,
 all ALLUSERS-type messages,
 all active reader/writer tasks,
 all system messages,
 number of free queue records.
 the time, date, the number of storage pages fixed, and
 the number of tasks.

queue = LST, PUN, or RDR

jobname = 2 - 8 alphameric characters

jobnumber = 1 - 5 digits

remid = 0 through 200; 0 = central operator

*abc = any combination of 1 through 7 alphameric characters
 including “/.-”

class = A through Z, or 0 through 4

listaddr = cuu or X'cuu'

{PDELETE} {L	}	{ <table border="0" style="display: inline-table; vertical-align: middle;"> <tr> <td style="padding-right: 10px;">queue,</td> <td style="padding-right: 10px;">{</td> <td style="padding-right: 10px;">jobname</td> <td style="padding-right: 10px;">[</td> <td style="padding-right: 10px;">,jobnumber</td> <td style="padding-right: 10px;">]</td> </tr> <tr> <td></td> <td></td> <td>ALL</td> <td></td> <td></td> <td></td> </tr> <tr> <td></td> <td></td> <td>class</td> <td></td> <td></td> <td></td> </tr> <tr> <td></td> <td></td> <td>*abc</td> <td></td> <td></td> <td></td> </tr> </table>	queue,	{	jobname	[,jobnumber]			ALL						class						*abc			
			queue,	{	jobname	[,jobnumber]																		
		ALL																								
		class																								
		*abc																								
MSG [n]																										

Delete job(s) and ALLUSERS messages from the queue.

jobname = 2 - 8 alphameric characters including “/.-”

jobnumber = 1 - 5 digits

ALL = delete all queue entries

class = A through Z, or 0 through 4

*abc = any combination of 1 through 7 alphameric characters
 including “/.-”

n = delete ALLUSERS-type messages numbered n.

If omitted, all ALLUSERS-type messages are deleted.

PEND [uraddr
 KILL [,uraddr]

Terminates POWER/VS

uraddr = cuu or X'cuu'

POWER/VS CENTRAL OPERATOR COMMANDS

$\left. \begin{array}{l} \{ \text{PFLUSH} \} \\ \{ \text{F} \} \end{array} \right\} \left\{ \begin{array}{l} \text{uraddr } [, \text{HOLD}] \\ \text{partition } [, \text{HOLD}] \end{array} \right\}$

Flushes an active job or partition and, if specified, puts it in the hold state.

uraddr = cuu or X'cuu'

partition = BG, F4, F3, F2, or F1

$\left. \begin{array}{l} \{ \text{PGO} \} \\ \{ \text{G} \} \end{array} \right\} \text{uraddr}$

Activates a task

uraddr = cuu or X'cuu'

$\left. \begin{array}{l} \{ \text{PINQUIRE} \} \\ \{ \text{I} \} \end{array} \right\} \left\{ \begin{array}{l} \text{lineaddr} \\ \text{luname} \\ \text{ALL} \end{array} \right\}$

Provides status information for TP line(s) and/or SNA logical units.

lineaddr = cuu or X'cuu'

luname = name of an SNA logical unit

$\left. \begin{array}{l} \{ \text{RELEASE} \} \\ \{ \text{R} \} \end{array} \right\} \left\{ \begin{array}{l} \text{queue, jobname } [, \text{jobnumber}] \\ \text{queue, ALL} \\ \\ \text{queue, class} \\ \text{queue, *abc} \end{array} \right\}$

Releases jobs from the specified queue and makes them dispatchable:

queue = LST, PUN, or RDR

jobname = 2 - 8 alphameric characters including "/.-"

jobnumber = 1 - 5 digits

class = A through Z, or 0 through 4

*abc = any combination of 1 through 7 alphameric characters including "/.-"

POWER/VS CENTRAL OPERATOR COMMANDS

{PRESTART} uraddr [,n]
{T}

Restarts a list writer task.

uraddr = cuu or X'cuu'

n = 0 - 9999 (with or without plus or minus sign)

{PSETUP} uraddr [,n]
{U}

Prints the page layout.

uraddr = cuu or X'cuu'

n = 1 or 2 digits

{PSTART} task,uraddr [,class][,bufno]
{S} task,uraddr,tapeaddr
partition [,class][,outputclass][,MT]
RJE,lineaddr [,password]
RJE,SNA
RDR,uraddr [,class],uraddr [,bufno]
RDR,uraddr [,class][file-id][,1
[file-id][no.-of-diskettes][,SLV]

Starts a task, or a partition, or RJE line.

bufno = 1 or 2

class = A through Z, or 0 through 4

file-id = HDR1 label

lineaddr = cuu or X'cuu'

MT = multitasking partition

no.-of-diskettes = 1 - 255

outputclass = A - Z

partition = BG, F4, F3, F2, or F1

password = up to 8 alphanumeric characters

S = volume sequence checking

tapeaddr = X'cuu' (only for LST or PUN tasks)

task = RDR, LST, or PUN

uraddr = cuu or X'cuu'

V = file verification

POWER/VS CENTRAL OPERATOR COMMANDS

{PSTOP} {P}	}	{	uraddr	[,EOJ]
				,RESTART	
			partition		
			lineaddr	[,EOJ]	
			RJE,SNA,luname	[,EOJ]	}

Stops a task, partition, RJE line, RJE, SNA, or an SNA terminal session.

uraddr = cuu or X'cuu'

partition = BG, F4, F3, F2, or F1

lineaddr = cuu or X'cuu'

luname = name of an SNA logical unit

POWER/VS JECL STATEMENTS

• **\$\$ CTL** $\left[\text{CLASS} = \left\{ \frac{\underline{\text{A}}}{\text{class}} \right\} \right]$

*Specifies a default input class that is assigned to all jobs whose input class was not assigned in an * \$\$ JOB statement.*

class = A through Z (partition independent) or
0 through 4 (partition dependent)

• **\$\$ DATA** name

*Specifies the name of the corresponding * \$\$ DATA statement in the source statement library book where data is to be inserted.*

name = 1 - 8 alphanumeric characters

Positional

• **\$\$ JOB** $\left[\frac{\underline{\text{AUTONAME}}}{\text{jobname}} \right], \left[\frac{\underline{\text{D}}}{\text{disposition}} \right]$
[priority], [class]

Keyword

• **\$\$ JOB** $\left[\text{JNM} = \left\{ \frac{\underline{\text{AUTONAME}}}{\text{jobname}} \right\} \right] \left[\text{,DISP} = \left\{ \frac{\underline{\text{D}}}{\text{disposition}} \right\} \right]$
[,PRI=priority] [,CLASS=class]
[,USER=user information]

Indicates the beginning of a POWER/VS job and provides handling information.

jobname = 1 - 8 alphanumeric characters including “/.-”

disposition = D : delete after processing

H : hold

K : keep after processing

L : leave in queue

priority = 0 through 9 (9 is highest)

class = A through Z (partition independent) or

0 through 4 (partition dependent)

user information = 1 - 16 bytes; may be specified in single quotes, so that blanks may be included

POWER/VS JECL STATEMENTS

Positional

* \$\$ {LST} [D] [A]
 {PRT} [disposition [class]]
 , [forms-number]
 , [1]
 [number-of-copies]
 [tape-devaddr]
 , [norbm1]
 , [linetab]

Keyword

* \$\$ {LST} [,CLASS= { A }]
 {PRT} [class]
 [,COPY= { 1 }]
 [number-of-copies]
 [,DISP= { D }]
 [disposition]
 [,FCB=phasename]
 [,FNO= { forms-number }]
 [,JSEP=sep]
 [,LST=listaddr]
 [,LTAB=linetab]
 [,PRI=priority]
 [,RBM=(norbm1,norbm2)]
 [,RBS=norbs]
 [,REMOTE=remid]
 [,TADDR=tape-devaddr]
 [,UCS=(phasename [,option])]

Provides handling information for printed output.

class = A through Z

disposition = D : delete after processing
 H : hold
 K : keep after processing
 L : leave in queue
 N : do not intercept
 R : delete after processing
 T : spool to tape

POWER/V5 JECL STATEMENTS

KEYWORD

*\$\$ LST

PRT

(contd.)

forms-number = 1 - 4 alphanumeric characters including “/.-”

linetab = 26 digits; specifies the carriage control tape format

listaddr = SYSxxx (SYSLST or any programmer logical unit) or
cuu (or X'cuu')

norbm1 = 1 - 6 digits

norbm2 = 1 - 6 digits

norbs = 1 - 6 digits

number-of-copies = 0 through 99

option = F,C,FC, or CF where

F = load the UCB with the folding operation code to
permit printing of uppercase for lowercase bit
configurations

C = prevent data checks from being generated
because of printline mismatches with the UCB

phasename = 1 - 8 characters

priority = 0 - 9, default is the job priority

remid = 0 through 200; 0 = central operator

sep = 0 through 9

tape-devaddr = cuu' (X'cuu',X'ss')
X'cuu' (cuu,ss)
(cuu,X'ss') (X'cuu',ss)

Positional

* \$\$ PUN

	[<u>D</u>		[<u>A</u>]]
		disposition			class		
,		<u>bbbb</u>					
		forms-number					
,		<u>i</u>					
		number-of-copies					
,		tape-devaddr					
,		norbm1					

POWER/V5 JECL STATEMENTS

Keyword

```
* $$ PUN [ ,CLASS= { A } ]
           [ ,COPY= { 1 } ]
           [ ,DISP= { D } ]
           [ ,FNO= { 1111 } ]
           [ ,JSEP=sep ]
           [ ,PRI=priority ]
           [ ,RBM=(norbm1,norbm2) ]
           [ ,RBS=norbs ] [ ,PUN=punaddr ]
           [ ,REMOTE=remid ]
           [ ,TADDR=tape-devaddr ]
```

Provides handling information for punched output.

class = A through Z

disposition = D : delete after processing

H : hold

I : return to input

K : keep after processing

L : leave in queue

N : do not intercept

R : delete after processing

T : spool to tape

forms-number = 1 - 4 alphanumeric characters including “/.-”

norbm1 = 1 - 6 digits

norbm2 = 1 - 6 digits

norbs = 1 - 6 digits

number-of-copies = 0 through 99

priority = 0 - 9, default is the job priority

punaddr = SYSxxx (SYSPCH or any programmer logical unit)

cuu (or X'cuu')

remid = 1 through 200; 0 = central operator

sep = 0 through 9

tape-devaddr = cuu (X'cuu',X'ss')

X'cuu' (X'cuu',ss)

(cuu,X'ss') (cuu,ss)

POWER/VS JECL STATEMENTS

Positional

* \$\$ RDR [physical-unit-number]
 , ['file-id']
 , [$\frac{1}{\text{number-of-diskettes}}$]
 , [S]

Keyword

* \$\$ RDR [DEV=physical-unit-number]
 [,FID='file-id']
 [,NOD= { $\frac{1}{\text{number-of-diskettes}}$ }]
 [,VER= { $\frac{\text{NO}}{\text{YES}}$ }]
 [,VSC= { $\frac{\text{NO}}{\text{YES}}$ }]

Inserts a diskette file into the input stream.

physical-unit-number = physical address specified as X'cuu'

file-id = 1 - 8 alphanumeric characters

number-of-diskettes = 1 - 255

S = volume sequence checking

volume sequence checking

file verification

* \$\$ SLI [sublib.] bookname

Inserts data from a sublibrary into the job stream.

sublib = A through Z, or 0 through 9, or \$, #, or @

* \$\$ /* (no operand) or * \$\$/* (no operand)

Indicates end of job step.

* \$\$ /& (no operand) or * \$\$/& (no operand)

Indicates end of job.

* \$\$ EOJ (no operand)

Indicates the end of a POWER/VS job.

POWER/VS RJE TERMINAL COMMANDS

- Notes:**
1. When entered from an SNA terminal keyboard, the POWER/VS RJE terminal commands must be identification field (* ..).
 2. Short forms of the commands may be used by BSC-RJE, but must be preceded by the identification field (* ..).

```
{* .. ALTER} queue, {jobname [,jobnumber ]  
{* .. A      }      {ALL  
                    {*abc  
                    {class1
```

```
[,PRI=priority ]  
[,DISP=disposition ]
```

```
[,CLASS=class2 ]  
[,COPY=number-of-copies ]  
[,REMOTE=remid ]
```

Changes the attribute parameters of jobs submitted by or routed to the remote user

queue = LST, PUN, or RDR

jobname = 2 - 8 alphanumeric characters including “/.-”

jobnumber = 1 - 5 digits

*abc = any combination of 1 through 7 alphanumeric characters including “/.-”

class1 = A through Z, or 0 through 4

priority = 0 - 9 (9 is highest)

disposition = H : hold

K : keep after processing

L : leave in queue

D : delete after processing

class2 = A through Z, or 0 through 4

number-of-copies = 0 through 99

remid = 0 through 200; 0 = central operator

POWER/VS RJE TERMINAL COMMANDS

```
{ * .. BRDCST } remid,'text'  
{ * .. B }
```

Transmits a message to the central operator, to another user, or to all users (ALLUSERS).

remid = 0 through 200, or ALLUSERS; 0 = central operator

text = 1 through 40 characters (49 for SNA users)

```
{ * .. DISPLAY } { queue,jobname [,jobnumber ]  
{ * .. D } { queue [,ALL ]  
queue,HOLD  
queue,FREE  
queue,*abc  
queue,class  
ALL  
HOLD  
FREE  
*abc  
MSG  
T }
```

Displays the status of jobs submitted by or routed to the remote user.

queue = LST, PUN, or RDR

jobname = 2 - 8 alphameric characters including "/.-"

jobnumber = 1 - 5 digits

*abc = any combination of 1 through 7 alphameric characters including "/.-"

class = A through Z, or 0 through 4

T = the time, date, the number of storage pages fixed, and number of tasks.

POWER/V5 RJE TERMINAL COMMANDS

$\left. \begin{array}{l} \bullet \text{ .. DELETE} \\ \bullet \text{ .. L} \end{array} \right\}$	$\left. \begin{array}{l} \text{queue,jobname [,jobnumber]} \\ \text{queue,ALL} \\ \text{queue,class} \\ \text{queue,*abc} \\ \text{MSG [,n]} \end{array} \right\}$	

Delete jobs or messages submitted by or routed to the remote user

queue = LST, PUN, or RDR

jobname = 2 - 8 alphameric characters including “/,-”

jobnumber = 1 - 5 digits

*abc = any combination of 1 through 7 alphameric characters including “/,-”

class = A through Z, or 0 through 4

$\left. \begin{array}{l} \bullet \text{ .. FLUSH} \\ \bullet \text{ .. F} \end{array} \right\}$	$\left. \begin{array}{l} \text{task} \\ \text{task,HOLD} \end{array} \right\}$

Flushes an active RJE writer task.

task = LST or PUN

$\left. \begin{array}{l} \bullet \text{ .. GO} \\ \bullet \text{ .. G} \end{array} \right\}$	task

Reactivates an RJE writer task.

task = LST or PUN

$\left. \begin{array}{l} \bullet \text{ .. INQUIRE} \\ \bullet \text{ .. I} \end{array} \right\}$	$\left. \begin{array}{l} \text{lineaddr} \\ \text{luname} \\ \text{ALL} \end{array} \right\}$	

Provides status information for one line or SNA logical units.

lineaddr = cuu or X 'cuu'

luname = name of an SNA logical unit

POWER/V5 RJE TERMINAL COMMANDS

LOGOFF APPLID (POWER) TYPE $\left[\begin{array}{l} \text{UNCOND} \\ \text{COND} \end{array} \right]$

SNA terminal users only

Terminates an SNA session by the remote user, conditionally, or unconditionally.

APPLID(POWER) Enter as such

TYPE (COND) Enter as such

TYPE (UNCOND) Enter as such

LOGON APPLID (POWER) LOGMODE(name) DATA'remid'
[.password][,user information]

SNA terminal users only

Starts an SNA session by the remote user.

APPLID (POWER) Enter as such

LOGMODE(name) = name of an entry in the VTAM logon mode table defined at VTAM generation

DATA'remid' = 1 through 200

password = up to 8 alphanumeric characters

user information = up to 16 bytes

$\left\{ \begin{array}{l} * .. \text{RELEASE} \\ * .. \text{R} \end{array} \right\} \left(\begin{array}{l} \text{queue,jobname [,jobnumber]} \\ \text{queue [,ALL]} \\ \\ \text{queue,class} \\ \text{queue,*abc} \end{array} \right)$

Releases jobs submitted by or routed to the remote user.

queue = LST, PUN, or RDR

jobname = 2 - 8 alphanumeric characters

jobnumber = 1 - 5 digits

class = A through Z, or 0 through 4

*abc = any combination of 1 through 7 alphanumeric characters

POWER/VS RJE TERMINAL COMMANDS

$\left\{ \begin{array}{l} * \text{ .. RESTART} \\ * \text{ .. T} \end{array} \right\} \left\{ \begin{array}{l} \text{task} \\ \text{task,n} \end{array} \right\}$

Restarts an RJE writer task.

task = LST or PUN

n = 0 - 9999

$\left\{ \begin{array}{l} * \text{ .. SETUP} \\ * \text{ .. U} \end{array} \right\} \left\{ \text{LST } [,n] \right\}$

Prints the page layout.

n = 1 - 2 digits

* .. SIGNOFF (no operand)

Terminates a session by the remote BSC or SNA user.

* .. SIGNON remind [,password][,user information]

(Only supported for SNA users if generated in VTAM.
The parameter fields must be preceded and followed by
a single quotation mark and kept in brackets
('remind [,password][,user information]!')

Starts a BSC session by the remote user.

remid = 1 through 200

password = up to 8 alphanumeric characters

user information = up to 16 bytes

$\left\{ \begin{array}{l} * \text{ .. START} \\ * \text{ .. S} \end{array} \right\} \left\{ \begin{array}{l} \text{task} \\ \text{task,class} \\ \text{MSG*} \end{array} \right\}$

Starts an RJE writer task or the printing of messages.

task = LST or PUN

class = A through Z

*Note: MSG parameter invalid for SNA terminals.

POWER/VS RJE TERMINAL COMMANDS

$\left\{ \begin{array}{l} * \text{ .. STOP} \\ * \text{ .. P} \end{array} \right\}$	$\left\{ \begin{array}{l} \text{task} \\ \text{task,EOJ} \\ \text{task,RESTART} \\ \text{MSG}^* \end{array} \right\}$
---	---

Stops an RJE writer task or the printing of messages.

task = LST or PUN

*Note: MSG parameter invalid for SNA terminals.

OS/VS1 SYSTEM OPERATOR COMMANDS (VS1 Release 6)

Source: GC38-0110 Operator's Library: Reference, Release 6
GC24-1634 OS/VS1 Programmer's Reference
Digest, Release 6
GA26-1634 IBM 3800 Printing Subsystem:
Operator's Guide
GC35-0014 Operator's Library: IBM 3850 Mass
Storage System (MSS) under OS/VS
GC28-6879 OS/VS1 RES Workstation User's
Guide

This section contains outlines of OS/VS1 system operator commands and RES central operator commands. For details of usage and appropriate operands, see Operator's Library: OS/VS1 Reference, GC38-0110.

Operator commands that require no modification for RES.
These commands are not valid from RES workstations.

CONTROL	SET
DEFINE	SWAP
DUMP	SWITCH
HALT	UNLOAD
LOG	VARY
MODE	WRITELOG
PAGETUNE	

Operator commands that use additional operands for RES.

CANCEL	REPLY
DISPLAY	RESET
HOLD	START
MODIFY	STARTF
MONITOR	STOP
RELEASE	STOPMN
	WRITER

Operator commands for RES.

LISTBC	ROUTE
LOGON	SEND
LOGOFF	

OS/VS1 SYSTEM OPERATOR COMMANDS

Operation	Operand
{ CANCEL } C	<pre> { [JRN=] jobname* [(.DUMP) [ALL]] [.IN [=i] [= HOLD] .OUT [=5 [= HOLD]] [DEV=] unitaddr* [procname.] identifier* } </pre> <p>* May be specified up to five times if separated by commas and enclosed in parentheses. Can be combined with any other parameter that is allowed to be specified up to five times.</p>

{ DEFINE } N	[LIST PARM: membername]
-----------------	------------------------------

{ DISPLAY } D	<pre> T A U, [TP GRAPHIC] , [ONLINE] , [cuu] , [nnn] TAPE DASD UR [OFFLINE] R [.USER = userid] [,LIST] [ALL] RT, { ALL .ACT .INACT } { [,L [,LB [,LS] } TERM { =termid } = nnn.aam [, nnn.aam, ...] { N } { [=jobless { Q } { [=SOUT [=HOLD] [,ALLQ] jobname* [,HOLD] [,ALLQ] CONSOLES [,USER = userid] P, { IN = class [IN = 'string [, string ...]' [,ALL] OUT = class [OUT = 'string [, string ...]' [,ALL] } SQA USER [,L [,userid] </pre> <p>* May be specified up to five times if separated by commas and enclosed in parentheses.</p>
------------------	---

OS/VS1 SYSTEM OPERATOR COMMANDS

Operation	Operand
DUMP	[text]
{ HALT } Z	EOD
{ HOLD } H	<pre> { ALL IN[=inclass] } [,JBN] Q [=inclass] OUT [=outclass] } jobname* [,OUT [=outclass [outclass...]]] [,USER=userid] </pre> <p>* May be specified up to five times if separated by commas and enclosed in parentheses.</p>
{ LISTBC } LB	[NOTICES] [,MAIL=userid] [MAIL]=userid [,NOTICES]
{ LOG } L	'text'
LOGOFF	userid [,SLOW]
LOGON	CENTRAL [/password] {PROC (procname)}
MODE	<pre> { STATUS RETRY, { RECORD } } MAIN, { RECORD } } CONTROL, { THRESHOLD } } </pre> <p>Note: Blanks may be used in place of the commas in this command.</p>

OS/VS1 SYSTEM OPERATOR COMMANDS

Operation	Operand
<pre>{ MODIFY F }</pre>	<pre>{ [procname.] identifier { [name.] identifier { unitaddr { ,TYPRUN= { HOLD { NOHOLD } } ,CLASS=outclass ,CLASS=jobclass ,START= { ALL { n,... } } ,STOP= (ALL { B { S { (n,...) { userid { (userid,...) } } } } ,RESTART= { ALL { n,... } } .V= { Y { N } } ,text' } { ,PAUSE= { FORMS { DATASET } } { ,JOBCLASS=jobclass } { ,OUTCLASS=s } { ,OUTCLASS=s }</pre>

<pre>{ MODIFY F }</pre>	<pre>{ [procname.] id, { [CPRES { NOCPRES }] [,TRAN { ,NOTRAN }] [,CPACT { ,NOCPACT }] { [,HFC { ,NOHFC }] [,ATT { ,UNATT }] } * { ,USER=userid }</pre> <p>*Select at least one of these options.</p>
---------------------------	--

<pre>{ MONITOR MN }</pre>	<pre>{ JOBNAME[,T] { DSNAME { SPACE { STATUS { A { SESS [,T] { MSG }</pre>
-----------------------------	--

<pre>{ MOUNT M }</pre>	<pre>unitaddr.VOL = { (NL,volserial) { (SL,volserial) { (AL,volserial) } } [,USE { STORAGE { PUBLIC { PRIVATE }</pre>
--------------------------	--

<pre>{ MSGRT MR }</pre>	<pre>{ (D=[display-operand,...] { ,MN=A! { ,K } } { REF }</pre>
---------------------------	---

OS/VS1 SYSTEM OPERATOR COMMANDS

Operation	Operand
$\left\{ \begin{array}{l} \text{PAGETUNE} \\ \text{PGT} \end{array} \right\}$	DISPLAY $\left[\begin{array}{l} \{ \{ \text{STOP} \} \{ \} \} \\ \text{[PAGEMEAS]} \\ \text{[REACT]} \\ \text{[STATUS]} \end{array} \right]$
$\left\{ \begin{array}{l} \text{PAGETUNE} \\ \text{PGT} \end{array} \right\}$	$\text{STOP} = \{ \{ \left. \begin{array}{l} \text{level} \\ \text{SYS} \end{array} \right\} \{ \} \}$ $\text{PAGEMEAS} = \left\{ \begin{array}{l} \left(\left[\begin{array}{l} \text{ALL=} \\ \text{In=} \end{array} \right] \text{frequency} [,\text{In}=\text{frequency}] \dots \right) \\ \text{frequency} \\ \text{(frequency)} \\ \text{SYS} \\ \text{(SYS)} \end{array} \right\}$ $\text{REACT} = \left\{ \begin{array}{l} \text{time} \\ \left(\text{time} [,\text{pagetran}] \right) \\ \text{(,pagetran)} \\ \text{SYS} \\ \text{(SYS)} \end{array} \right\}$
$\left\{ \begin{array}{l} \text{RELEASE} \\ \text{A} \end{array} \right\}$	$\left\{ \begin{array}{l} \left\{ \begin{array}{l} \text{ALL} \\ \text{IN [=inclass]} \\ \text{O [=inclass]} \\ \text{OUT [=outclass]} \end{array} \right\} [,\text{JBN}] \\ \text{jobname} * \left[\text{,OUT [=outclass[outclass...]]} \right] [,\text{USER}=\text{userid}] \end{array} \right\}$ * May be specified up to five times if separated by commas and enclosed in parentheses.
$\left\{ \begin{array}{l} \text{REPLY} \\ \text{R} \end{array} \right\}$	$\left\{ \begin{array}{l} \text{id} \\ \text{msgno} \end{array} \right\} [,\text{userid}] \left[\begin{array}{l} \text{,} \\ \text{,} \end{array} \right] \left[\begin{array}{l} \text{'text'} \\ \text{text} \end{array} \right]$
$\left\{ \begin{array}{l} \text{RESET} \\ \text{E} \end{array} \right\}$	$\text{jobname} * \left\{ \begin{array}{l} \text{PRTY}=\text{nn} \\ \text{CLASS}=\text{c} \end{array} \right\} [,\text{OUT}=\text{s}] [,\text{USER}=\text{userid}]$ * May be specified up to five times if separated by commas and enclosed in parentheses.
$\left\{ \begin{array}{l} \text{ROUTE} \\ \text{RO} \end{array} \right\}$	$\left\{ \begin{array}{l} \text{JBN} \text{J} = \text{jobname} \\ \text{ALL} \text{A} \end{array} \right\} \left[\begin{array}{l} \text{,} \\ \text{,} \end{array} \right] \left\{ \begin{array}{l} \text{GROUP} \\ \text{G} \end{array} \right\} = \text{(class[,class...])}$ $\left[\begin{array}{l} \text{,} \\ \text{,} \end{array} \right] \left\{ \begin{array}{l} \text{USER} \\ \text{U} \end{array} \right\} = \text{userid} \left[\begin{array}{l} \text{,} \\ \text{,} \end{array} \right] \left\{ \begin{array}{l} \text{CLASS} \\ \text{C} \end{array} \right\} = \text{class}$ $\left[\begin{array}{l} \text{,} \\ \text{,} \end{array} \right] \left\{ \begin{array}{l} \text{DEST} \\ \text{D} \end{array} \right\} = \text{userid} \left[\begin{array}{l} \text{,} \\ \text{,} \end{array} \right] \left\{ \begin{array}{l} \text{HOLD} \\ \text{H} \end{array} \right\} = \left\{ \begin{array}{l} \text{YES} \text{Y} \\ \text{NO} \text{N} \end{array} \right\}$

OS/VS1 SYSTEM OPERATOR COMMANDS

Operation	Operand
{ SEND } { SE }	'text' [,ALL ,USER=(userid [,userid ...])] [,NOW ,LOGON] [,OPERATOR=routecode] [,SAVE] messageno [,LIST ,DELETE]

{ SET } { T }	DATE=yy.ddd CLOCK=hh.mm.ss
------------------	----------------------------

{ SETPRT } { SP }	cuu[,nn] [,FORMDEF = { H / P / B }] [,NONCRIT = { H / C / B }] FD [,BURSTER = { Y / N }] [,CGS = { 1 / 2 }] [,LIST]
----------------------	---

{ START } { S }	{ procname } Pnn [,unitaddr] [,device type] [,volserial] { procname } [,identifier] [,unitaddr] [,device type] [,volserial] ,jobname ,outclass ,jobclass ,JOBCLASS=class,OUTCLASS=s ,(parm) , [MODE= [INT [,TIME=YES, [,DEBUG YES: [,BUF=nnn]]]] [INT,S]] [EXT]] [,SCRT] [,RLSE] [,ID=x] [,KEEP] ,USER=userid; ,[keyword=option,...]* * The keyword optional parameter(s) can follow the last positional parameter. May be replaced by PARM= {jobclasses [,SWA=nnnn] [,EXCPVR=NO] [,FMT=Y] } ,RESV=nn'
--------------------	--

{ STARTF } { SF }	{ name } [,identifier] [,unitaddr] [,] [,jobname] [,] [,outclass] [,] ,[keyword=option] ...
----------------------	--

OS/VS1 SYSTEM OPERATOR COMMANDS

Operation	Operand
{STOP} {P}	<pre>{ {procname.} identifier * {name.} {,USER=userid} unitaddr jobname* JOBNAME DSNAME SPACE STATUS }</pre> <p>* May be specified up to five times if separated by commas and enclosed in parentheses. Can be combined with any other parameter that is allowed to be specified up to five times.</p>
{STOPMN} {PM}	<pre>{ JOBNAME DSNAME SPACE STATUS A SESS MSG }</pre>
{SWAP} {G}	<pre>{ OFF ON unitaddr,cuu }</pre>
{SWITCH} {I}	SMF
{UNLOAD} {U}	unitaddr
{VARY} {V}	<pre>{ {unitaddr},HARDCPY {,CMDS {SYSLOG} {,NOCMDS {,OFF {,INCMDS {,STCMDS [,ROUT= {ALL {NONE {routecode[,routecode:,...]}] }</pre>
{VARY} {V}	<pre>{ {unitaddr} ,MSTCONS {(I-cuu,O-cuu)} }</pre>
{VARY} {V}	<pre>{ {unitaddr[,PATH,cuu]} {(unitaddr:unitaddr...)} {unitaddr-unitaddr} } {,ONLINE} {,OFFLINE}</pre>

OS/VS1 SYSTEM OPERATOR COMMANDS

Operation	Operand						
{ VARY } V	{ unitaddr unitaddr-unitaddr } { O-cuu (I-cuu,O-cuu) } { ,ONLINE ,OFFLINE } { ,CONSOLE } [<table border="0" style="display: inline-table; vertical-align: middle;"> <tr> <td style="vertical-align: middle;">,AUTH=</td> <td style="vertical-align: middle;">{ ALL INFO { {SYS} [,IO] [,CONS] } }</td> </tr> <tr> <td style="vertical-align: middle;">,ROUT=</td> <td style="vertical-align: middle;">{ ALL NONE { routecode [,routecode] ... } }</td> </tr> <tr> <td style="vertical-align: middle;">,ALTCONS=</td> <td style="vertical-align: middle;">{ unitaddr O-cuu (I-cuu,O-cuu) }</td> </tr> </table>]	,AUTH=	{ ALL INFO { {SYS} [,IO] [,CONS] } }	,ROUT=	{ ALL NONE { routecode [,routecode] ... } }	,ALTCONS=	{ unitaddr O-cuu (I-cuu,O-cuu) }
,AUTH=	{ ALL INFO { {SYS} [,IO] [,CONS] } }						
,ROUT=	{ ALL NONE { routecode [,routecode] ... } }						
,ALTCONS=	{ unitaddr O-cuu (I-cuu,O-cuu) }						

{ WRITELOG } W	{ s CLOSE }
-------------------	----------------

{ WRITER } WTR	unitaddr, { <table border="0" style="display: inline-table; vertical-align: middle;"> <tr> <td style="vertical-align: middle;">{ FSP } { F }</td> <td style="vertical-align: middle;">=</td> <td style="vertical-align: middle;">{ nnn DS D }</td> </tr> <tr> <td style="vertical-align: middle;">{ BSP } { B }</td> <td style="vertical-align: middle;">=</td> <td style="vertical-align: middle;">{ nnn DS D JOB J }</td> </tr> <tr> <td style="vertical-align: middle;">{ LSP } { L }</td> <td style="vertical-align: middle;">=</td> <td style="vertical-align: middle;">{ n C }</td> </tr> <tr> <td style="vertical-align: middle;">{ HOLD } { H }</td> <td></td> <td></td> </tr> <tr> <td style="vertical-align: middle;">{ REPEAT } { R }</td> <td style="vertical-align: middle;">=</td> <td style="vertical-align: middle;">{ nnn { nnn, {JOB J} } }</td> </tr> </table> } [, { JBN J } = jobname] [, { USER U } = userid]	{ FSP } { F }	=	{ nnn DS D }	{ BSP } { B }	=	{ nnn DS D JOB J }	{ LSP } { L }	=	{ n C }	{ HOLD } { H }			{ REPEAT } { R }	=	{ nnn { nnn, {JOB J} } }
{ FSP } { F }	=	{ nnn DS D }														
{ BSP } { B }	=	{ nnn DS D JOB J }														
{ LSP } { L }	=	{ n C }														
{ HOLD } { H }																
{ REPEAT } { R }	=	{ nnn { nnn, {JOB J} } }														

RES Workstation Commands, VS1 Release 6

Source: GC24-5091 OS/VS1 Programmer's Reference
Digest

Operation	Operand
{CANCEL} {C}	{ [JBN=] jobname (jobname, jobname, . . .) { [, DUMP] [, ALL] { IN [= class HOLD] { , OUT [= class HOLD] [DEV=] unitaddr (unitaddr, unitaddr, . . .)
{DISPLAY} {D}	{ ADD A T R [, LIST] jobname (jobname, jobname, . . .) [, HOLD] Q [= list] N [= list] RT, { All { ACT { [, L , LB , LS] { INACT TERM = term-id [.dev [, term-id.dev] . . .] USER { , L { = userid
{HOLD} {H}	jobname (jobname, jobname, . . .) [, OUT [= outclass [outclass . . .]] [= (outclass, outclass, . . .)]]
{LISTBC} {LB}	[NOTICES [, MAIL] [MAIL [, NOTICES]]
{LOG} {L}	'text'
LOGOFF	[SLOW]
LOGON	userid [/password] TERM (term-id) [PROC(procname)] [NOTICES [NONOTICES]] [MAIL [NO MAIL]] [UNATT]

RES WORKSTATION COMMANDS

Operation	Operand
<pre>{MODIFY} F</pre>	<pre>identifier procname.id sfname.id unitaddr , TYPRUN=HOLD NOHOLD , CLASS=classnames [, PAUSE...] , PAUSE=FORMS DATASET [, CLASS...] [, CPRES] [, HFC] [, NOCPRES] [, NOHFC] [, CPACT] [, ATT] [, NOCPACT] [, UNATT] [, TRAN] [, NOTRAN]</pre>
<pre>{MONITOR} MN</pre>	<pre>{JOBNAMES [, T]} {MSG}</pre>
<pre>{RELEASE} A</pre>	<pre>jobname (jobname, jobname, ...) [, OUT [=outclass [outclass...]]] [= (outclass, outclass, ...)]</pre>
<pre>[REPLY] R</pre>	<pre>id [,] ['text'] [b] ['text']</pre>
<pre>{RESET} E</pre>	<pre>jobname (jobname, jobname, ...) [, PRTY=priority [, OUT=outclass]] [, CLASS=class, OUT=outclass]</pre>
<pre>{ROUTE} RO</pre>	<pre>{ A ALL } [, { C CLASS } = class] { J JBN = jobname } [, { D DEST } = userid] [, { G GROUP } = (class [, class...])] [, { H HOLD } = { Y YES } { N NO }]</pre>

RES WORKSTATION COMMANDS

Operation	Operand
{ SEND } { SE }	'text' [,USER={userid (userid,userid...)}] [,{ NOW LOGON } { SAVE }] ,OPERATOR[=route-code]
SETPRT	unitaddr,LIST
{ START } { S }	procname .id [,unitaddr ,,jobname ,,outclass [,keyword =option,...]
{ STARTF } { SF }	,name [.identifier],unitaddr [,,jobname] [,,outclass] [,keyword =option,...]
{ STOP } { P }	[identifier (identifier,identifier,...)] [procname.identifier (procname) [sfname.identifier [(sfname.identifier,sfname.identifier,...)] [unitaddr (unitaddr,unitaddr,...)] Specify at least one operand, or any combination up to 5.
{ STOPMN } { PM }	{ JOBNAME } { MSG }
{ WRITER } { WTR }	unitaddr, { FSP F = { nnn } { DS D } { JOB J } BSP B = { nnn } { DS D } { JOB J } LSP L = { n } { c } HOLD H REPEAT R = { (nnn, JOB J) } { nnn } [, JBN J=jobname]

System Operator Commands for CRJE

Source: GC38-0335 OS/VS1 CRJE

Operation	Operand
BRDCST	C { nnnn, 'text' } { 'text' } { nnnn } DELETE
CENOUT	C, J=jobname, C=class
{ MODIFY } F	[procname.] identifier, { D } = (address,...) A
MSG	C { M= 'text' [, U=userid [, Q] } D=userid
SHOW	C { JOBS [,jobname] } { USERS [,userid] } { ACTIVE [,NUMBER] } BRDCST { MSGS [,userid] } { LERB [,lineaddress] } { SESS [,userid] } { SESSREL [,userid] }
{ START } S	procname.identifier,,, { FORM } { ABNO } NFMT } { NORM } NONE
{ STOP } P	[procname,] identifier
USERID	C, { A [DD] } = (userid,password) { D [ELETE] } { S [UPPRESS] } R [ESUME]

OS/VS1 TCAM OPERATOR COMMANDS, LEVEL 9
 Source: GC30-2045 OS/VS TCAM User's Guide
 TCAM, Level 9

Operation	Command	Command Format
{ DISPLAY D }	Display Active Stations	D TP,ACT,{grpname,rln } { address }
	Display if Auto Poll Used	D TP,LIST,{grpname,rln } { address }
	Display Inactive Line Entries	D TP,INACT,{grpname,rln } { address }
	Display Inactive Open Lines	D TP,LINE,INACTIVE
	Display Intercepted Stations	D TP,INTER
	Display Line Status and Message Error Record	D TP,LINE,{grpname,rln } { address }
	Display Option Field	D TP,OPTION,statname, { X C D }
	Display Primary Operator Control Terminal Name	D TP,PRITERM
	Display Queue Control Block	D TP,QUEUE,statname
	Display Relative Line Number	D TP,ADDR,statname
	Display Secondary Operator Control Terminal Names	D TP,SECTERM
Display Station Status and Message Numbers	D TP,TERM, statname	

OS/VS1 TCAM OPERATOR COMMANDS

Operation	Command	Command Format
{ HALT } Z	System Closedown	Z TP, { QUICK } { FLUSH }
	Deactivate TCAM/VTAM Link	Z TP,VTAMI ' { , { QUICK } } { FLUSH }
{ HOLD } H	Suspend Transmission	H TP=statname
{ MODIFY } F	Activate System Interval	F { procname.id } id jobname procname INTERVAL=SYSTEM
	Activate/Deactivate Auto Poll	F { procname.id } id jobname procname ,AUTOPOLL= { grpname,rln } , { ON } { address } { OFF }
	Activate/Deactivate TCAM Service Aid Routine	F { procname.id } ,DEBUG= id jobname procname { L } { D } { IEDQFE10 } { IEDQFE20 } { IEDQFE30 } { IEDQFE40 }
	Activate/Deactivate TCAM Trace	F { procname.id } ,TRACE= id jobname procname { grpname,rln } , { ON } { address } { OFF }
	Activate/Deactivate TSO	F { procname.id } id jobname procname TS= { START } { STOP }

OS/VS1 TCAM OPERATOR COMMANDS

<i>Operation</i>	<i>Command</i>	<i>Command Format</i>
{ MODIFY F (cont'd) }	Change Block Handler Set	F { procname.id id jobname procname } statname { C A D } [,aaa]
	Change Polling Delay Duration	F { procname.id id jobname procname } POLL,statname,data
	Change Primary Operation Control Station	F { procname.id id jobname procname } OPERATOR={statname } {SYSCON }
	Change System Interval	F { procname.id id jobname procname } SYSTEM,data
	Change VTAM Line Speed	F { procname.id id jobname procname } ,SPEED=grpname,rln , {H } {L }
	Exchange Device IDs	I { procname.id id jobname procname } statnamec,statname1, statname2

OS/VS1 TCAM OPERATOR COMMANDS

Operation	Command	Command Format																						
{MODIFY} {F (cont'd)	Insert Option Field Data	F { <table border="0"> <tr><td>procname.id</td><td>.OPT=</td></tr> <tr><td>id</td><td></td></tr> <tr><td>jobname</td><td></td></tr> <tr><td>procname</td><td></td></tr> </table> } statname.opfldname.data	procname.id	.OPT=	id		jobname		procname															
	procname.id	.OPT=																						
	id																							
	jobname																							
procname																								
Make Error Records	F { <table border="0"> <tr><td>procname.id</td><td>.INTENSE=</td></tr> <tr><td>id</td><td></td></tr> <tr><td>jobname</td><td></td></tr> <tr><td>procname</td><td></td></tr> </table> } { <table border="0"> <tr><td>LINE</td><td>{</td><td>grpname</td><td>,</td><td>rln</td><td>}</td></tr> <tr><td></td><td></td><td>address</td><td></td><td></td><td></td></tr> </table> } { <table border="0"> <tr><td>TERM</td><td>,</td><td>statname</td></tr> </table> } .sense {count} {15}	procname.id	.INTENSE=	id		jobname		procname		LINE	{	grpname	,	rln	}			address				TERM	,	statname
procname.id	.INTENSE=																							
id																								
jobname																								
procname																								
LINE	{	grpname	,	rln	}																			
		address																						
TERM	,	statname																						
Start/Stop TPIO Trace	I { <table border="0"> <tr><td>procname.id</td></tr> <tr><td>id</td></tr> <tr><td>jobname</td></tr> <tr><td>procname</td></tr> </table> } TTRACE= { <table border="0"> <tr><td>TOTALSYS</td></tr> <tr><td>grpname</td></tr> <tr><td>grpname,rln</td></tr> <tr><td>linename</td></tr> <tr><td>termname</td></tr> </table> } { <table border="0"> <tr><td>ON</td></tr> <tr><td>OFF</td></tr> </table> }	procname.id	id	jobname	procname	TOTALSYS	grpname	grpname,rln	linename	termname	ON	OFF												
procname.id																								
id																								
jobname																								
procname																								
TOTALSYS																								
grpname																								
grpname,rln																								
linename																								
termname																								
ON																								
OFF																								
Switch 3705 Devices	I { <table border="0"> <tr><td>procname.id</td></tr> <tr><td>id</td></tr> <tr><td>jobname</td></tr> <tr><td>procname</td></tr> </table> } SWDI:VICT=statname { <table border="0"> <tr><td>B</td></tr> <tr><td>P</td></tr> </table> }	procname.id	id	jobname	procname	B	P																	
procname.id																								
id																								
jobname																								
procname																								
B																								
P																								
{RELEASE} {A	Release Intercepted Station	A TP=statname																						
{VARY} {V	Activate General Poll	V gpstatname.ONTP { <table border="0"> <tr><td>F</td></tr> <tr><td>B</td></tr> </table> }	F	B																				
	F																							
B																								
Activate Station to Receive and Transmit	V statname.ONTP,B																							

OS/VS1 TCAM OPERATOR COMMANDS

<i>Operation</i>	<i>Command</i>	<i>Command Format</i>
{ VARY } { V } (cont'd)	Active Station to Transmit	V statname,ONTP,E
	Activate TCAM/VTAM Link	V VTAM,ONTP
	Deactivate General Poll	V gpstatname,OFFTP,{E } {B }
	Deactivate Station for Entering	V statname,OFFTP,{E } {EM }
	Deactivate Station for Receive and Transmit	V statname,OFFTP,{B } {BM }
	Start Line Transmission	V { (grpname,rln) } ,ONTP { (grpname,ALL) } { (grpname,) } address
	Stop Line Transmission	V { (grpname,rln) } ,OFFTP { (grpname,ALL) } { (grpname,) } address } {C } {I }

NOTES:

statname is the name of the station, as specified by that station's TERMINAL macro.

OS/VS1 TCAM OPERATOR COMMANDS

address is the hardware address of the line or 3705 identical to the UNIT= operand of the DD statement for the line for which this operator command is being entered.

grpname is the name of the line group, identical to the DDNAME= operand of the DCB macro instruction for the line group for which the operator command is being entered.

rln is the relative line number of the line within the line group.

id is the abbreviation for *identifier* which is the partition number. The *procname.id* operand is used when TCAM has been started. It is identical to the *procname.identifier* field of the console START command.

jobname is used when TCAM is dequeued from the input stream (for example, from a card reader). *jobname* is replaced by the name of the job to which the operation applies, and is identical to the *jobname* field of the job statement for the job being modified by an operator command.

procname can be used in VS2 systems only.

OS/VS VTAM OPERATOR COMMANDS

VTAM, LEVEL 2

Source: GX27-0034 OS/VS VTAM Reference Summary

<pre>{DISPLAY} NET, [EVERY E] ,ID= { application program name {D } [ACT A } { bsc cluster name [INACT I } { line name [NONE N } { physical unit name [] { ncp major node name } , ID= { local 3270 terminal name { logical unit name { terminal name { terminal component name { physical unit name }</pre>
<pre>{HALT} NET[,QUICK] {Z }</pre>
<pre>{MODIFY} procname, {F } DUMP, ID=ncp name[,RMPO] NETSOL=YES NO NEG POLL=number, ID=line name POLL=number, ID=line name SESSION=number, ID=line name TEST {TRACE } ,ID= { cluster name } ,TYPE={IO } {NOTRACE } { component name } {BUF } { } { ncp name } { } { terminal name } { } line name, TYPE=LINE { } VTAMBUF, TYPE=SMS TRANLIM=number, ID=terminal name SUPP= {NOSUP INFO WARN NORM SER}¹</pre>
<pre>{START} procname{,,, (parameters),...} {S } SUPP= {NOSUP INFO WARN NORM SER}¹ CONFIG=id LIST=id MAXSUBA=number NETSOL=YES NO SSCPID=n COLD WARM NODELST=vsam data set name {TRACE } ,TYPE={IO } ,ID= { cluster name } {NOTRACE } {BUF } { component name } { } { ncp name } { } { terminal name } ,TYPE=LINE, ID=line name ,TYPE=SMS, ID=VTAMBUF APBUF=(bno,bsz,bth,F²) CRPLBUF=(bno,bsz,bth,F²) IOBUF=(bno,bsz,bth) LFBUF=(bno,bsz,bth) LPBUF=(bno,bsz,bth,F²) NPBUF=(bno,bsz,bth,F²) PPBUF=(bno,bsz,bth,F²) SFBUF=(bno,bsz,bth) SPBUF=(bno,bsz,bth,F²) UECBUF=(bno,bsz,bth,F²) WPBUF=(bno,bsz,bth,F²) ¹ OS/VS1 and OS/VS2 SVS only ² F applies to OS/VS2 MVS only</pre>

OS/VS VTAM OPERATOR COMMANDS

{VARY}
{V} NET,ACT,ID= { application segment
bsc cluster name
line name[,ANS=ON|OFF]¹
local terminal set
name[,COLD|WARM]
ncp name { (U=channel unit address)
RNAME=remote
3704/3705 name }
[,COLD|WARM] }
port name
terminal name
local physical unit name[,U=channel
unit address]
logical unit name
switched SNA major node
name[,COLD|WARM]
physical unit name
local SNA major
node[,COLD|WARM] }

{ACT,} ID= { bsc cluster name
line name
local terminal set name
ncp name
terminal name } ,LOGON=
application
program
name

{ACT,} ID= { local SNA major
node name
physical unit
name
ncp major node
name
switched SNA
major node name } ,LOGON=appli-
cation program
name
[,LOGMODE=
logon mode]
[,COLD|WARM]

ID=group name,LOGON=application program name

INACT,ID=application program major node name

INACT, { I
F
R } ,² ID= { bsc cluster name
line name
local terminal set name
ncp name[,RMPO]
port name
terminal name
physical unit name[,FINAL]³
logical unit name⁴
switched SNA major node
name
local SNA major node name }

INOP,ID= { sdlc line name[,END] }
physical unit name }

ANS=ON|OFF,ID=line name¹

PATH= { USE } { GID=n,ID=switched SNA }
{ NOUSE } { major node name }
PID=n,ID=physical unit
name }

¹ Switched SDLC lines only

² F and R apply to SNA devices only

³ F does not apply

⁴ R does not apply

VS1 MESSAGE ROUTING CODES

Source: GC38-1004 OS/VS Message Library:
Routing and Descriptor Codes

System Code	Definition
1	Master console action (01F)
2	Master console information
3	Tape area (01C)
4	DASD area (009)
5	Tape library
6	DASD library
7	Unit Record Area (01D)
8	Teleprocessing equipment status
9	System Security
10	System Error Maintenance
11	Sysout device

VS2 MVS MESSAGE ROUTING CODES

Source: GC38-0229 Operator's Library: OS/VS2
MVS System Commands
VS2 Release 3.7

System Code	JESZ Codes	Definition
none	LOG	Hardcopy log
1	MAIN	Master console action
2	MAIN	Master console information
3	TAPE	Tape pool
4	TAPE	Direct access pool
5	TAPE	Tape library
6	TAPE	Disk library
7	UR	Unit record pool
8	TP	Teleprocessing control
9		System security
10	ERROR	System error/maintenance
11		Programmer information
12		Emulators
13		Reserved for customer use
14		Reserved for customer use
15		Reserved for customer use
16		Reserved for future expansion

DEFINITIONS OF SUBSTITUTIONAL OPERANDS

Source: GC38-0110 Operator's Library, OS/VS1 Reference
VS1 Release 6

These are the definitions of substitutional operands (the lowercase operands) for your use when using the section titled *Operator Command Outlines*.

c — one input (A-Z,0-9) or output (A-Z,0-9) class.

class — one to fifteen job classes (A-Z,0-9) without priorities.

cuu — the channel and unit address (cuu) of an I/O device.

device — symbolic remote device address used at RES workstation.

devicetype — a device (for example, 2540) to be used.

display-operand — any of the DISPLAY command operands that produce a status display (A, U, Q, N, CONSOLES).

frequency — the number (0-9) of task dispatchings occurring before invocation of the page measurement routine.

hh.mm.ss — hour (00-23), minute (00-59), and second (00-59).

i — a single input class.

id — a two-digit identifier that is identical to the identifier included in the system message.

identifier — a one-to-eight-character alphanumeric name that identifies a started task. For a task started to a partition, the identifier is of the form Pnn.

inclass — one to four input queue classes (A-Z,0-9).

I-cuu,O-cuu — the channel and unit addresses (cuu) of the input (I-cuu) and output (O-cuu) devices that make up a composite console.

jobclass — one to fifteen job classes (A-Z,0-9). Priority of processing is from left to right.

jobname — the name of a specific problem program that appears on the JOB statement.

keyword=option — any valid keyword/option combination that may appear on a DD statement. Acceptable keywords are:

ACB	DISP	QNAME	TERM
AFF	DSNAME	SEP	UCS
COPIES	FCB	SPACE	UNIT
DCB	HOLD	SPLIT	VOLUME
DDNAME	LABEL	SUBALLOC	
DEST	OUTLIM	SYSOUT	

level — the in-use queue position (1-9 or N) of the STOP line.

membername — the name of a member in SYS1.PARMLIB containing partition redefinitions.

DEFINITIONS OF SUBSTITUTIONAL OPERANDS

message — the number of a message in the NOTICES section.

msgno — a one- or two-character reply identification field of the message requesting the reply.

n — a one-digit decimal number.

name — an optional name assigned as the jobname of the started device.

nm — a one- or two-digit decimal number. Refer to the explanation of the command for limitations.

nnn — a one-to-three-digit decimal number. Refer to the explanation of the command for limitations.

nnnn — a one-to-four-digit decimal number.

outclass — one to eight output classes (A-Z,0-9).

O-cuu — the channel and unit address (cuu) of an output-only console.

pagetran — a number (0-255) of page transmission operations (page-ins and page-outs)

parm — information, of variable format, to be passed to a problem program.

password — an optional parameter of one to eight characters (the first character must be alphabetic).

Pnn — a partition number (P00-P15): the identifier of a task started to a partition.

procname — the name of a cataloged procedure that resides on SYS1.PROCLIB.

qclass — one to four queue classes (A-Z,0-9 for input queues, SOUT for the output queue, HOLD for the held status).

routecode — a system-to-operator message routing code. (Refer to Figure 2.)

s — a single output class (A-Z,0-9).

string — the user-defined profile attribute(s) of the system.

termid — identification number assigned to the remote terminal.

text — information of extremely variable format.

time — a real time interval in seconds (0-9).

unitaddr — the channel and unit address (cuu) of an I/O device or symbolic address of a remote device.

userid — RES user identification.

volserial — the volume serial number of a disk pack or magnetic tape.

x — the last character in a new data set name.

yy.ddd — the year (00-99) and Julian day (000-366).

OS/VS2 SVS (Rel. 1.7) OPERATOR COMMANDS

Source: GC24-5091 OS/VS Programmer's Reference Digest

Operation	Operand
{CANCEL C}	<pre> { identifier devicetype unitaddr devicename jobname [[, DUMP] [, ALL] [, IN[=i] [, OUT[=s] } </pre>
{CONTROL K}	C, D, idd[, L=cc]
{DISPLAY D}	<pre> { SQA A T U [, TP , GRAPHIC , TAPE , DASD , UR] [, OFFLINE , ONLINE] [, cuu] [, nnn] CONSOLES jobname R Q[=qclass] N[=qclass] C, K } </pre>
DUMP	COMM=(comment)
{HALT Z}	EOD
{HOLD H}	{ Q[=inclass] } jobname
{LOG L}	'text'
MODE	<pre> { STATUS RETRY[,] {RECORD} {QUIET} MAIN[,] {RECORD} {QUIET} CONTROL[,] {THRESHOLD} {QUIET} } </pre>

VS2 SVS (Rel. 1.7) OPERATOR COMMANDS

Operation	Operand
{ MODIFY } F	{ jobname, parm } { [procname.]identifier } { , CLASS=jobclass } { , CLASS=outclass } { , PAUSE= { FORMS } } { , PAUSE= { DATASET } }
{ MONITOR } MN	{ JOBNAME[S], T } { DSNAME } { SPACE } { STATUS }
{ MOUNT } M	{ unitaddr } { , VOL=(SL, serial) } { devicename } { , VOL=(AL, serial) } { , VOL=(NL, serial) } { , USE= { STORAGE } } { , USE= { PUBLIC } } { , USE= { PRIVATE } }
{ MSGRT } MR	{ D=(display-operand, ...) } { REF } { , L= { α } } { , L= { cc } } { , L= { cca } }
{ RELEASE } A	{ Q[=inclass] } { jobname }
{ REPLY } R	id, [']text[']
{ REPLY } R (used for DUMP)	{ U } { STOR=(startaddr, endaddr, ...) } { SDATA }
{ RESET } E	jobname { , PRTY=nn } { , CLASS=c } { , PRTY=nn, CLASS=c } { , OUT=s }
{ SET } T	DATE=yy.ddd[, CLOCK=hh.mm.ss]
{ START } S	procname[.identifier] [, cuu] [, volumeserial] [, pamvalue] [, jobname] [, LSQA=nn] [, keyword=option, ...] { GTF } { GTFSNP } { .identifier } [, cuu] [, volumeserial] } { [MODE= { INT } } { (INT, S) } } { [, BUF=nnn] [, TIME= { YES } } { { NO } } { [DEBUG= { YES } } } { { NO } }])
{ STOP } P	{ [procname.]identifier } { jobname }
{ STOPMN } PM	{ JOBNAME[S] } { DSNAME } { SPACE } { STATUS }

VS2 SVS (Rel. 1.7) OPERATOR COMMANDS

Operation	Operand
{ SWAP G }	{ OFF ON unitaddr, cuu }
{ SWITCH I }	SMF
{ UNLOAD U }	unitaddr
{ VARY V }	<p>{ unitaddr O-cuu (I-cuu, O-cuu) } [{ , unitaddr , O-cuu (I-cuu, O-cuu) }] ...)</p> <p>[, AUTH= { ALL INFO ([SYS],[IO],[CONS]) } , CONSOLE , ROUT= { ALL NONE (route code[, route code]...) } , ALTCONS= { unitaddr O-cuu (I-cuu, O-cuu) }]</p>
{ VARY V }	{ unitaddr (unitaddr, unitaddr...) } { , ONLINE , OFFLINE , PATH, cuu, { ONLINE OFFLINE } }
{ VARY V }	{ unitaddr (I-cuu, O-cuu) } , MSTCONS
{ VARY V }	{ unitaddr } , HARDCPY [{ , CMDS , NOCMDS , OFF , INCMDS , STCMDS }]
	[, ROUT= { ALL NONE (route code[, route code]...) }]
{ WRITELOG W }	{ s CLOSE }

OS/VS2 MVS SYSTEM COMMANDS

VS2 Release 3.7

- Source: GC38-0229 Operator's Library: OS/VS2 System
Commands, VS2 Release 3.7
- GC35-0014 Operator's Library: IBM 3800 Mass Storage
System (MSS) Under OS/VS
- GC38-0260 Operator's Library: OS/VS2 Display Consoles
- GC27-0027 Operator's Library: VTAM Network Operating
Procedures
- GC30-0246 Operator's Library: OS/VS2 TCAM
- GC28-0629 OS/VS2 System Programming Library: TSO

ASSIGN

ASSIGN	Assign primary host for MSS multi-host environment	See Source 2 MSS manual
--------	--	----------------------------

CANCEL (C)

Canceling a MOUNT command

{ CANCEL } C	{ unitaddr } { devicetype }
-----------------	--------------------------------

Canceling a job in execution

{ CANCEL } C	jobname [, DUMP]
-----------------	------------------

Canceling an external writer allocation

Canceling the writing of a SYSOUT data set by an external writer

{ CANCEL } C	identifier
-----------------	------------

OS/VS2 MVS SYSTEM COMMANDS

CANCEL (C)

Canceling a time sharing terminal session

{ CANCEL } C	U=userid[,DUMP]
-----------------	-----------------

Changing the Dump Options

{ CHNGDUMP } CD	<pre> { SET { ,NODUMP ,SDUMP { [= (option [, option] ...)] } [, Q = { YES NO }] { ,SYSABEND { [, SDATA = (option [, option] ...)] } [, PDATA = (option ...)] } [, Q = { YES NO }] { ,SYSUDUMP } [, NODUMP , ALL ,SDUMP { [= (option [, option] ...)] } [, Q = { YES NO }] { ,SYSABEND } [, ALL { ,SYSUDUMP { [, SDATA = (option [, option] ...)] } [, PDATA = (option ...)] } [, Q = { YES NO }] } </pre>
--------------------	--

OS/VS2 MVS SYSTEM COMMANDS

Stopping a Status Display

{CONTROL K}	C,D,id[,L=cc]
----------------	---------------

DISPLAY (D)

Displaying Console Configuration Information

{DISPLAY D}	{CONSOLES C}	[,L={ ^a cc cca}]
----------------	-----------------	--------------------------------

Displaying CONTROL command functions

{DISPLAY D}	C,K	[,L={ ^a cc cca}]
----------------	-----	--------------------------------

Displaying Configuration Information

{DISPLAY D}	M	[=CPU =DEV =n =STOR =HIGH =list]	[,L={ ^a cc cca}]
----------------	---	---	--------------------------------

Displaying Device Allocation

{DISPLAY D}	U,[devicetype],	[ONLINE OFFLINE],	[xxx],	[nnnn]	[,L={ ^a cc cca}]
----------------	-----------------	----------------------	--------	--------	--------------------------------

Displaying the Current System Status

{DISPLAY D}	{J JOBS A TS}	{[,LIST] [,L]}	[,L={ ^a cc cca}]
----------------	------------------------	-------------------	--------------------------------

OS/VS2 MVS SYSTEM COMMANDS

Displaying System Requests

{ DISPLAY } D	R [{ , LIST }] [, L = { a cc cca }]
------------------	---

Displaying the Local Time and Date

{ DISPLAY } D	T
------------------	---

Displaying Terminal Activity

{ DISPLAY } D	TS [, LIST] [, L = { a cc cca }]
------------------	--

DUMP

Requesting Storage Dump

DUMP	COMM=(text)
------	-------------

HALT (Z)

Stopping the System

{ HALT } Z	EOD
---------------	-----

HOLD (H) (Suspend transmission to a station) See Source 5: TCAM manual

LOG (L)

Entering Comments into the System Log

{ LOG } L	'text'
--------------	--------

OS/VS2 MVS SYSTEM COMMANDS

MODE

Recovery Management Mode Switching

MODE	$\left[\begin{array}{l} \text{STATUS} \\ \left\{ \text{DG} \right\} \left[\text{CPU} = \left\{ \frac{\text{ALL}}{\text{x}} \right\} \right] , \left[\begin{array}{l} \text{RECORD} = \left\{ \frac{=4}{=nnn} \right\} \\ \text{QUIET} = \text{ALL} \end{array} \right] \end{array} \right]$
------	--

MODIFY (F)

Modifying Job Parameters

$\left\{ \begin{array}{c} \text{MODIFY} \\ \text{F} \end{array} \right\}$	jobname, parameters
---	---------------------

Specifying the External Writer Selection Criteria

$\left\{ \begin{array}{c} \text{MODIFY} \\ \text{F} \end{array} \right\}$	$\left\{ \begin{array}{l} \text{[procname.] identifier} \\ \left. \begin{array}{l} \text{,CLASS=[classes]} \\ \text{,JOBID=[job-id]} \\ \text{,WRITER=[STDWTR} \\ \quad \text{[user-writer-name]} \\ \text{,FORMS=[forms-name]} \\ \text{,DEST=[LOCAL} \\ \quad \text{[remote-workstation-name]} \end{array} \right\} , \dots \end{array} \right\}$
---	---

Causing the External Writer to Pause

$\left\{ \begin{array}{c} \text{MODIFY} \\ \text{F} \end{array} \right\}$	$\text{[procname.] identifier, PAUSE} = \left\{ \begin{array}{l} \text{FORMS} \\ \text{DATASET} \end{array} \right\}$
---	---

Starting Time Sharing

$\left\{ \begin{array}{c} \text{MODIFY} \\ \text{F} \end{array} \right\}$	$\text{[procname.] identifier, TS=START[, member]}$
---	---

OS/VS2 MVS SYSTEM COMMANDS

Stopping Time Sharing

{MODIFY} F	[procname.]identifier,TS=STOP
---------------	-------------------------------

MONITOR (MN)

Continual Display of Data Set Status

{MONITOR} MN	{DSNAME} {SPACE} {STATUS}
-----------------	---------------------------------

Continual Display of Job Status

{MONITOR} MN	JOBNAMES[,T]
-----------------	--------------

Monitoring Terminal Users

{MONITOR} MN	SESS[,T]
-----------------	----------

MOUNT (M)

{MOUNT} M	{unitaddr},VOL=({NL},serial) [,USE={STORAGE PUBLIC PRIVATE}] {devicetype}
--------------	--

MSGRT (MR)

Routing System Status Information

{MSGRT} MR	{ (D=(operand[,operand]...)) [,L={a cc cca}] } { NONE <u>REF</u> CONT }
---------------	--

OS/VS2 MVS SYSTEM COMMANDS

Stopping Message Routing

MR	k
----	---

PURGE

PURGE	Demount all 3330V volumes from specified host
-------	---

RELEASE

RELEASE (A)	Remove station from interrupted status
-------------	--

QUIESCE

Quiescing the System

QUIESCE	
---------	--

REPLY (R)

Replying to System Information Requests

{REPLY} R	id [, { 'text' text }]
--------------	-----------------------------

RESET (E)

Changing a Job's Performance Group

{RESET} E	jobname, PERFORM=n
--------------	--------------------

OS/VS2 MVS SYSTEM COMMANDS

Communicating with other Operators

{SEND} SE }	{ 'message' } msgno	{ ,BRDCST ,OPERATOR=routecode ,CN=console }
----------------	------------------------	---

Communicating with Specified Users

{SEND} SE }	{ 'message' } msgno	,USER=(userid[,userid]...)	[,LOGON ,NOW]
----------------	------------------------	----------------------------	--------------------

Communicating with All Terminal Users

{SEND} SE }	{ 'message' } msgno	[,LOGON ,NOW]
----------------	------------------------	--------------------

Saving Messages in the Broadcast Data Set

{SEND} SE }	{ 'message' } msgno	[,USER=(userid[,userid]...)]	,SAVE , <u>ALL</u>
----------------	------------------------	---------------------------------	-----------------------

Listing the Notice Section of the Broadcast Data Set

{SEND} SE }	[msgno,] LIST
----------------	---------------

Deleting a Message from the Notice Section

{SEND} SE }	msgno,DELETE
----------------	--------------

OS/VS2 MVS SYSTEM COMMANDS

SET (T)

Resetting the Performance Specification

$\left\{ \begin{array}{c} \text{SET} \\ \text{T} \end{array} \right\}$	IPS=nn
--	--------

Changing the Local Time and Date

$\left\{ \begin{array}{c} \text{SET} \\ \text{T} \end{array} \right\}$	$\left\{ \begin{array}{l} \text{[DATE=yy.ddd] [,CLOCK=hh.mm.ss]} \\ \text{RESET} \end{array} \right\}$
--	--

START (S)

Starting a Job from the Console

$\left\{ \begin{array}{c} \text{START} \\ \text{S} \end{array} \right\}$	procname[.identifier][,keyword=option]
--	--

Starting a Writer

$\left\{ \begin{array}{c} \text{START} \\ \text{S} \end{array} \right\}$	procname[.identifier], $\left[\begin{array}{c} \text{unitaddr} \\ \text{devicetype} \end{array} \right]$ [,volumeserial],[classes] [,keyword=option[,keyword=option]...]
--	---

OS/VS2 MVS SYSTEM COMMANDS

Starting MF/1 (System Activity Measurement Facility)

$\left\{ \begin{array}{c} \text{START} \\ \text{S} \end{array} \right\}$	$\left\{ \begin{array}{c} \text{MF1} \\ \text{procname} \end{array} \right\}$ [.identifier], [devicename], [volumeserial], [parmvalue] [,keyword=option[,keyword=option]...]
--	--

The MF/1 keywords and options include:

- $\left\{ \begin{array}{c} \text{CHAN} \\ \text{NOCHAN} \end{array} \right\}$ Specifies whether or not system channel activity is to be monitored by MF/1.
- $\left\{ \begin{array}{c} \text{CPU} \\ \text{NOCPU} \end{array} \right\}$ Specifies whether or not system CPU activity is to be monitored by MF/1.
- CYCLE** Specifies the frequency at which sampling observations are made of channel and device data.
- $\left\{ \begin{array}{c} \text{DEVICE (list)} \\ \text{NODEVICE} \end{array} \right\}$ Specifies whether or not system device activity is to be monitored by MF/1. If DEVICE is specified, a device list must indicate the classes of devices that will be monitored.
- $\left\{ \begin{array}{c} \text{CHRDR} \\ \text{NOCHRDR} \end{array} \right\}$ A device list choice of character reader devices.
- $\left\{ \begin{array}{c} \text{COMM} \\ \text{NOCOMM} \end{array} \right\}$ A device list choice of communications equipment.
- $\left\{ \begin{array}{c} \text{DASD} \\ \text{NODASD} \end{array} \right\}$ A device list choice of direct access storage devices.
- $\left\{ \begin{array}{c} \text{GRAPH} \\ \text{NOGRAPH} \end{array} \right\}$ A device list choice of graphic devices.
- $\left\{ \begin{array}{c} \text{TAPE} \\ \text{NOTAPE} \end{array} \right\}$ A device list choice of magnetic tape devices.
- $\left\{ \begin{array}{c} \text{UNITR} \\ \text{NOUNITR} \end{array} \right\}$ A device list choice of unit record devices.
- INTERVAL** $\left\{ \begin{array}{c} \text{value} \\ \text{value M} \end{array} \right\}$ Specifies the interval at which all data will be gathered for report formatting and/or SMF record writing.
- MEMBER (nn)** The value specified by this parameter is appended to IRBMF1 to form the name of the partitioned data set that contains the MF/1 options.
- $\left\{ \begin{array}{c} \text{OPTIONS or OPTN} \\ \text{NOOPTIONS or NOOPTN} \end{array} \right\}$ Specifies whether or not a list of the keyword options to be used will be printed at the operator's console at MF/1 initialization.

OS/VS2 MVS SYSTEM COMMANDS

Starting (MF/1) contd.

{ PAGING }
{ NOPAGING } Specifies whether or not the system paging activity is to be monitored by MF/1.

{ REPORT { REALTIME } }
{ NOREPORT { DEFER } } Specifies whether or not printed reports of the monitored data are to be produced.

{ STOP (value) }
{ (value M) }
{ (value H) }
{ NOSTOP } Specifies the desired time duration of MF/1 activity in minutes or hours.

SYSOUT (class) Specifies the SYSOUT class to which formatted reports are directed.

{ RECORD }
{ NORECORD } Specifies whether or not the monitored data is to be written to the SMF data set.

{ WKLD (PERIOD) }
{ (GROUP) }
{ (SYSTEM) }
{ NOWKLD } Specifies whether or not system workload activity is to be monitored by MF/1.

Starting GTF (Generalized Trace Facility)

{ START } S	{ GTF } procname [.identifier] [, [devicetype], [volumeserial]] [, ([MODE={INT}] [, BUF=nnn] [, TIME=YES]) { EXT } [, DEBUG=YES]] [, MEMBER=xxxxxxxx] [, REGION=nnnnK] [, keyword=option [, keyword=option] ...]
------------------------------	---

STOP (P)

Stopping a Job

{ STOP } P	jobname
-----------------------------	---------

OS/VS2 MVS SYSTEM COMMANDS

Stopping Writers

{STOP P}	[procname.]identifier
-------------	-----------------------

Stopping MF/1

{STOP P}	{MF1.identifier procname.identifier identifier}
-------------	---

Stopping GTF

{STOP P}	identifier
-------------	------------

STOPMN (PM)

Stopping the Continual Display of Data Set Status

{STOPMN PM}	{DSNAME SPACE STATUS}
----------------	-----------------------------

Stopping the Continual Display of Job Status

{STOPMN PM}	JOBNAMES
----------------	----------

Stopping Terminal Monitoring

{STOPMN PM}	SESS
----------------	------

OS/VS2 MVS SYSTEM COMMANDS

STOPTR (PT)

Changing the TRACK Command Output

{ STOPTR PT }	{ TS JOBS J A }	[, L = { a cc cca }]
------------------------	--------------------------------	------------------------------------

SWAP (G)

Operator Requested DDR

{ SWAP G }	{ OFF ON xxx, yyy }
---------------------	---------------------------------

SWITCH (I)

{ SWITCH I }	SMF
-----------------------	-----

TRACE

Controlling System Tracing after Subsystem Initialization

TRACE	{ ON OFF STATUS }
-------	-------------------------------

TRACK (TR)

Displaying System Status on Display Consoles

{ TRACK TR }	{ TS JOBS J A }	[{ LIST }]	[, L = { a cc cca }]
-----------------------	--------------------------------	--------------------	------------------------------------

OS/VS2 MVS SYSTEM COMMANDS

UNLOAD (U)

Unloading Volumes

{UNLOAD} U	unitaddr
---------------	----------

VARY (V)

Assigning and Controlling MCS Consoles

{VARY} V	CN(consoleid[,consoleid]...) ,AUTH={ ALL INPO {[SYS][,IO][,CONS]} }
	{ unitaddr O-unit (I-unit,O-unit) } [{ unitaddr O-unit (I-unit,O-unit) } ...]
	,CONSOLE [,AUTH={ ALL INPO {[SYS][,IO][,CONS]} } ,ROUT={ NONE (routecode[,routecode]...) } ,ALTCONS={ unitaddr O-unit (I-unit,O-unit) }]

Note: A single device address, AUTH=operand, or routecode need not be enclosed in parentheses. A single console must be enclosed in parentheses.

Changing the Master Console

{VARY} V	{unitaddr (I-unit,O-unit)}	,MSTCONS
-------------	-------------------------------	----------

OS/VS2 MVS SYSTEM COMMANDS

Controlling the Hardcopy Log

<pre>{ VARY } { V }</pre>	<pre>[unitaddr],HARDCPY [SYSLOG]</pre>	<pre>,NOCMDS ,INCMDS ,STCMDS ,CMDS ,OFF ,ROUT={ ALL NONE (routecode) [,routecode]... }</pre>
---------------------------	--	--

Changing the Status of a Secondary Console

<pre>{ VARY } { V }</pre>	<pre>([unitaddr O-unit (I-unit,O-unit)] [,unitaddr ,O-unit ,(I-unit,O-unit)] ...) { ,OFFLINE } { ,ONLINE }</pre>
---------------------------	---

Placing an I/O Device Online or Offline

<pre>{ VARY } { V }</pre>	<pre>(unitaddr[,unitaddr]...), { ONLINE } { OFFLINE }</pre>
---------------------------	---

Placing a Range of I/O Devices Online or Offline

<pre>{ VARY } { V }</pre>	<pre>{ xxx-yyy (xxx-yyy[,aaa-bbb]...) } { ONLINE } { OFFLINE }</pre>
---------------------------	--

Placing a Path Online or Offline

<pre>{ VARY } { V }</pre>	<pre>PATH(unitaddr[,x]), { ONLINE } { OFFLINE[,UNCOND] }</pre>
---------------------------	--

OS/VS2 MVS SYSTEM COMMANDS

Placing Storage Online or Offline

$\left\{ \begin{array}{c} \text{VARY} \\ \text{V} \end{array} \right\}$	STOR($\left\{ \begin{array}{l} \text{ddddK, ddddK} \\ \text{xxxxxx, xxxxxx} \\ \text{ddM, ddM} \end{array} \right\}$), $\left\{ \begin{array}{l} \text{ONLINE} \\ \text{OFFLINE} \end{array} \right\}$
---	--

Placing a Channel Online or Offline

$\left\{ \begin{array}{c} \text{VARY} \\ \text{V} \end{array} \right\}$	CH $\left\{ \begin{array}{l} (x) \\ (x, y) \end{array} \right\}$, $\left\{ \begin{array}{l} \text{ONLINE} \\ \text{OFFLINE[, UNCOND]} \end{array} \right\}$
---	--

Placing a CPU Online or Offline

$\left\{ \begin{array}{c} \text{VARY} \\ \text{V} \end{array} \right\}$	CPU(n), $\left\{ \begin{array}{l} \text{ONLINE} \\ \text{OFFLINE[, UNCOND]} \end{array} \right\}$
---	---

WRITELOG (W)

Scheduling System Log Output

$\left\{ \begin{array}{c} \text{WRITELOG} \\ \text{W} \end{array} \right\}$	
---	--

Changing the System Log Output Class

$\left\{ \begin{array}{c} \text{WRITELOG} \\ \text{W} \end{array} \right\}$	class
---	-------

Closing the System Log

$\left\{ \begin{array}{c} \text{WRITELOG} \\ \text{W} \end{array} \right\}$	CLOSE
---	-------

Restarting the System Log

$\left\{ \begin{array}{c} \text{WRITELOG} \\ \text{W} \end{array} \right\}$	START
---	-------

OS/VS2 JES2 OPERATOR COMMANDS

VS2 Release 3.7

Source: GC38-0210-4 Operator's Library:
OS/VS2 (JES2)
VS2 Release 3.7

RELEASE (\$A)

Releasing All Jobs

\$A	A	[,system-id] [,ALL]
-----	---	------------------------

Releasing Job Queues

\$A	Q[,classes]
-----	-------------

Releasing Specified Jobs

\$A	{ {Jn[-n]} [, [J]n[-n]] {Sn[-n]} [, [S]n[-n]] ... {Tn[-n]} [, [T]n[-n]] 'jobname' }
-----	---

BACKSPACE (\$B)

Logically Backspacing a Printer

\$B	{PRTn Rn.PRn} [,n] [,D] [,PRTn [,n]] ...
-----	---

Logically Backspacing Punch Output

\$B	{PUNn Rn.PUN} [,n] [,D] [,PUNn [,n]] ...
-----	---

OS/VS JES2 OPERATOR COMMANDS

CANCEL (\$C)

Canceling Reader Activity

\$C	{RDRn } [,RDRn] ... {Rn.RDn } [,Rn.RDn] ...
-----	--

Canceling Printer Output

\$C	{PRTn } [,PRTn] ... {Rn.PRn } [,Rn.PRn] ...
-----	--

Canceling Punch Output

\$C	{PUNn } [,PUNn] ... {Rn.PUn } [,Rn.PUn] ...
-----	--

Canceling and Deleting All Automatic Commands

\$C	A
-----	---

Canceling a Job

\$C	{ {Jn[-n]} [, [J]n[-n]] ... } [, D] { {Sn[-n]} [, [S]n[-n]] ... } [, P] { {Tn[-n]} [, [T]n[-n]] ... } 'jobname'
-----	--

DISPLAY (\$D)

Displaying Initiator Information

\$D	I [n[-n]]
-----	-----------

OS/VS2 JES2 OPERATOR COMMANDS

DISPLAY (contd.)

Communicating with JES2 Remote Terminals

\$D	Mn[-n], 'message'
-----	-------------------

Displaying the Status of JES2-Controlled Devices

\$D	U	$\left[\begin{array}{l} ,ALL \\ ,LNEn \\ ,LNES \\ ,PRTS \\ ,PUNS \\ ,RMTS \\ ,RMTn \\ ,RDRS \\ ,RDI \\ ,device[,device]... \end{array} \right]$	$\left[,L= \left\{ \begin{array}{l} a \\ cc \\ cca \end{array} \right\} \right]$
-----	---	--	---

Displaying Subsystem Operator Requests

\$D	O	$\left[,L= \left\{ \begin{array}{l} a \\ cc \\ cca \end{array} \right\} \right]$
-----	---	---

Displaying Information on Specified Jobs

Note: An asterisk (*) will appear if the job is not queued by class.

\$D	$\left\{ \begin{array}{l} \{Jn[-n]\} \\ \{Sn[-n]\} \\ \{Tn[-n]\} \end{array} \right\} \left[\begin{array}{l} [, [J]n[-n]] \\ [, [S]n[-n]] \\ [, [T]n[-n]] \end{array} \right] \dots \left[,L= \left\{ \begin{array}{l} a \\ cc \\ cca \end{array} \right\} \right]$	$\left. \begin{array}{l} 'jobname' \end{array} \right\}$
-----	---	--

OS/VS2 JES2 OPERATOR COMMANDS

Displaying Job Queue Information

\$D	N	[,system-id] [,IND] [,n[-n]]	[class {STC} { \$ {TSU} { e *]]	[,L={ a cc cca }]
			,XEQ ,OUT ,PPU ,HOLD	

Displaying the Number of Jobs Queued

\$D	Q	[,system-id] [,IND] [,n[-n]]	[class {STC} { \$ {TSU} { e *]]	[,L={ a cc cca }]
			,XEQ ,OUT ,PPU ,HOLD	

Displaying the Job Output Forms Queue

\$D	F	[,n[-n]]	[,Jn[-n] ,Sn[-n] ,Tn[-n]]	... [,H ,A]	[,L={ a cc cca }]
-----	---	----------	---------------------------------	------------------	--------------------------

Displaying Information About Currently Active Jobs

\$D	A	[,JOB] [,STC] [,TSU] [,XEQ] [,DEV]
		[,system-id] [,L={ a cc cca }]

OS/VS2 JES2 OPERATOR COMMANDS

RESTART (\$E)

Restarting a JES2 Subsystem in the Complex

\$E	SYS,system-id
-----	---------------

Restarting Printer Activity

\$E	{PRTn Rn.PRn} [,PRTn Rn.PRn] ...
-----	--

Discontinuing Punch Activity

\$E	{PUNn Rn.PUN} [,PUNn Rn.PUN] ...
-----	--

Restarting Line Activity

\$E	LNEn [,LNEn] ...
-----	------------------

Restarting Specified Jobs in Execution

\$E	{Jn[-n] [, [J]n[-n]] ... } 'jobname'
-----	---

LOGICAL FORWARD SPACING (\$F)

Logically Forward-Spacing a Printer

\$F	{PRTn Rn.PRn} [,n D] [,PRTn Rn.PRn [,n D]] ...
-----	--

OS/VS2 JES2 OPERATOR COMMANDS

Logically Forward-Spacing Punch Output

\$F	{PUNn Rn.PUn} [,n] [,PUNn [,n] [,D] [,Rn.PUn [,D]] ...
-----	---

HOLD (\$H)

Holding All Jobs

\$H	A [,system-id [,ALL]
-----	----------------------------

Holding Job Queues

\$H	Q [,classes]
-----	----------------

Holding Specified Jobs

\$H	{ { Jn[-n] Sn[-n] Tn[-n] } [, [J] n[-n] [, [S] n[-n]] ... [, [T] n[-n]] } 'jobname'
-----	--

INTERRUPT (\$I)

Interrupting Printer Activity

\$I	{ PRTn Rn.PRn } [, PRTn [, Rn.PRn]] ...
-----	---

OS/VS2 JES2 OPERATOR COMMANDS

Interrupting Punch Activity

\$I	$\left\{ \begin{array}{l} \text{PUNn} \\ \text{Rn.PUn} \end{array} \right\} \left[, \text{PUNn} \right] \dots$
-----	---

LIST (\$L)

Listing Job Output Information

\$L	$\left\{ \begin{array}{l} \text{Jn[-n]} \\ \text{Sn[-n]} \\ \text{Tn[-n]} \\ \text{'jobname'} $
-----	---

Listing the Current System Identifier Status

\$L	SYS
-----	-----

REPEAT (\$N)

Repeating Printer Output

\$N	$\left\{ \begin{array}{l} \text{PRTn} \\ \text{Rn.PRn} \end{array} \right\} \left[, \text{PRTn} \right] \dots$
-----	---

Repeating Punch Output

\$N	$\left\{ \begin{array}{l} \text{PUNn} \\ \text{Rn.PUn} \end{array} \right\} \left[, \text{PUNn} \right] \dots$
-----	---

OS/VS2 JES2 OPERATOR COMMANDS

RELEASE (\$O)

Controlling Held Output Data Sets

\$O	{ Jn[-n] Sn[-n] Tn[-n] 'jobname' }	[,Q=classes] [,C]	[,Rn ,LOCAL]
-----	---	-------------------	-------------------

Releasing or Canceling Held Output

\$O	Q [,CANCEL]	[,RN ,LOCAL]	[,Q=classes]
-----	-------------	-------------------	--------------

STOP (\$P)

Stopping JES2

\$P	
-----	--

Withdrawing JES2 from the System

\$P	JES2
-----	------

Stopping a Reader

\$P	{ RDRn Rn.RDn } [,RDRn ,Rn.RDn] ...
-----	---

Stopping an Initiator

\$P	I [n[-n]]
-----	-----------

OS/VS2 JES2 OPERATOR COMMANDS

Stopping a Printer

\$P	{ PRTn Rn.PRn } [, PRTn Rn.PRn] ...
-----	---

Stopping a Punch

\$P	{ PUNn Rn.PUn } [, PUNn Rn.PUn] ...
-----	---

Stopping a Remote Job Entry Line

\$P	LNEn [, LNEn] ...
-----	---------------------

Stopping a Job

\$P	$\left\{ \begin{array}{l} \{ Jn[-n] \\ Sn[-n] \\ Tn[-n] \} \left[\begin{array}{l} [, J]n[-n] \\ [, S]n[-n] \\ [, T]n[-n] \end{array} \right] \dots \end{array} \right\} [Q=classes]$ 'jobname'
-----	--

Stopping Output Data Sets

\$P	Q { Q=classes Rn , LOCAL } [Q=classes Rn , LOCAL]
-----	---

ROUTE (\$R)

Routing Job Output

\$R	$\left\{ \begin{array}{l} \text{ALL, for-id, to-id [, Q=class]} \\ \{ \text{PRT} \}, \text{for-id, to-id} \\ \{ \text{PUN} \} \end{array} \right\}$
-----	---

OS/VS2 JES2 OPERATOR COMMANDS

START (\$S)

Starting or Warmstarting System Activity

\$S	
-----	--

Starting a System Input Reader

\$S	{ RDRn Rn.RDn } [, RDRn Rn.RDn] ...
-----	---

Starting an Initiator

\$S	I [n[-n]]
-----	-----------

Starting a Printer

\$S	{ PRTn RN.PRn } [, PRTn Rn.PRn] ...
-----	---

Starting a Punch

\$S	{ PUNn Rn.PUn } [, PUNn Rn.PUn] ...
-----	---

Starting Remote Job Entry Lines

\$S	LNEn [, LNEn] ...
-----	---------------------

Starting Automatic Command Processing

\$S	A
-----	---

OS/VS2 JES2 OPERATOR COMMANDS

ASSIGN (\$T)

Assigning Command Authority for a Reader

\$T	{ RDRn } , A=n RDI
-----	-----------------------

Assigning System Affinity to a Reader

\$T	{ RDRn } [, H= { Y N }] [, S= [+] { ANY IND system-id... [, system-id] } ...] RDI Rn.RDn
-----	--

Assigning Job and Message Classes to a Reader

\$T	{ RDRn } [, C=class] [, Q=class] RDI Rn.RDn
-----	---

Assigning Initiator Job Classes

\$T	I [n [-n]] , classes
-----	--------------------------

Setting Printer Characteristics

Note: You should either issue a \$P PRTn command and wait for the device to drain before entering the \$T command or issue the \$T command while the system is waiting for forms to be loaded.

\$T	{ PRTn } [, C=id] [, T=id] [, F=form] [, F=AUTOM] Rn.PRn
-----	---

OS/VS2 JES2 OPERATOR COMMANDS

Setting Printer Options

\$T	$\left\{ \begin{array}{l} \text{PRTn} [, P = \{ Y \}] \\ \text{Rn.PRn} \end{array} \right\} \left[\begin{array}{l} K = \{ 1 \\ 2 \\ 3 \\ R \} \end{array} \right] \left[S = \{ Y \} \right]$
-----	--

Assigning Printer Output Classes

\$T	$\left\{ \begin{array}{l} \text{PRTn} \\ \text{Rn.PRn} \end{array} \right\} , Q = \text{classes}$
-----	---

Setting Punch Controls

Note: This command is valid only when the specified device is inactive.

\$T	$\left\{ \begin{array}{l} \text{PUNn} \\ \text{Rn.PUn} \end{array} \right\} \left[P = \{ Y \} \right] \left[S = \{ Y \} \right] \left[F = \text{form} \right] \left[F = \text{AUTOM} \right]$
-----	---

Assigning Punch Output Classes

\$T	$\left\{ \begin{array}{l} \text{PUNn} \\ \text{Rn.PUn} \end{array} \right\} , Q = \text{classes}$
-----	---

Assigning a Password to a Line

\$T	$\text{LNE n} , P = \{ \text{password} \}$
-----	--

Diagnosing Line Problems

\$T	$\text{LNE n} , E = \left\{ \begin{array}{l} Y \\ N \end{array} \right\}$
-----	---

OS/VS2 JES2 OPERATOR COMMANDS

Changing a System's Operational Mode

\$T	SYS, IND= $\begin{Bmatrix} Y \\ N \end{Bmatrix}$
-----	--

Altering System Message Output

\$T	$\begin{Bmatrix} OSCn \\ Rn.CON \end{Bmatrix}$ $\left[, D = \begin{Bmatrix} T \\ J \\ M \end{Bmatrix} \right]$
-----	---

JES2 Message Routing

\$T	C, importance-level, routecode[, routecode]...
-----	--

Routing JES2 Status Information

\$T	M $\begin{Bmatrix} a \\ cc \\ cca \end{Bmatrix}$ [, operands] $\left[, L = \begin{Bmatrix} a \\ cc \\ cca \end{Bmatrix} \right]$
-----	---

Displaying, Specifying, and Respecifying Automatic Commands

\$T	A[cccc] $\left[\left\{ , I = ssss \right\} , 'command[;command] \dots ' \right]$ $\left[, T = hh.mm \right]$ $\left[, L = \begin{Bmatrix} a \\ cc \\ cca \end{Bmatrix} \right]$
-----	--

Deleting an Automatic Command Entry

\$T	Acccc, CANCEL
-----	---------------

Setting the JES2 internal Job Numbers

\$T	$\begin{Bmatrix} Jn \\ Sn \\ Tn \end{Bmatrix}$
-----	--

OS/VS2 JES2 OPERATOR COMMANDS

Changing JES2 System Affinity for Work

\$T	ALL , {system-id}, [+] { IND { ANY { IND { system-id...[,system-id] } ...
-----	---

Changing a Job's Class, Scheduling Priority, or System Identifier

\$T	{ Jn [-n] Sn [-n] Tn [-n] 'jobname' } { P= { +n -n } S= { + } { ANY - } { IND system-id...[,system-id] } { ... } C=class S= { + } { ANY - } { IND system-id...[,system-id] } { ... }
-----	---

JES2 SYSTEM COMMAND ROUTING

Entering System Commands Via JES2

\$VS	, 'command' [, 'command'] ...
------	-------------------------------

HALT

Halting a Reader

#Z	{ RDRn Rn.RDn } [, RDRn] ... [, Rn.RDn]
----	---

OS/VS2 JES2 OPERATOR COMMANDS

Stopping an Initiator

\$Z	I[n[-n]]
-----	----------

Halting Printing Activity

\$Z	{PRTn Rn.PRn} [,PRTn Rn.PRn] ...
-----	--

Halting Punch Activity

\$Z	{PUNn Rn.PUn} [,PUNn Rn.PUn] ...
-----	--

Halting Automatic Command Processing

\$Z	A
-----	---

OS/VS2 JES3 OPERATOR COMMANDS

VS2 Release 3.7

Source: GX23-0003 JES3 Operator Commands
and Dynamic Support Programs
GC38-0226 Operator's Library: OS/VS2
Reference (JES3)

NOTE: UNLESS OTHERWISE INDICATED, COMMANDS ARE ONLY
PERMITTED FROM JES3 CONSOLES ON GLOBAL.

COMMAND VERB	PARAMETERS
{ *CALL } { *X }	,dspname [,message-text]
{ *CANCEL } { *C }	, { dspname device-name device-address line-name main-processor-name } [,message-text]
{ *DELAY } { *D }	, { 0 1/4 1/2 1 2 ... 20 }
{ *DISABLE } { *H }	,console-name
*DUMP	[,title] [,password]
{ *ENABLE } { *N }	,console-name
{ *ERASE } { *E }	
*FAIL	, { dspname device-name device-address J=jnn } [,DUMP]
*FREE	

OS/VS2 JES3 OPERATOR COMMANDS

COMMAND VERR	PARAMETERS
{*INQUIRY } {*I }	
Active	,A { ,system-name ,D=dspname ,D=ALL blank }
Backlog	,B { ,M ,system-name blank ,T=group-name }
Buffer Pools	,C { blank ,C ,C,R }
JES3 Managed Devices	,D { blank ,D=(device-name, ...) [,N= $\frac{10}{nnn}$] ALL ,L= { (line-name, ...) } ALL ,T= { (terminal-name, ...) } ALL ,(system-name, ...)) ,V=(vol-ser, ...) }
Generalized Main	,G,system-name, { { S SELECT } [(opt, ...)] { G GROUP } [(group, ...)] { C CLASS } [(class, ...)] CHK SMR }
JES3 JOB QUEUE	,J { (jjj, ...) } [,E] [,T=termgrp] { (jnn, ...) } [blank] { (jj*, ...) }
PFK and SP Tables	,K { ,N [=nn],N=(table, ...) }
Deadline	,L [,T=(type, ...)]

OS/VS2 JES3 OPERATOR COMMANDS

COMMAND VERB	PARAMETERS
*INQUIRY (cont'd)	
MCS Route Codes	,M,system-name [, (code, . . .)]
DJC Networks	,N $\left\{ \begin{array}{l} \text{blank} \\ ,ID=(\text{net}, \dots) \end{array} \right. \left[\begin{array}{l} ,J= \left\{ \begin{array}{l} (jjj, \dots) \\ (jnn, \dots) \end{array} \right\} \\ ,LIST \end{array} \right] \right\}$
Consoles	,O $\left\{ \begin{array}{l} \text{blank} \\ =(console, \dots) ! * \\ \\ =(console, \dots) \left\{ \begin{array}{l} [,K] \\ [,system-name] \\ [,DEST] \end{array} \right\} \end{array} \right\}$
Priorities	,P=prty $\left[\begin{array}{l} ,N= \left\{ \begin{array}{l} 10 \\ nnn \\ ALL \end{array} \right\} \end{array} \right] \left[\begin{array}{l} ,T=terminal- \\ .name \end{array} \right]$
Job Queue Status	,Q $\left(\begin{array}{l} ,S \\ D=dspname \\ ,r \\ \\ \left\{ \begin{array}{l} ,C = Class \\ ,G = Group \\ ,J = jnn \\ blank \end{array} \right\} \left[\begin{array}{l} ,N= \left\{ \begin{array}{l} 10 \\ nnn \\ ALL \end{array} \right\} \end{array} \right] \end{array} \right)$
Outstanding Replies	,R $\left\{ \begin{array}{l} \text{blank} \\ ,system-name \\ ,dspname \\ \\ \left\{ ,S \right\} \left\{ \begin{array}{l} \text{blank} \\ ,J=jnn \\ ,C=sdest \end{array} \right\} \end{array} \right\}$

OS/VS2 JES3 OPERATOR COMMANDS

COMMAND VERB	PARAMETERS
<p>*INQUIRY (cont'd)</p> <p>MDS Setup</p> <p>RJP Lines</p> <p>Output Service</p>	<p> $\left. \begin{array}{l} ,F \\ ,W \\ ,V \\ ,B \\ \left\{ \begin{array}{l} ,A \\ ,U \\ ,E \\ ,R \end{array} \right\} \\ ,D=\text{data-set-name} \\ ,V= \left\{ \begin{array}{l} \text{vol-ser} \\ \text{ALL} \\ \text{RES} \end{array} \right\} \\ \text{blank} \end{array} \right\} [,J=\text{jnn}] [,E]$ </p> <p> $,T,L= \left\{ \begin{array}{l} \text{line-name} \\ \text{ALL} \end{array} \right\} [,P] [,STAT [,R]]$ </p> <p> $,U$ </p> <p> $,J=? \left[,N= \left\{ \begin{array}{l} 10 \\ \text{nnn} \\ \text{ALL} \end{array} \right\} \right]$ </p> <p> $,J= \left\{ \begin{array}{l} \text{jjj} \\ \text{jnn} \end{array} \right\} ,DD= \left\{ \begin{array}{l} ? \\ \text{ddname} \end{array} \right\} [,S= \left\{ \begin{array}{l} 1 \\ \text{nn} \end{array} \right\}]]$ </p> <p> $,J= \left\{ \begin{array}{l} \text{jjj} \\ \text{jnn} \end{array} \right\} ,REQ=?$ </p>

OS/VS2 JES3 OPERATOR COMMANDS

COMMAND VERB	PARAMETERS
<p>*INQUIRY (cont'd)</p> <p>Output Service (cont'd)</p>	<div style="display: flex; justify-content: space-between; align-items: center;"> <div style="border: 1px solid black; padding: 5px;"> <p>[,J= { ijj } jnn }]</p> </div> <div style="border: 1px solid black; padding: 10px; text-align: center;"> <p>,CL= { ? class }</p> <p>,D= { ? destination- name }</p> <p>,F= { ? form-name }</p> <p>,H= { ? YIN }</p> <p>,ID= { ? user-id }</p> <p>,L= { ? minimum-line -count }</p> <p>,P= { ? priority }</p> <p>,T= device-group</p> <p>,C= { ? carriage-tape }</p> <p>,GT= { PRT/PUN/TSO }</p> <p>,ST= { ? device-type }</p> <p>,U= { ? train-name }</p> </div> <div style="border: 1px solid black; padding: 5px;"> <p>[,N= $\frac{10}{nnn}$ ALL]</p> </div> </div> <p>[,CONS=console-name]</p> <p>NOTE: The following pertains only to the JES3 support of the IBM 3800 Printer Subsystem and is provided for planning purposes only.</p> <p>,U { (img1 [, img2, img3, img4]) ? img }</p> <p>,CH= { ? img }</p>

OS/VS2 JES3 OPERATOR COMMANDS

COMMAND VERB	PARAMETERS
*INQUIRY (cont'd) Output Service (cont'd)	<p data-bbox="339 248 453 275">,U (cont'd)</p> <p data-bbox="373 296 605 363">,FL= $\left\{ \begin{array}{l} fLid \\ ? \\ NONE \end{array} \right\}$</p> <p data-bbox="373 398 650 571">,CM= $\left\{ \begin{array}{l} cmid \\ (cmid, trc) \\ ? \\ NONE \end{array} \right\}$</p> <p data-bbox="373 606 567 709">,SS= $\left\{ \begin{array}{l} C \\ S \\ ? \end{array} \right\}$</p> <p data-bbox="339 730 913 786">NOTE: The following apply only to data sets on the Output Service HOLDqueue (,Q=HOLD must be coded).</p> <p data-bbox="339 807 899 920">NOTE: DD= and DSID= are mutually exclusive. Other data set characteristic keywords may be combined to more fully qualify request. J= and N= limiters are the same as before.</p> <p data-bbox="350 924 582 984">,Q=HOLD $\left[J = \left\{ \begin{array}{l} jjj \\ jnn \end{array} \right\} \right]$</p> <p data-bbox="457 991 864 1301"> $\left\{ \begin{array}{l} ,DSID = \left\{ \begin{array}{l} ? \\ \text{data-} \\ \text{set-id} \end{array} \right\} \\ ,W = \left\{ \begin{array}{l} ? \\ \text{external-} \\ \text{writer-} \\ \text{name} \end{array} \right\} \end{array} \right\} \left[N = \left\{ \begin{array}{l} 10 \\ nnn \\ ALL \end{array} \right\} \right]$ </p> <p data-bbox="350 1308 468 1335">,REQ=ALL</p> <p data-bbox="406 1372 665 1573"> $\left[\begin{array}{l} ,J = \left\{ \begin{array}{l} jjj \\ jnn \end{array} \right\} \\ ,DD = \left\{ \begin{array}{l} ddn[s=nn] \\ ? \end{array} \right\} \\ ,Q = \left\{ \begin{array}{l} WTR \\ HOLD \end{array} \right\} \end{array} \right]$ </p>

OS/VS2 JES3 OPERATOR COMMANDS

COMMAND VERB	PARAMETERS																													
DSP and Module Use Counts	,X { <table border="0" style="display: inline-table; vertical-align: middle;"> <tr> <td style="padding-right: 10px;">,D=</td> <td>{ dspname }</td> </tr> <tr> <td></td> <td>{ ALL }</td> </tr> <tr> <td style="padding-right: 10px;">,M=</td> <td>{ module-name }</td> </tr> <tr> <td></td> <td>{ ALL }</td> </tr> </table>	,D=	{ dspname }		{ ALL }	,M=	{ module-name }		{ ALL }																					
,D=	{ dspname }																													
	{ ALL }																													
,M=	{ module-name }																													
	{ ALL }																													
{ *MESSAGE } { *Z }	{ <table border="0" style="display: inline-table; vertical-align: middle;"> <tr> <td style="padding-right: 10px;">,console-name</td> <td rowspan="2" style="font-size: 2em; vertical-align: middle;">}</td> <td rowspan="2" style="padding-left: 10px;">,text</td> </tr> <tr> <td>,destination-class</td> </tr> </table> ,ALL	,console-name	}	,text	,destination-class																									
,console-name	}	,text																												
,destination-class																														
{ *MODIFY } { *F } Event Tracing	{ <table border="0" style="display: inline-table; vertical-align: middle;"> <tr> <td style="padding-right: 10px;">,ON</td> <td rowspan="2" style="font-size: 2em; vertical-align: middle;">}</td> </tr> <tr> <td>,OFF</td> </tr> <tr> <td style="padding-right: 10px;">,START=</td> <td>{ PGMCHK }</td> </tr> <tr> <td></td> <td>{ RESUME }</td> </tr> <tr> <td style="padding-right: 10px;">,STOP=</td> <td>{ PGMCHK }</td> </tr> <tr> <td></td> <td>{ WAIT }</td> </tr> <tr> <td style="padding-right: 10px;">,E</td> <td rowspan="2" style="font-size: 2em; vertical-align: middle;">}</td> <td style="padding-left: 10px;">,EXCL=</td> <td>{ id }</td> </tr> <tr> <td></td> <td>{ RESET }</td> </tr> <tr> <td style="padding-right: 10px;">,LIMIT=</td> <td>nnn</td> </tr> <tr> <td style="padding-right: 10px;">,DUMP=</td> <td>{ id }</td> </tr> <tr> <td></td> <td>{ ALL }</td> </tr> <tr> <td style="padding-right: 10px;">,DISPLAY</td> <td></td> </tr> <tr> <td style="padding-right: 10px;">,TRAP=</td> <td>{ addr }</td> </tr> <tr> <td></td> <td>{ RESET }</td> </tr> </table>	,ON	}	,OFF	,START=	{ PGMCHK }		{ RESUME }	,STOP=	{ PGMCHK }		{ WAIT }	,E	}	,EXCL=	{ id }		{ RESET }	,LIMIT=	nnn	,DUMP=	{ id }		{ ALL }	,DISPLAY		,TRAP=	{ addr }		{ RESET }
,ON	}																													
,OFF																														
,START=	{ PGMCHK }																													
	{ RESUME }																													
,STOP=	{ PGMCHK }																													
	{ WAIT }																													
,E	}	,EXCL=	{ id }																											
		{ RESET }																												
,LIMIT=	nnn																													
,DUMP=	{ id }																													
	{ ALL }																													
,DISPLAY																														
,TRAP=	{ addr }																													
	{ RESET }																													
Generalized Main	{ <table border="0" style="display: inline-table; vertical-align: middle;"> <tr> <td style="padding-right: 10px;">,G,system-name</td> <td rowspan="2" style="font-size: 2em; vertical-align: middle;">}</td> <td rowspan="2" style="padding-left: 10px;">{ <table border="0" style="display: inline-table; vertical-align: middle;"> <tr> <td style="padding-right: 10px;">,G</td> <td rowspan="2" style="font-size: 2em; vertical-align: middle;">}</td> <td style="padding-left: 10px;">,group-name</td> </tr> <tr> <td>,GROUP</td> <td></td> </tr> </table> ,ON ,OFF ,INIT,nnn ,ALLOC,opt ,UNALLOC,opt </td> </tr> <tr> <td style="padding-right: 10px;">{ <table border="0" style="display: inline-table; vertical-align: middle;"> <tr> <td style="padding-right: 10px;">,S</td> <td rowspan="2" style="font-size: 2em; vertical-align: middle;">}</td> <td style="padding-left: 10px;">,option, value</td> </tr> <tr> <td>,SELECT</td> <td></td> </tr> </table> } </td> <td></td> </tr> <tr> <td style="padding-right: 10px;">{ <table border="0" style="display: inline-table; vertical-align: middle;"> <tr> <td style="padding-right: 10px;">,C</td> <td rowspan="2" style="font-size: 2em; vertical-align: middle;">}</td> <td style="padding-left: 10px;">,class-name</td> </tr> <tr> <td>,CLASS</td> <td></td> </tr> </table> ,CHK </td> <td>[<table border="0" style="display: inline-table; vertical-align: middle;"> <tr> <td style="padding-right: 10px;">,ON</td> <td rowspan="2" style="font-size: 2em; vertical-align: middle;">]</td> </tr> <tr> <td>,OFF</td> </tr> </table>] </td> </tr> </table>	,G,system-name	}	{ <table border="0" style="display: inline-table; vertical-align: middle;"> <tr> <td style="padding-right: 10px;">,G</td> <td rowspan="2" style="font-size: 2em; vertical-align: middle;">}</td> <td style="padding-left: 10px;">,group-name</td> </tr> <tr> <td>,GROUP</td> <td></td> </tr> </table> ,ON ,OFF ,INIT,nnn ,ALLOC,opt ,UNALLOC,opt	,G	}	,group-name	,GROUP		{ <table border="0" style="display: inline-table; vertical-align: middle;"> <tr> <td style="padding-right: 10px;">,S</td> <td rowspan="2" style="font-size: 2em; vertical-align: middle;">}</td> <td style="padding-left: 10px;">,option, value</td> </tr> <tr> <td>,SELECT</td> <td></td> </tr> </table> }	,S	}	,option, value	,SELECT			{ <table border="0" style="display: inline-table; vertical-align: middle;"> <tr> <td style="padding-right: 10px;">,C</td> <td rowspan="2" style="font-size: 2em; vertical-align: middle;">}</td> <td style="padding-left: 10px;">,class-name</td> </tr> <tr> <td>,CLASS</td> <td></td> </tr> </table> ,CHK	,C	}	,class-name	,CLASS		[<table border="0" style="display: inline-table; vertical-align: middle;"> <tr> <td style="padding-right: 10px;">,ON</td> <td rowspan="2" style="font-size: 2em; vertical-align: middle;">]</td> </tr> <tr> <td>,OFF</td> </tr> </table>]	,ON]	,OFF				
,G,system-name	}	{ <table border="0" style="display: inline-table; vertical-align: middle;"> <tr> <td style="padding-right: 10px;">,G</td> <td rowspan="2" style="font-size: 2em; vertical-align: middle;">}</td> <td style="padding-left: 10px;">,group-name</td> </tr> <tr> <td>,GROUP</td> <td></td> </tr> </table> ,ON ,OFF ,INIT,nnn ,ALLOC,opt ,UNALLOC,opt			,G		}	,group-name	,GROUP																					
,G			}	,group-name																										
,GROUP																														
{ <table border="0" style="display: inline-table; vertical-align: middle;"> <tr> <td style="padding-right: 10px;">,S</td> <td rowspan="2" style="font-size: 2em; vertical-align: middle;">}</td> <td style="padding-left: 10px;">,option, value</td> </tr> <tr> <td>,SELECT</td> <td></td> </tr> </table> }	,S	}	,option, value	,SELECT																										
,S	}		,option, value																											
,SELECT																														
{ <table border="0" style="display: inline-table; vertical-align: middle;"> <tr> <td style="padding-right: 10px;">,C</td> <td rowspan="2" style="font-size: 2em; vertical-align: middle;">}</td> <td style="padding-left: 10px;">,class-name</td> </tr> <tr> <td>,CLASS</td> <td></td> </tr> </table> ,CHK	,C	}	,class-name	,CLASS		[<table border="0" style="display: inline-table; vertical-align: middle;"> <tr> <td style="padding-right: 10px;">,ON</td> <td rowspan="2" style="font-size: 2em; vertical-align: middle;">]</td> </tr> <tr> <td>,OFF</td> </tr> </table>]	,ON]	,OFF																					
,C	}		,class-name																											
,CLASS																														
,ON]																													
,OFF																														

OS/VS2 JES3 OPERATOR COMMANDS

COMMAND VERB	PARAMETERS
*MODIFY (cont'd)	
JES3 JOBS	$,J=jnn \left\{ \begin{array}{l} ,H \\ ,R \\ ,C \\ ,CP \\ ,P=prty \end{array} \right\}$
P.F. Key	$,K=nn,N=ptable,M=<text> \left\{ \begin{array}{l} ,E \\ ,D \end{array} \right\}$
Deadline	$,L,T=type$ $\left\{ \begin{array}{l} \left[,PRTY= \left\{ \begin{array}{l} +n \\ nn \end{array} \right\} \right] \\ \left[,LEAD= \left\{ \begin{array}{l} nnH \\ nnnnM \\ hhnn \end{array} \right\} \right] \\ \left[,PINC= \left\{ \begin{array}{l} +n \\ nn \end{array} \right\} \right] \\ \left[,INT= \left\{ \begin{array}{l} nnH \\ nnnnM \\ hhnn \end{array} \right\} \right] \\ \left[,ALL \right] \end{array} \right\}$
MCS Route Codes	$,M,system-name,code$ $\left[\begin{array}{l} ,[con] \\ ,[dest] \\ ,[J] \end{array} \right]$
DJC Network	$,N,ID=net-id$ $\{ ,J=(jnn, \dots) \} , \left[\begin{array}{l} I \\ D \\ H \\ R \\ C \\ F \end{array} \right]$

OS/VS2 JES3 OPERATOR COMMANDS

COMMAND VERB	PARAMETERS
<p>*MODIFY (cont'd)</p>	<p>Consoles ,O { ,M= } { ON } { ,D= } { OFF }</p> <p> =console name { ,A= { auth } { <u>15</u> } ,ADDEST=dest ,DDEST=dest ,MAIN= { main-name } { NONE } ,PFK=tab ,SP=tab }</p> <p>Job Queue ,Q [,P=prty] { ,H } { ,R }</p> <p>MDS Setup ,S { { ,VU= } ({ T-ser, ... }) { ,VA= } ({ D-ser, ... }) , M= { ddd devtyp } , system-name, ser , U=ddd, system-name , J=jnn, V , AL= { A } { M } }</p>

COMMAND VERB	PARAMETERS
<p>•MODIFY (cont'd)</p> <p>RJP Terms and Lines</p>	$ \left. \begin{array}{l} ,T= \left\{ \begin{array}{c} \text{term} \\ \text{ALL} \end{array} \right\} , \left\{ \begin{array}{l} \text{H} \\ \text{R} \\ \\ \text{B}= \left\{ \begin{array}{c} \text{nn} \\ \text{ALL} \end{array} \right\} \{ ,R \} \\ \\ \text{JOB}= \left\{ \begin{array}{c} \text{R} \\ \text{C} \end{array} \right\} \end{array} \right\} \\ \\ \\ ,L= \left\{ \begin{array}{c} \text{line} \\ \text{ALL} \end{array} \right\} , \left\{ \begin{array}{l} \text{H} \\ \text{R} \\ \\ \text{P}= \left\{ \begin{array}{c} \text{password} \\ \text{NONE} \end{array} \right\} \\ \\ \text{A} \\ \text{M} \\ \text{SNAPON/} \\ \text{SNAPOFF} \\ \\ \text{TRCEON/} \\ \text{TRCEOFF} \end{array} \right\} \end{array} \right. $
<p>Output Service</p>	<p>NOTE: Because of the many permutations of Output Service Modify commands, standard formatting is not followed. If specific keywords must be used in combination, this is indicated by including the keywords on the same line. DDNAME qualification is jobstepname.procstepname.ddname. Names that are omitted must be indicated by including the period as a qualifier (example: ..JESMSG).</p> $,U \\ ,N= \left[\begin{array}{c} \underline{10} \\ \text{nnn} \\ \text{ALL} \end{array} \right] \\ [,CONS=console-name] $

OS/VS2 JES3 OPERATOR COMMANDS

COMMAND VERB	PARAMETERS
<p>*MODIFY (cont'd)</p> <p>Output Service (cont'd)</p>	<p>,U (cont'd)</p> <p>NOTE: In general, keywords may be grouped to more fully qualify request. The Nxx keywords affect data set(s) selected on the basis of additional qualifying keywords (i.e., NF=form).</p> <p style="text-align: center;"> $\left[,J = \left\{ \begin{matrix} jjj \\ jnn \end{matrix} \right\} \right] \left[,DD=ddname[,S=nnn] \right]$ </p> <p style="text-align: center;"> [,T=device group] [,ID=user-id] [,D=dest] [,ND=ndest] [,F=form] [,NF=nform] [,L=nnn] [,CL=class] [,P=prty] [,NP=nprty] [,NCP=+ - * / mn] [,CANCEL] [,NGT=AID] </p> <p>NOTE: The following keywords apply only to data sets on the writer queue (i.e., Q=HOLD must not be coded).</p> <p style="text-align: center;"> [,Q=WTR] </p> <p style="text-align: center;"> [,GT= { PRT PUN TSO }] [,ST=typ] [,NST=ntyp] [,C=carriage (FCB)] [,NC=ncarr (FCB)] [,U=ucs-id] [,NU=nucsid] [,H=Y/N] [,NH=Y/N] </p>

COMMAND VERB	PARAMETERS
<p>*MODIFY (cont'd)</p> <p>Output Service (cont'd)</p>	<p>,U (cont'd)</p> <p>NOTE: The following pertains only to JES3 support of the 3800 Printer Subsystem and is provided for planning purposes only.</p> <p>[,FL= flid]</p> <p>[,NFL= { flid NONE }]</p> <p>[,SS= { C S }]</p> <p>[,NSS= { C S }]</p> <p>[,CM= { cmid (cmid, trc) }]</p> <p>[,NCM= { cmid (cmid trc) NONE }]</p> <p>[,CH= { img1(img1 [,img2,img3,img4]) }]</p> <p>[,NCH= (img1 [,img2,img3,img4])]</p> <p>NOTE: Following keywords apply only to data sets on the Output Service, HOLD queue (i.e., Q=HOLD must be coded):</p> <p>,Q=HOLD</p> <p>[,NQ=WTR]</p> <p>[,NCL=nclass]</p> <p>[,W=external-wtr-name]</p> <p>[,NW=next-wtr-name]</p> <p>[,DSID=dsid]</p> <p>[,NDSID=ndsid]</p> <p>[,CP=nnn]</p>

OS/VS2 JES3 OPERATOR COMMANDS

COMMAND VERB	PARAMETERS
<p>*MODIFY (cont'd)</p> <p>Output Service (cont'd)</p> <p>Vary Function</p> <p>DSP and Module Usage</p>	<p>,U (cont'd)</p> <p>,V $\left\{ \begin{array}{l} (\text{dev}, \dots) \\ (\text{ddd}, \dots) \\ (\text{ddd}-\text{ddd}) \\ \text{ctl-unit X} \\ \text{system-name} \\ \text{ALL} \\ \text{line-name} \end{array} \right\} , \left\{ \begin{array}{l} \text{ONLINE} \\ \text{ON} \\ \text{OFFLINE} \\ \text{OFF} \\ \text{CONSOLE} \end{array} \right\} [,\text{system-nm}]$</p> <p>,X $\left\{ \begin{array}{l} ,D=\text{dspname}, \text{MC}=\text{count} \\ ,M= \left\{ \begin{array}{l} \text{name} \\ \text{ALL} \end{array} \right\} , \text{RC}=\text{count} \end{array} \right\}$</p>
<p>$\left\{ \begin{array}{l} \text{*RESTART} \\ \text{*R} \end{array} \right\}$</p>	<p>$\left\{ \begin{array}{l} ,\text{dspname} \\ ,\text{device-name} \\ ,\text{device-address} \\ ,\text{system-name} \end{array} \right\} [,\text{msg-text}]$</p>
<p>*RETURN</p>	<p>[,password]</p>
<p>$\left\{ \begin{array}{l} \text{*SEND} \\ \text{*T} \end{array} \right\}$</p>	<p>,system-name, console-cmd</p>
<p>$\left\{ \begin{array}{l} \text{*START} \\ \text{*S} \end{array} \right\}$</p>	<p>$\left\{ \begin{array}{l} ,\text{dsp-name} \\ ,\text{device-name} \\ ,\text{device-address} \\ ,\text{system-name} \end{array} \right\} [,\text{msg-text or parms}]$</p>
<p>*SWITCH</p>	<p>,from-console-name, to-console-name</p>
<p>$\left\{ \begin{array}{l} \text{*VARY} \\ \text{*V} \end{array} \right\}$</p>	<p>, $\left\{ \begin{array}{l} (\text{dev}, \dots) \\ (\text{ddd}, \dots) \\ (\text{ddd}-\text{ddd}) \\ \text{ctl-unit X} \\ \text{system-name} \\ \text{ALL} \end{array} \right\} , \left\{ \begin{array}{l} \text{ONLINE} \\ \text{ON} \\ \text{OFFLINE} \\ \text{OFF} \\ \text{CONSOLE} \end{array} \right\} [,\text{system-nm}]$</p>

OS/VS2 TSO Commands

Source: GX28-0647-3 OS/VS2 TSO Command Language Reference Summary (4th Edition)

KEY

1. UPPERCASE, digits and special characters — must appear as shown.
2. Lowercase — information supplied by the user.
3. Item . . . — you may list the item more than once.
4. { } — you must specify one item.
5. [] — optional item; you may specify one.
6. KEYWORD — underlined item is the default if you do not specify one.
7. Stacked items — alternatives; specify only one item from the stack.

Operation	Operand
{ ALLOCATE } { ALLOC } <i>8 char max</i>	{ DATASET } { (*) } [FILE(name)] { DSNAME } { dsname-list } [DDNAME(name)] DUMMY { FILE(name) } [DATASET, { (*)] { DDNAME(name) } [DSNAME { (dsname-list) }] [OLD SHR MOD NEW SYSOUT[(class)]] <i>1 char, A-Z, 0-9</i> [VOLUME(serial-list)] [MSVGP(identifier)] [SPACE (quantity [,increment])] { BLOCK (value) } { BLKSIZE (value) } { AVBLOCK (value) } { TRACKS } { CYLINDERS } [DIR(integer)] <i>Default:</i> <i>(10,50) AVBLOCK(1000)</i> [DEST(userid)] [HOLD NOHOLD] [UNIT(type)] <i>1-59</i> [UCOUNT (count)] [PARALLEL]

contd. next page

OS/VS2 TSO Commands

ALLOCATE ALLOC (contd.)	[LABEL(type)] <i>1-9999</i> [POSITION (sequence-no.)] [MAXVOL (count)] [PRIVATE] <i>1-255</i> [VSEQ (vol-seq-no.)] [WSING (attr-list-name)] [RELEASE] [ROUND] [KEEP DELETE CATALOG UNCATALOG]
-------------------------------	--

OS/VS2 TSO Commands

{ATTRIB} {ATTR }	attr-list-name
	[BLKSIZE(blocksize)] <i>32,760 max</i>
	[BUFL(buffer-length)] <i>32,760 max</i>
	[BUFNO(number-of-buffers)] <i>255 max</i>
	[LRECL (({logical-record-length})) X]
	[NCP(no.-of-channel-programs)]
	[INPUT] [OUTPUT] <i>vyddd</i>
	[EXPDT(year-day)]
	[RETPD(no.-of-days)]
	[BFALN (({F}))] <i>1-4 decimal digits</i>
	[OPTCD(A,B,C,E,F,H,Q,T,W, and/or Z)]
	[EROPT (({ACC})) ({SKP})) ({ABE}))]
	[BFTEK (({S})) ({E})) ({A})) ({R}))]
	[RECFM(A,B,D,F,M,S,T,U, and/or V)]
	[DIAGNS(TRACE)] <i>32,760 max</i>
	[LIMCT (search-number)] <i>99 max</i>
	[BUFOFF (({block-prefix-length})) L]
	[DSORG (({DA})) ({DAU})) ({PO})) ({POU})) ({PS})) ({PSU}))]
	[DEN (({0})) ({1})) ({2})) ({3})) ({4}))]
	[TRTCH (({C})) ({E})) ({ET})) ({T}))]
	[KEYLEN(key-length)]

OS/VS2 TSO Commands

CALL	<pre> { dsname { dsname(membername) } ['parameter-string'] </pre>
CANCEL	<pre> (jobname [(jobid)] -list) [<u>NOPURGE</u>] [PURGE] </pre> <p style="text-align: right;"><i>1-8 alphameric char</i></p>
<pre> { DELETE } { DEL } </pre>	<pre> (entryname[/password] [. . .]) [CATALOG(catname[/password])] [FILE(ddname)] [{ PURGE } { PRG } { <u>NOPURGE</u> } { NPRG }] [ERASE] [{ NOERASE } { NERAS }] [<u>SCRATCH</u>] [{ NOSCRATCH } { NSCR }] [CLUSTER] [{ USERCATALOG } { UCAT }] [{ SPACE } { SPC }] [{ NONVSAM } { NVSAM }] [ALIAS] [{ GENERATIONDATAGROUP } { GDG }] [{ PAGESPACE } { PGSPC }] </pre>

OS/VS2 TSO Commands

<pre>{ EDIT } { E }</pre>	<pre>data-set-name[/password] [NEW] [OLD] [PLI [([integer 1 [integer 2]] [CHAR60])]] [PLIF [([integer 1 [integer 2]] [CHAR60])]] [ASM] [COBOL] [GOFORT [FREE]] [GOFORT [FIXED]] [FORTGI] [FORTH] [TEXT] [DATA] [CLIST] [CNTL] [VSBASIC] [SCAN] [NOSCAN] [NUM] [(integer1[integer2])] [NONUM] [BLOCK(integer)] [BLKSIZE(integer)] [LINE(integer)] [LRECL(integer)] [CAPS] [ASIS] [BLOCK (integer)] [BLKSIZE (integer)] [LINE (integer)] [LRECL (integer)] [CAPS] [ASIS]</pre>
---------------------------	---

Subcommands of EDIT

<pre>ALLOCATE*</pre>	
<pre>{ BOTTOM } { B }</pre>	

OS/VS2 TSO Commands

Subcommands of EDIT (contd.)

{CHANGE} {C }	[* line-number-1[line-number-2] *[count 1] {string1 [string2[ALL]]} {count2 }
{COPY} {CO }	[line1 [line2] [line3] [INCR(lines)] *] { 'string' } [count] [line4] [INCR(lines)] *] [1] [*]
{DELETE} {DEL }	[* line-number-1[line-number-2] *[count]]
DOWN	[count] <i>Default: 1</i>
END	[SAVE NOSAVE]
EXEC*	
{FIND} {F }	string <i>Start comparison at this [position] column in each line</i>
HELP*	
{INPUT} {I }	[line-number[increment]] *] [R] [I] [PROMPT NOPROMPT]
{INSERT} {IN }	[insert-data]

*For description of function and syntax, refer to command of same name.

OS/VS2 TSO Commands

Subcommands of EDIT (contd.)

Insert/ Replace/ Delete	{line-number} [string] * }
{LIST} {L}	[line-number-1[line-number-2]] [*[count]] [NUM] [SNUM]
{MOVE} {MO}	{ line1 [line2] [line3] [INCR(lines)] } * - { 'string' [count] [line4] [INCR(lines)] } * - 1 - }
PROFILE*	
{RENUM} {REN}	[new-line-no.[increment[old-line-no.[end-line-no.]]] <i>Default: 10</i>
{RUN} {R}	['parameters'] <i>100 char max; if used, enter first</i> [TEST NOTEST] [LMSG SMSG] [LPREC SPREC] [CHECK OPT] [LIB(data-set-list)] [STORE NOSTORE] <i>VSBASIC only</i> [GO NOGO] <i>1-999; SIZE is for VSBASIC only</i> [SIZE(value)] [PAUSE NOPAUSE] <i>VSBASIC only</i>

OS/VS2 TSO Commands

Subcommands of EDIT (contd.)

{SAVE} {S}	[{ * } {RENUM} {data-set-name} {REN } [{(new-line-num [incr [old-line-num [end-line-num]]]) }]]] Default = 10 {UNNUM} {UNN }
{SCAN} {SC }	[line-number-1 [line-number-2] * [count] [ON] [OFF]
SEND*	
{SUBMIT} {SUB }	{ (*) } {NOTIFY {data-set-list} {NONOTIFY }
{TABSET} {TAB }	[ON [(integer-list)] OFF IMAGE]
TOP	
{UNNUM} {UNN }	
UP	[count] Default: 1
{VERIFY} {V }	[ON] [OFF]
END	

*For description of function and syntax, refer to command of same name.

OS/VS2 TSO Commands

<p>{EXEC} {EX }</p> <p>or</p> <p>{%} proc.-</p>	<p>data-set-name</p> <p>['value-list']</p> <p>[NOLIST LIST]</p> <p>[NOPROMPT PROMPT]</p> <p>[value-list] name</p>
<p>FREE</p>	<p>{ DSNAME(data-set-name-list) DATASET(data-set-name-list) DDNAME(file-name-list) FILE(file-name-list) ATTRLIST(attr-list-names) }</p> <p><i>Choose one or more</i></p> <p>[[DEST(userid)] [SYSOUT(class)] [HOLD [SYSOUT(class)] NOHOLD] [KEEP DELETE SYSOUT(class) CATALOG UNCATALOG]]</p> <p><i>Choose only one, if any</i></p>
<p>{HELP} {H }</p>	<p>(sub)command-name [[FUNCTION] [SYNTAX] [OPERANDS{(list)}] [ALL] [MSGID(list)]]]</p> <p><i>VS BASIC only</i></p>

OS/VS2 TSO Commands

LINK	<p>(data-set-list)</p> <p>[LOAD[(data-set-name)]]</p> <p>[PRINT ({ * { data-set-name })]</p> <p>[NOPRINT]</p> <p>[LIB(data-set-list)]</p> <p>[PLILIB] [REFR] [TEST]</p> <p>[PLICMIX] [NOREFR] [NOTEST]</p> <p>[PLIBASE] [SCTR] [TERM]</p> <p> [NOSCTR] [NOTERM]</p> <p>[FORTLIB]</p> <p>[COBLIB] [OVLY] [DCBS(blocksize)]</p> <p> [NOOVLY]</p> <p>[MAP] [RENT]</p> <p>[NOMAP] [NORENT]</p> <p>[NCAL] [SIZE(integer1 integer2)]</p> <p>[NONCAL]</p> <p>[LIST] [NE]</p> <p>[NOLIST] [NONE]</p> <p>[LET] [OL]</p> <p>[NOLET] [NOOL]</p> <p>[XCAL] [DC]</p> <p>[NOXCAL] [NODC]</p> <p>[XREF] [HIAR]</p> <p>[NOXREF] [NOHIAR]</p> <p>[REUS] [AC (authorization-code)]</p> <p>[NOREUS]</p> <p style="text-align: right;">0-255</p>
{LISTALC} {LISTA }	<p>[STATUS]</p> <p>[HISTORY]</p> <p>[MEMBERS]</p> <p>[SYSNAMES]</p>

OS/VS2 TSO Commands

<pre>{LISTCAT} {LISTC }</pre>	<pre>[CATALOG(catname[/password])] [OUTFILE(ddname)] [OFILE(ddname)] [ENTRIES(entryname[/password] [...])] {LEVEL(level)} {LVL(level)} [CLUSTER] [DATA] [INDEX] IX [SPACE] SPC [NONVSAM] NVSAM [USERCATALOG] UCAT [GENERATIONDATAGROUP] GDG [PAGESPACE] PGSPC [ALIAS] [CREATION(days)] [EXPIRATION(days)] [ALL NAME VOLUME ALLOCATION HISTORY]</pre>
<pre>{LISTDS} {LISTD }</pre>	<pre>(data-set-list) [STATUS] [HISTORY] [MEMBERS] [LABEL] [CATALOG(cat-name)] [LEVEL]</pre>

OS/VS2 TSO Commands

{LOADGO} {LOAD }	(data-set-list) ['parameters'] [PRINT ({ * { data-set-name }) }] [NOPRINT] [LIB(data-set-list)] [PLILIB] [PLIBASE] [PLICMIX] [FORTLIB] [COBLIB] [TERM] [NOTERM] [RES] [NORES] [MAP] [NOMAP] [CALL] [NOCALL] [LET] [NOLET] [SIZE(integer)] [EP(entry-name)] [NAME(program-name)]
LOGOFF	[DISCONNECT] [HOLD]
LOGON	user-identity[/password] [ACCT(account)] [PROC(procedure)] [SIZE(integer)] [NOTICES] [NONOTICES] [MAIL] [NOMAIL] [PERFORM(value)] [RECONNECT]

OS/VS2 TSO Commands

{OUTPUT} {OUT }	(jobname[(jobid)] -list)
	[CLASS(classname-list)]
	[PRINT [(dsname)]] [BEGIN [HERE [NEXT]]] [PAUSE [NOPAUSE]]
	[KEEP [HOLD [NOHOLD]]] [NOKEEP]
	[DELETE]
	[NEWCLASS(classname)] [DEST(remote-station-id)]
	[HOLD [NOHOLD]]

Subcommands of OUTPUT

{CONTINUE} {C }	[BEGIN [HERE [NEXT]]] [PAUSE [NOPAUSE]]
END	
HELP*	
{SAVE} {S }	data-set-name

*For description of function and syntax, refer to command of same name.

OS/VS2 TSO Commands

<p>{ PROFILE } { PROF }</p>	<p>[CHAR ({ character }) ({ BS })] [NOCHAR]</p> <p>[LINE ({ ATTN }) ({ character }) ({ CTLX })] [NOLINE]</p> <p>[PROMPT] [NOPROMPT]</p> <p>[PREFIX(dsname-prefix)] [NOPREFIX]</p>	<p>[INTERCOM] [NOINTERCOM]</p> <p>[PAUSE] [NOPAUSE]</p> <p>[MSGID] [NOMSGID]</p> <p>[MODE] [NOMODE]</p> <p>[LIST]</p> <p>[WTPMSG] [NOWTPMSG]</p>
<p>{ PROTECT } { PROT }</p>	<p>data-set-name</p> <p>[ADD (password 2) REPLACE (password 1 password 2) DELETE (password 1) LIST (password 1)]</p> <p>[PWREAD] [NOPWREAD]</p> <p>[PWRITE] [NOWRITE]</p> <p>[DATA('string')]</p>	
<p>{ RENAME } { REN }</p>	<p>old-name new-name</p> <p>[ALIAS]</p>	

OS/VS2 TSO Commands

<pre>{RUN} {R }</pre>	<pre>data-set-name 100 char max ['parameters'] [ASM[LIB(data-set-list)] COBOL[LIB(data-set-list)] FORT[LIB(data-set-list)] PLI [CHECK] [LIB(data-set-list)] [OPT] IPLI [TEST] [LMSG] [NOTEST] [SMSG] BASIC [TEST] [LMSG] [LPREC] [NOTEST] [SMSG] [SPREC] GOFORT [FIXED] [LMSG] [FREE] [SMSG] VSBASIC [LPREC] [TEST] [GO] [SPREC] [NOTEST] [NOGO] [PAUSE] [SOURCE] [STORE] [NOPAUSE] [OBJECT] [NOSTORE] [SIZE (value)]]</pre>
<pre>{SEND} {SE }</pre>	<pre>'text' 115 char max (incl blanks) [[USER ({userid-list}) [NOW] [NOWAIT] [LOGON] [WAIT] [SAVE]] [OPERATOR(2) OPERATOR(route-code)] [CN(console-id)] Integer 0-64]</pre>
<pre>{STATUS} {ST }</pre>	<pre>[(jobname[(jobid)]-list)] 1-8 alphameric char</pre>
<pre>{SUBMIT} {SUB }</pre>	<pre>[data-set-list] [NOTIFY] [NONOTIFY]</pre>

OS/VS2 TSO Commands

{TERMINAL} {TERM }	[LINES(integer)] [NOLINES] [SECONDS(integer)] [NOSECONDS] [INPUT(string)] [NOINPUT] [BREAK] [NOBREAK] [TIMEOUT] [NOTIMEOUT] [LINESIZE(integer)] [CLEAR(string)] [NOCLEAR] [SCRSIZE(rows, length)]
TEST	[data-set-name] ['parameters'] [LOAD] [OBJECT] [CP] [NOCP]

Subcommands of TEST

AT	{ address[:address] } { (address-list) } [(subcommands-list)] [COUNT(integer)] [NODEFER] [DEFER] [NOTIFY] [NONOTIFY]
CALL	address [PARM(address-list)] [VL] [RETURN(address)]

OS/VS2 TSO Commands

Subcommands of TEST (contd.)

{COPY} {C }	address 1 address 2 [LENGTH (integer)] <u>4</u> [POINTER] [NOPOINT]
{DELETE} {DEL }	load-name <i>8 char max</i>
DROP	(symbol-list)
END	
{EQUATE} {EQ }	symbol address data-type [LENGTH(integer)] [MULTIPLE(integer)]
{FREEMAIN} {FREE }	integer address [SP (integer)] <u>0</u>
{GETMAIN} {GET }	integer [SP (integer)] <u>0</u> [EQUATE(name)]
GO	[address]
HELP*	
{LIST} {L }	{ address[:address] } data-type { (address-list) } [LENGTH(integer)] [MULTIPLE(integer)] [PRINT(data-set-name)]
LISTDCB	address [FIELD(names)] [PRINT(data-set-name)]

*For description of function and syntax, refer to command of same name.

OS/VS2 TSO Commands

Subcommands of TEST (contd.)

LISTDEB	address [FIELD(names)] [PRINT(data-set-name)]
LISTMAP	[PRINT(data-set-name)]
LISTPSW	[ADDR(address)] [PRINT(data-set-name)]
LISTTCB	[ADDR(address)] [FIELD(names)] [PRINT(data-set-name)]
LOAD	program-name
OFF	[address[:address]] [address-list]
{QUALIFY} {Q}	{address load-module-name[.entryname] [TCB(address)]}
{RUN} {R}	[address]
{WHERE} {W}	{address load-module-name[.entryname] [.offset]}

TIME	
WHEN	[SYSRC(operator integer)] [END command-name]

VM/370 Commands

*Source: GX20-1926-5 IBM Virtual Machine Facility/370
Quick Guide for Users
 GC20-1806-7 IBM Virtual Machine Facility/370
Operator's Guide Release 3 PLC 8*

Command outlines for CP and CMS commands are shown.

CP commands are divided into eight classes, A to G, by type of user. Classes A, B, and D designate operator commands; Class G, commands for general users.

CP commands that apply to the Real Machine are followed by (R), those that apply to the Virtual Machine (V).

Certain commands can be truncated. CP commands that can be, have the truncated version in uppercase (capital letters). The option is yours: you may enter commands in lower- or upper-case, using either the long or truncated version.

At the conclusion of the CP command outlines, there follow the command outlines of the most frequently used CMS commands. The complete set of CMS command outlines may be found in either of the sources cited above.

CP Operator Commands

ACNT (R)

CP Class A

Creates accounting records.

ACNT	{userid1 userid2 . . .} {ALL}
------	----------------------------------

ADSTOP (V)

CP Class G

Halts the virtual machine's execution.

ADSTOP	{hexloc} {OFF}
--------	-------------------

ATTACH (R)

CP Class B

Attaches a real device to a specified user or to the system.

ATTach	raddr [To] {userid [As] vaddr [R [/o]]} {SYSTEM [As] volid}
--------	---

ATTACH CHANNEL (R)

CP Class B

Attaches a channel to a designated user.

ATTach	CHANnel c [To] userid
--------	-----------------------

ATTENTION

CP Class G

ATTN	
------	--

CP Operator Commands

BACKSPAC (R)

CP Class D

Restarts a current spool file.

Printer Format

Backspac	raddr	[File] pages 1
----------	-------	------------------------

Punch Format

Backspac	raddr	[File]
----------	-------	----------

BEGIN (V)

CP Class G

Starts the execution of a virtual machine.

Begin	[hexloc]
-------	----------

CHANGE (R,V)

CP Classes D,G

Alters the attributes of a closed spool file.

CHange	[userid] [SYSTEM]									
	<table border="0"> <tr> <td rowspan="2"> <table border="0"> <tr> <td>Reader</td> <td>{ CLASS c1 spoolid ALL }</td> <td rowspan="2">CLASS c2</td> </tr> <tr> <td>Printer PUunch</td> <td>{ CLASS c1 spoolid ALL }</td> </tr> </table> </td> <td> <table border="0"> <tr> <td>{ CLASS c2 COpy nn [HOLD NOHold] Dist distcode [SYS NOSYS]</td> <td rowspan="2">}</td> </tr> <tr> <td></td> </tr> </table> </td> </tr> </table>	<table border="0"> <tr> <td>Reader</td> <td>{ CLASS c1 spoolid ALL }</td> <td rowspan="2">CLASS c2</td> </tr> <tr> <td>Printer PUunch</td> <td>{ CLASS c1 spoolid ALL }</td> </tr> </table>	Reader	{ CLASS c1 spoolid ALL }	CLASS c2	Printer PUunch	{ CLASS c1 spoolid ALL }	<table border="0"> <tr> <td>{ CLASS c2 COpy nn [HOLD NOHold] Dist distcode [SYS NOSYS]</td> <td rowspan="2">}</td> </tr> <tr> <td></td> </tr> </table>	{ CLASS c2 COpy nn [HOLD NOHold] Dist distcode [SYS NOSYS]	}
<table border="0"> <tr> <td>Reader</td> <td>{ CLASS c1 spoolid ALL }</td> <td rowspan="2">CLASS c2</td> </tr> <tr> <td>Printer PUunch</td> <td>{ CLASS c1 spoolid ALL }</td> </tr> </table>	Reader		{ CLASS c1 spoolid ALL }	CLASS c2		Printer PUunch	{ CLASS c1 spoolid ALL }	<table border="0"> <tr> <td>{ CLASS c2 COpy nn [HOLD NOHold] Dist distcode [SYS NOSYS]</td> <td rowspan="2">}</td> </tr> <tr> <td></td> </tr> </table>	{ CLASS c2 COpy nn [HOLD NOHold] Dist distcode [SYS NOSYS]	
	Reader	{ CLASS c1 spoolid ALL }	CLASS c2							
Printer PUunch	{ CLASS c1 spoolid ALL }									
{ CLASS c2 COpy nn [HOLD NOHold] Dist distcode [SYS NOSYS]	}									
		[NAME {fn [ft]} dsname}								

CP Operator Commands

CLOSE (V)

CP Class G

Terminates spooling operations on a virtual reader, printer, or punch.

CLOse	Reader vaddr CONsole Printer PUnc vaddr	[HOId NOHold]	[PURge [D1st distcode] [HOId NOHold] [NAme {fn [ft]} {dsname}]]

CP

CP Any Class

Allows any virtual machine operator to execute a CP console function from a virtual console read without first having to press the "attention" key to get to the CP console function environment.

#CP	[commandline1 [#commandline2 . . .]]
-----	---------------------------------------

The example that follows shows how #CP is used:

Command	System Action
#CP	User enters CP environment
#CP query files	QUERY command executed
#CP query files#query users	QUERY command execution twice
data entered ␣ #CP msg op is tape available	MSG command executed
#CP data entered	CP environment is entered and invalid command line is read
data entered ␣ #CP	CP environment entered
#CP query files ␣ data entered	QUERY is not executed; invalid command line entered in CMS environment

CP Operator Commands

COUPLE

CP Class G

Use to connect your virtual (non-dedicated) channel-to-channel adapter to another user's virtual channel-to-channel adapter (or to another one of your own virtual channel-to-channel adapters).

```
COUPLE vaddr1 [To] userid vaddr2
```

DCP

CP Class E

Displays the contents of real storage locations at the terminal.

DCP	[Lhexloc1 Thexloc1 hexloc1 0]	[{ - } :]	[hexloc2 END]
		[{ . }]	[bytcount END]

DEFINE (V)

CP Class G

Reconfigures the user's virtual machine.

DEFine	Reader Printer FUnch [As] vaddr CONSOLE CTCa TIMer 1403 3211 CHANnels [As] { SEL } { BMX } Line [As] vaddr [TEL[E2]] [IBM[1]] vaddr1 [As] vaddr2 GRAF cuu [3270] [3158] T2305 T2314 T2319 [As] vaddr [CYL] nnn T3330 T3340 T3350 STORage [As] { nnnnK } { nnM }
--------	---

CP Operator Commands

DETACH (R)

CP Class B

Removes a real device from the CP system.

DETach	raddr [From] {userid SYSTEM}
--------	---------------------------------

DETACH (V)

CP Class G

Detaches a virtual device from the virtual machine.

DETach	{vaddr CHANnel c}
--------	----------------------

DETACH CHANNEL (R)

CP Class B

Removes the specified channel and all its related devices from the specified user.

DETach	CHANnel c [From] userid
--------	-------------------------

DIAL (V)

CP Class ALL

Attaches a terminal device to a multiple access system.

Dial	userid [vaddr]
------	----------------

DISABLE (R)

CP Classes A,B

Inhibits the use of communication lines.

DISAble	{raddr . . .} ALL }
---------	------------------------

DISCONN (V)

CP Class ALL

Disconnects the terminal from virtual machine operation.

DISConn	[HOLD]
---------	--------

CP Operator Commands

DISPLAY (V)

CP Class G

Displays storage locations and registers within the virtual machine.

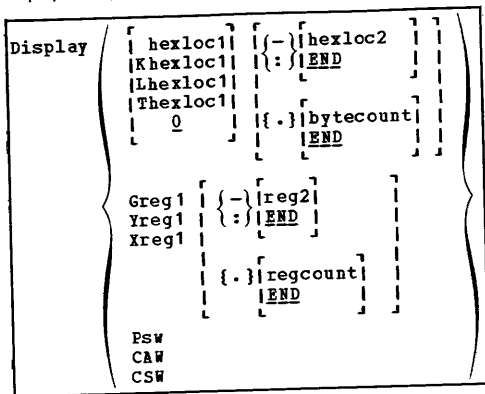

DMCP

CP Class E

Prints the contents of real storage locations on the user's virtual spooled printer.

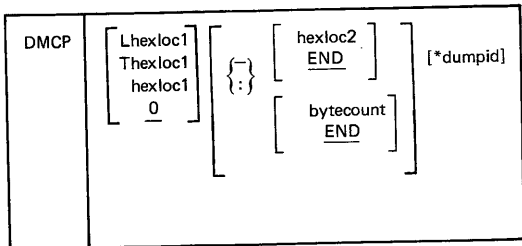

CP Operator Commands

DRAIN (R)

CP Class D

Stops spooling activity on the specific device after the current file is finished spooling.

DRain	[Reader Printer PUnch raddr . . . <u>ALL</u>]
-------	---

DUMP (V)

CP Class G

Dumps virtual machine registers and storage to the virtual printer.

DUMP	{ [Lhexloc1 Thexloc1 hexloc1 <u>0</u>] { - } [hexloc2] : } [<u>END</u>] . } [bytecount] [<u>END</u>] } [*dumpid]
------	---

ECHO (V)

CP Class G

Returns data directly to the terminal.

ECho	[nn <u>1</u>]
------	--------------------------

ENABLE (R)

CP Classes A,B

Activates communication lines.

ENable	{ raddr . . . } <u>ALL</u>
--------	----------------------------------

EXTERNAL (V)

CP Class G

Creates an external interrupt condition on the virtual machine.

EXTernal	[code <u>40</u>]
----------	-----------------------------

CP Operator Commands

FLUSH (R)

CP Class D

Halts and immediately purges or holds the current spool file.

FLush	raddr	[ALL]	[HOLD]
-------	-------	-------	--------

FORCE (R)

CP Class A

Forces logout of the named user.

FORCE	userid
-------	--------

FREE (R)

CP Class D

Releases previously held user spool files.

Free	userid	[Printer] [PUnch] [ALL]
------	--------	-------------------------------

HALT (R)

CP Class A

Stops any active channel program on the real device specified.

HALT	raddr
------	-------

HOLD (R)

CP Class D

Defers processing of specified spool output.

HOLD	userid	[Printer] [PUnch] [ALL]
------	--------	-------------------------------

IPL (V)

CP Class G

Initiates a program load on the virtual machine.

Ipl	{ vaddr [cyl-no] [CLear NOCLear] [STOP] }	[PARM {p1 p2...}]
-----	--	-------------------

CP Operator Commands

LINK (V)

CP Class G

Permits one user to access mini-disks belonging to another user.

LINK	[To] userid vaddr1 [As] vaddr2 [mode] [[PASS=] password]
------	---

LOADBUF (R)

CP Class D

LOADBUF	raddr { UCS name [Fold] [Ver] } { FCB name [Index [nn]] }
---------	--

LOADVFCB (V)

CP Class G

Loads a forms control image for a virtual 3211 printer.

LOADVFCB	vaddr FCB name [Index [nn]]
----------	-----------------------------

LOCATE

CP Class E

Finds the addresses of CP control blocks associated with a particular user, a user's virtual device, or a real system device.

LOCate	{ userid [vaddr] } { raddr }
--------	---------------------------------

LOCK (V)

CP Class A

Locks specified pages in processor storage.

LOCK	{ userid } firstpage lastpage [MAP] { SYSTEM }
------	---

LOGOFF (V)

CP Class ALL

Terminates a terminal session.

LOGout LOGoff	[HOld]
------------------	--------

CP Operator Commands

LOGON (V)

Initiates all virtual machine operation.

Logon	userid [password] [Mask] [Noipl]
-------	----------------------------------

MONITOR (R)

CP Classes A,E

Initiates or terminates the recording of events that occur in the real machine.

MONitor	DISplay { PERform RESPonse SCHEDULE }
	ENable { USER INSTsim DAStap SEEKS }
	{ SYSprof }
	INTERval nnnnn [<u>SEC</u> MIN]
START { CPTRACE }	
{ TAPE raddr }	
{ [MODE{ 800 1600 6250}] }	
STOP { CPTRACE }	
{ TAPE }	

MESSAGE (V)

CP Classes A,B

Sends text messages to other users or the system operator.

Message MSG	{ ALL userid * OPERator }	msgtext
----------------	------------------------------------	---------

Message MSG	{ userid * OPERator }	msgtext
----------------	-----------------------------	---------

CP Operator Commands

NETWORK

CP Classes A and B

Provides controls for utilizing and controlling 3705 and its resources. Also provides a means of altering binary synchronous line poll delay interval.

NETWORK	<pre> LOAD raddr ncpname DUMP raddr [IMMED OFF AUTO] ENable [ALL resources...] DISABLE [ALL resources...] Query [OFFline FREe ALL resources... ACTive] Display raddr hexloc1 { - } { hexloc2 } : { END } { bytcount } { END } SHUTDOWN [ALL raddr] POLLdelay nnnn [ALL raddr] VARY {ONline OFFline EP NCP} [resources...] </pre>
NETWORK	TRACE {BTU raddr resource END}

NETWORK

CP Class F

Network	TRACE {BTU raddr resource END}
---------	------------------------------------

NOTREADY (V)

CP Class G

Simulates the loss of ready status on a virtual spooled unit record device.

NOTReady	vaddr
----------	-------

ORDER (R.V)

CP Class D

Provides a technique for ordering closed spool files.

Order	<pre> [userid] {Reader} {Class c1 Class c2 ...} [SYSTEM] {Printer} {spoolid1 spoolid2 ...} {PUnch} </pre>
-------	---

PURGE (R.V)

CP Class G

Deletes a spooled file before reading, printing, or punching occurs.

PURge	[userid SYSTEM]	{ Reader Printer PUnc ALL	[{Class c1 Class c2 ... } {spoolid1 spoolid2 ... } <u>ALL</u>
--------------	--------------------	------------------------------------	--

QUERY (R.V)

CP Classes A and B

Provides the paging activity index or specified user priority or the Virtual Machine Assist feature.

Query	{ PAGing PRIORity userid } { SASsist
--------------	--

QUERY (R)

CP Class B

Provides the current status of all system devices.

Query	{ { DAsd TApes LINES UR GRaf ALL } [ACTive OFFline FREe ATTach ALL] } { DAsd volid TDSK STORAGE raddr SYStem raddr DUMP }
--------------	---

CP Operator Commands

QUERY (V)

CP Class G

Provides the virtual machine user with the current status of his virtual machine, spooling devices and spool files.

Query	Time Set TERMinal Files [Class c]																														
	[Virtual] <table style="display: inline-table; vertical-align: middle; border: none;"> <tr><td style="font-size: 2em;">{</td><td>CHANnels</td><td style="font-size: 2em;">}</td></tr> <tr><td></td><td>GRaf</td><td></td></tr> <tr><td></td><td>CONsole</td><td></td></tr> <tr><td></td><td>DAsd</td><td></td></tr> <tr><td></td><td>TAPes</td><td></td></tr> <tr><td></td><td>LINES</td><td></td></tr> <tr><td></td><td>UR</td><td></td></tr> <tr><td></td><td>STORage</td><td></td></tr> <tr><td></td><td>ALL</td><td></td></tr> <tr><td></td><td>vaddr</td><td></td></tr> </table>	{	CHANnels	}		GRaf			CONsole			DAsd			TAPes			LINES			UR			STORage			ALL			vaddr	
{	CHANnels	}																													
	GRaf																														
	CONsole																														
	DAsd																														
	TAPes																														
	LINES																														
	UR																														
	STORage																														
	ALL																														
	vaddr																														
	Links vaddr																														
	Reader [spoolid]																														
	Printer [ALL]																														
	PUnch [Class c]																														
	PF [nn]																														

QUERY (V)

CP Class ALL

Provides the remaining portion of the log message, and the names and real address of the logged on users.

Query	{ LOGmsg Names Users [userid] userid }
-------	---

CP Operator Commands

QUERY

CP Class D

Provides data on spooling information

Query	{ Files [CClass a] [userid] Reader Printer [ALL] [userid] PUnch [CClass a] spoolid HOId
-------	---

READY (V)

CP Class G

Makes a device end interrupt pending for the specified virtual device.

READY	vaddr
-------	-------

REPEAT (R)

Increases the copies of, or holds, an output spool file.

REPeat	raddr [[nn] [1] [nn] HOId]
--------	--------------------------------------

REQUEST

CP Class G

Use to make an attention interrupt pending at your virtual console.

REQuest	
---------	--

RESET (V)

CP Class G

Clears all pending interrupts and resets error conditions on the device specified.

RESET	vaddr
-------	-------

CP Operator Commands

REWIND (V)

CP Class G

Rewinds a real tape drive.

REWIND	vaddr
--------	-------

SAVESYS

CP Class E

Save a virtual machine storage space with registers and PSW as they currently exist.

SAVESYS	systemname
---------	------------

SET (R)

CP Class A

Sets special CP preferred options.

Set	}	FAVored	userid	[xx OFF]	}
		REServe	userid	{xx OFF}	
		SASsist		{ON OFF}	
		PRIORity	userid	nn	

SET (R)

CP Class B

Establishes disposition for log messages and dumps.

Set	}	LOGmsg	{nn NULL}	}
		DUmp	{AUTO raddr}	

CP Operator Commands

SET (V)

CP Class G

Sets virtual machine options.

Set	ACNT	}	}	
	MSG			
	WNG			ON
	IMSG			OFF
	RUN			
	LINEdit			
	NOTrans			
	ECmode			
	ISAM			
	PAGEX			
	EMSG { ON OFF CODE TEXT }			
	TIMER { <u>ON</u> OFF REAL }			
	ASSist { OFF [ON][SVC NOSVC] }			
PFnn [IMMed <u>DE</u> layed][pfddata#...]				
PFnn [TAB n1 n2...nn]				
PFnn COPY [resid cuu]				

SHUTDOWN (R)

CP Class A

Checkpoints and terminates the current VM/370 operation.

SHUTDOWN	
----------	--

SLEEP (V)

CP Class ALL

Places the virtual machine in a dormant state with the terminal keyboard locked.

Sleep	[nn [SEC <u>MIN</u> HRs]]
-------	---------------------------------

CP Operator Commands

SPACE (R)

CP Class D

Forces single spacing on the printer.

SPace	raddr
-------	-------

SPOOL (V)

CP Class G

Changes spooling control options.

SPool	{ Reader } { vaddr }	[<u>Class T</u>] [CONT] [CLOSE]
		[<u>Class { * c }</u>] [<u>NOCONT</u>] [PURGE]
	{ EOF } [HOLD]	[<u>NOEOF</u>] [<u>NOHOLD</u>]
	{ Printer } { PUnch } { vaddr }	[<u>To</u>] [<u>userid</u>] [<u>Hold</u>]
		[<u>For</u>] [*] [<u>NOHold</u>]
	[] [SYSTEM] []	
	[OFF] [<u>Class A</u>]	
	[] [<u>Class c</u>] []	
	[CONT] [<u>COPY nn</u>] [CLOSE]	
	[<u>NOCont</u>] [<u>COPY 01</u>] [PURGE]	
{ CONsole } { vaddr }	[<u>STArT</u>] [<u>HOld</u>] [CONT]	
	[<u>STOp</u>] [<u>NOHold</u>] [<u>NOCont</u>]	
	[<u>To</u>] [<u>userid</u>] [<u>Class T</u>]	
	[OFF] [<u>Class c</u>] []	
	[<u>TErm</u>] [<u>COPY nn</u>] [CLOSE]	
	[<u>NOTerm</u>] [<u>COPY 01</u>] [PURGE]	

CP Operator Commands

START (R)

CP Class D

Restarts a drained device or changes its output spooling class.

STArt	{ Reader Printer PUnch <u>ALL</u> [raddr, [Class c] [NOsep]] . . .
-------	--

STCP

CP Class C

Alters the contents of real storage.

STCP	{ { hexloc } hexword1 [hexword2. . .] { Lhexloc } Shexloc hexdata
------	--

STORE (V)

CP Class G

Alters virtual machine storage, PSW, and registers.

STore	{ hexloc Lhexloc hexword1 [hexword2 . . .] Shexloc hexdata . . . { Greg } { Yreg } hexword1 [hexword2 . . .] { Xreg } Psw [hexword1] hexword2 STATUS
-------	--

SYSTEM (V)

CP Class G

Simulates virtual machine console functions.

SYStem	{ CLEAR RESET RESTART
--------	--------------------------------

CP Operator Commands

TAG

CP Class G

Use the TAG command to associate information with a VM/370 spool file, usually for use with a subsystem such as RSCS or a user-written subsystem.

TAG	DEV	{ Printer PUunch CONsole vaddr }	[text]
	FILE	spoolid	[text]
	QUERY	{ DEV { Printer PUunch CONsole vaddr } FILE spoolid }	

TERMINAL (V)

CP Class G

Changes parameters for terminal operations.

TERMINAL	CHardel	{ ON }	}
	LINEDel	{ OFF }	
	LINENd	{ char }	
	EScape		
	Mask	{ ON }	
	APL	{ OFF }	
	ATTn		
MODE	{ CP } { VM }	}	
LINESize	nnn		

CP Operator Commands

TRACE (V)

CP Class G

Traces and records program execution.

TRace	{ <ul style="list-style-type: none"> SVC I/O PROgram EXTernal PRIV SIO CCW BRanch INSTRUCT ALL CSW END 	[<ul style="list-style-type: none"> Printer [BOTH] [RUN] [TERMinal] [NORun] Off]
-------	--	--

TRANSFER (R.V)

CP Class D

Transfers command to direct an input spool file to a specified user's virtual spool input, or to reclaim input spool files that originated from the specified user.

TRANSfer	[userid] {spoolid} [To] {userid} [SYSTEM] {Class c} [FROM] {ALL} {ALL}
----------	--

UNLOCK (R)

CP Class A

Releases storage.

UNLOCK	{ {userid} firstpage lastpage {SYSTEM} } VIRT=REAL
--------	--

CP Operator Commands

VARY (R)

CP Class B

Varies the availability of a device.

VARY	{ONline} {OFFline}	raddr. . .
------	-----------------------	------------

WARNING (R)

CP Classes A,B

Transmits high priority messages to a specified user or to all users.

Warning WNG	{userid OPerator ALL }	msgtext
----------------	------------------------------	---------

ASTERISK

CP Class ALL

Use * to annotate the console sheet with a comment.

*	anycomment
---	------------

CMS Command Formats

Source: GC20-1806-5

Invoking the Batch Facility

CMS

The Batch Facility virtual machine is invoked by the batch operator when he issues the CP IPL command followed by the CMSBATCH command. This sequence takes the form:

```
ipl cms
CMS mm/dd/yy WED 17.58.48
cmsbatch
Y/S (19E) R/O.
THE FOLLOWING NAMES ARE UNDEFINED:
  BATEXIT1 BATEXIT2
R; T=0.14/0.39 08:47:40
WAITING FOR THE READER
```

The operator may now disconnect the batch machine terminal, if he wishes, using the CP DISCONN command. The Batch Facility will IPL itself after each job is executed.

CMS Command Formats

COPYFILE

Copies files according to operand specifications.

COPYfile	fileid1 [fileid2. . .] [(options)]
----------	--

COPYfile	fileid1 [fileid2...] [fileido] [(options...[])]
<u>options:</u>	
[<u>Type</u>]	[<u>OLDDate</u>] [<u>RECfm F</u>] [<u>NOPrompt</u>] [<u>TRANS</u>]
[<u>NOType</u>]	[<u>NEWDate</u>] [<u>RECfm V</u>] [<u>Prompt</u>]
[<u>UPcase</u>]	[<u>FRom recno</u>] [<u>FOR recno</u>]
[<u>LOWcase</u>]	[<u>PRLabel xxxxxxxx</u>] [<u>TOLabel xxxxxxxx</u>]
[<u>REPlace</u>]	[<u>Fill c</u>] [<u>TRUnc</u>] [<u>PACK</u>] [<u>EBcdic</u>]
[<u>OVly</u>]	[<u>Fill hh</u>] [<u>NCTRunC</u>] [<u>UNPack</u>]
[<u>APPend</u>]	[<u>Fill 40</u>]
[<u>NEWFile</u>]	[<u>LRecl nn</u>] [<u>SPecs</u>]
	[<u>NOSpecs</u>]
COUPLE vaddr1 [To] userid vaddr2	
CP [commandline]	

DDR

CMS

INVOKING DDR UNDER CMS

DDR	[filename [filetype [filemode]] *]
-----	---

INVOKING DDR AS A STANDALONE PROGRAM

To use DDR as a standalone program, the operator should IPL it from a real or virtual IPL device as he would any other standalone program. Then indicate where the DDR program is to obtain its control statements by responding to prompting messages at the console.

CMS Command Formats

DIRECT

To build a user directory on a system-owned volume using preallocated cylinders.

DIRECT	[fn [ft [fm *]]] [(EDIT[])]
--------	------------------------------

If running under VM/370, a normal completion results in the newly created directory being dynamically swapped, and placed in use by VM/370 (providing the user's class is A, B or C and the directory volume is present in the system owned LIST). In either case the directory is updated on the directory volume.

EDIT

CMS

Provides access to the EDIT environment

EDIT	filename filetype [filemode [LRECL nnn NODISP]]
------	---

Subcommand

Usage

ALter char1 char2 [n * G *]]	Scans records, altering the specified character.
AUTOSave [n OFF]	Saves the file after the indicated number of changes.
BACKward [n]	Repositions the current line pointer backward.
Bottom	Moves the current line pointer to the last line of the file.
CASE [U M]	Translates to uppercase.
Change [/string1 [/string2 [/ n G]]]	Changes string1 to string2.

CMS Command Formats

EDIT (Contd.)

Subcommand	Usage
CMS	Enters CMS subset command mode.
DELEte [n 1 *]	Deletes <u>n</u> lines or to EOF.
DOWN [n 1]	Moves the current line pointer to the <u>n</u> th line down from the current line.
DString /[string[/]]	Deletes lines from the current line to (but not the line that including) contains the designated string.
FILE [fn [ft [fm]]]	Saves the file edited on disk and returns to CMS mode.
Find [line]	Searches the file for the specified line.
FMode [fm]	Resets or displays the filemode.
FName [fn]	Resets or displays the filename.
FORMat {DISPLAY LINE}	Changes the mode of displaying data on a 3270 terminal from typewriter style to display style or vice versa.
FORward [_ n]	Moves the current line pointer forward <u>n</u> lines.
Getfile fn [ft [fm [m [n]]]] [* [* [1 [* []]]]]	Inserts some or all of the specified file.

CMS Command Formats

EDIT (Contd.)

Subcommand

Usage

- IMAGE**
[ON|OFF|CANON] Expands text into line images or displays current settings.
- Input** [line] Inserts 'line' in the file or enters input mode.
- LINEmode**
[Left|Right|OFF] Sets or displays the line numbering mode.
- [Locate] /[string[/] Scans the file for the first occurrence of 'string'.
- LONG** Enters LONG error message mode.
- Next** [n|1] Points to the nth line down from the current line.
- Overlay** [line] Replaces all or part of the current line.
- PREserve** Saves current mode settings.
- PROMPT** [n|10] Sets the line increment.
- QUIT** Terminates the EDIT session.
- RECFm** [F|V] Sets or displays record format.
- RENum** [strtno|10 [incrno|strtno]] Recomputes line numbers.
- REPEAT** [n|1]* Executes the following OVERLAY request n times.
- Replace** [line] Replaces the current line with 'line' or deletes the line and enters input mode.
- REStore** Restores mode settings.
- RETURN** Returns to EDIT environment.

CMS Command Formats

EDIT (Contd.)

Subcommand	Usage
{ REUSE } { = }	[edit subcommand] Stacks (LIFO) the last EDIT subcommand.
SAVE [fn [ft [fm]]]	Saves the file on disk.
{ Scroll S[croll]U[p] }	{ * n 1 } Displays a number of lines above or below the current line.
SERIAL	Turns serialization
{ [ON ALL seq [incr 10]] OFF }	on or off in columns 73-80.
SHORT	Enters SHORT error message mode.
STACK [n 1 0 edit subcommand]	Stacks <u>n</u> lines in the terminal input buffer.
TABSet n1 [n2 ... nn]	Sets the given tabs.
TOP	Moves the current line pointer to the beginning of the file.
TRUNC [n *]	Sets or displays the column of truncation.
Type [_ # * [n *]]	Displays the specified number of lines beginning with the current line.
Up [n 1]	Points to the line <u>n</u> lines above the current line.
Verify [ON OFF] [[startcol 1] endcol *]	Sets, displays, or resets verify mode.
{X Y} [edit subcommand n 1]	Assigns to X or Y the given EDIT subcommand.

CMS Command Formats

EDIT (Contd.)

Subcommand

Usage

Zone [m|*|1 [n|*]] Sets or displays the columns to be edited.

? Displays the last EDIT subcommand.

nnnnn [text] Locates the line.

\$DUP [1|n] Duplicates the current line.

\$MOVE n {Up m|Down m|To label} Moves n lines up or down m lines.

FORMAT

CMS

Formats a disk for use by CMS.

FORMAT	cuu mode [nocyl] [(options...)]
options:	
[LABEL]	
[RECOMP]	
[]	

LISTFILE

CMS

Lists information about CMS files

Listfile	[[fn [ft [fm]]] [(options)]]
----------	--

options:

[Header|NOHeader] [EXec|APpend]

[FName|FType|FMode|FFormat|ALloc|Date|Label]

CMS Command Formats

MOVEFILE

CMS

Moves data from one device to another device.

MOVEfile	[inputddname <u>INMOVE</u>]	[outputddname <u>OUTMOVE</u>]	option: [PDS []]
----------	---------------------------------	-----------------------------------	-----------------------

NCPDUMP

Processes CP spool reader files created by 3705 dumping operations.

NCPDUMP	[DUMPxx] [([ERASE][NOFORM][MNEMONIC] [])]]
---------	---

PRINT

CMS

Directs a specified spool file to the virtual printer.

PRint	fn ft [fm *] [(options...[])]
<u>options:</u>	
[CC]	[MEMBER { * }] [UPCASE] [HEX]
[NOCC]	[{ name }] [LINECOUN [nn 55]]

PUNCH

CMS

Directs a specified spool file to the virtual punch.

PUCh	fn ft [fm] [HEADER *] [NOHEADER] [MEMBER { * membername }]
------	---

CMS Command Formats

QUERY

CMS

Permits the user to obtain specified information about his virtual machine's CMS functions.

Query	<pre> BLIP RDYMSG LDRTBLS RELPAGE INMCP IMPEX ABBREV REDTYPE PROTECT SEARCH DISK { mode } * { SYSTEM } SYNONYM { USER } { ALL } FILEDEF MACLIB TXTLIB LIBRARY INPUT OUTPUT SYSNAMES DLBL DOS DOSLIB DOSPART OPTION UPSI </pre>
-------	--

READCARD

CMS

Reads data from the spooled card input device.

READcard	<pre> (fn ft [fm]) * [* [* [fm]]] [A] [A] </pre>
----------	--

CMS Command Formats

SET

CMS

Control various functions within your virtual machine. (Only one function may be specified per SET command.)

SET	<pre> [BLIP string[(count)]][INPUT [a xx]] [BLIP ON][[xx yy]] [BLIP OFF][] [[PROTECT OFF] [<u>PROTECT ON</u>] [[LDRTBLS nn] [OUTPUT [xx a]] [[RDYMSG SMSG][RELPAGE OFF][ABBREV OFF] [<u>RDYMSG LMSG</u>][<u>RELPAGE ON</u>][<u>ABBREV ON</u>] [[IMPEX OFF][IMPCP OFF][REDTYPE OFF] [<u>IMPEX ON</u>][<u>IMPCP ON</u>][<u>REDTYPE ON</u>] [[AUTOREAD ON] [AUTOREAD OFF] [[SYSNAME { CMSDOS { CMSVSAM } entryname { CMSAMS { CMSSEG } [[NONSHARE { CMSDOS { CMSVSAM { CMSAMS { CMSSEG [[DOS ON [mode[(VSAM[)]]][UPSI nnnnnnnn] [<u>DOS OFF</u>][<u>UPSI OFF</u>] [[DOSPART nnnnnK] [<u>DOSPART OFF</u>] [</pre>
-----	---

CMS Command Formats

TAPE

CMS

Performs tape to disk or disk to tape operations for CMS data sets.

TAPE	<pre> DUMP {fn! } {ft! } [fm] [(optA optB optC)] { * } { * } { * } LOAD [fn [ft [fm]]] [(optA optB optC)] [*] [*] [A] SCAN [fn [ft]] [(optA optB optC)] [*] [*] SKIP {fn! } {ft! } [(optA optB optC)] { * } { * } MODEset [(optD)] tapcmd [n] [(optD)] [1] optA: [WTM] [optB: [NOPrint] optC: [EOF n] [NOWTM] [PRint] [EOT] [DISK] [EOF 1] [TERM] optionD: [[[TAPi] [cuu]] [TRTCH {O OC OT E ET}] [7TRACK] [[[TAP1] [181]] [9TRACK] [[[] []] [] tapcmd: [BSF BSR ERG FSF FSR REW RUN WTM] </pre>
------	---

TAPPDS

CMS

Loads an OS partitioned data set (PDS) file or card-image records from tape to disk.

TAPPDS	<pre> [fn [ft [fm]]] [(options...)] [*] [*] [A] options: [PDS] [COL1] [TAPn] [END] [MAXTEN] [NOPDS] [NOCOL1] [TAP1] [NOEND] [NOMAXTEN] [UPDATE] </pre>
--------	---

CMS Command Formats

UPDATE

CMS

Makes changes in file as defined by control cards in a record file.

Update	fn1 [ft1 [<u>ASSEMBLE</u>]] [fm1 [fn2 [ft2 [fm2]]]] [(options... [])]
--------	--

options:					
[REP NOREP]	[SEQ8 NOSEQ8]	[INC NOINC]	[CTL NOCTL]	[STK NOSTK]	
[TERM NOTERM]	[DISK PRINT]	[STOR NOSTOR]			

VMFDUMP

Formats and prints, or erases, an existing dump.

VMFDUMP	[DUMPxx]	[ERASE]
	[PRBnnnnn]	[NCMAP]
		[NOHEX]
		[NOFORM]
		[NOVIRT]

ZAP

CMS

This command (though intended primarily for the system programmer) could allow the system operator to access 3704/3705 LOADLIB members, find a precise point within the program, verify the authenticity of that location, and then modify the contents to modify that program.

ZAP	{ MODULE LOADLIB TXTLIB }	[libname1 ... libname3]
		[(options... [])]
options:		
[TERM]	[PRINT]	
[INPUT filename]	[NOPRINT]	

IPL PROCEDURE FOR DOS/VS WITH THE DOC

Source: GC33-5378 Operator's Library
DOS/VS Operating Procedures
Release 33

1. Perform the power on and load microprogram procedures as described in the appropriate hardware manual and wait until PROGRAM LOAD appears on the screen.
2. Mount the SYSRES disk pack on a disk drive and ready this device.
3. Mount the pack containing the page data set on the disk drive assigned to SYSVIS. (If the standard assignment for SYSVIS does not exist or is not to be used, any disk drive can be chosen for the pack; the physical address of the drive must then be specified in the DPD command.) If the page data set resides on a 3340 Disk Storage, this device must be ready before you start the IPL procedure.
4. Type in the physical device address of the disk drive that holds the SYSRES disk pack.
5. Type in character C in order to clear storage. Only if during a hard wait you want to draw a stand-alone dump type in N instead to conserve storage contents.

If you do not want to use any emulation press ENTER.

If you are using 2311, or 2314 emulation (only with Model 125) specify the number of buffers needed.

If you want 1052 emulation (only if your supervisor is not generated for a Model 115 or 125) move the cursor to the emulator prompting message and specify E. Then press ENTER.

6. When WAIT appears on the screen, press REQUEST. This displays the following message:

```
0I03A SPECIFY SUPERVISOR NAME
```

If you wish to use the default supervisor (\$\$\$\$SUP1), press ENTER; otherwise, enter the name of the required supervisor and then press ENTER.

7. When WAIT appears on the screen again, press REQUEST. The system will respond with the following information message identifying the SYSRES file and CPU:

```
0I04I IPLDEV=devaddr,VOLSERNO=volserno,  
CPUID=CPU-id
```

One of the following sets of messages will then be displayed:

- A. 0I30I DATE=date,CLOCK=time,ZONE=difference
0I10A GIVE IPL COMMANDS
- B. 0I31A DATE REQUIRED, CLOCK REQUIRED,
ZONE=difference
0I10A GIVE IPL COMMANDS

IPL PROCEDURE FOR DOS/VS WITH THE DOC

- C. 0I32I TOD CLOCK INOPERATIVE; NO TOD SUPPORT
0I31A DATE REQUIRED, CLOCK REQUIRED
0I10A GIVE IPL COMMANDS
8. Depending on the messages that were printed on SYSLOG (see step 6), take the following action:
- A. 1. If all values are satisfactory, enter the SET command without parameters.
2. If the date or time of day is not satisfactory, enter the SET command with both DATE and CLOCK parameters, and press TOD CLK.
3. If the zone is not satisfactory, enter the SET command with the ZONE parameter.
4. If none of the values is satisfactory, enter the SET command with all parameters and press TOD CLK.
- B. 1. If the zone value is satisfactory, enter the SET command with DATE and CLOCK parameters, and press TOD CLK.
2. If the zone value is not satisfactory, enter the SET command with all parameters and press TOD CLK.
- C. If the message is 0I31A, then take the same action as in B above.
9. Enter the CAT command, if required, to indicate on which physical device the disk pack containing the VSAM catalog is mounted.
10. Enter the DPD command to define the page data set. DPD is mandatory; all operands are optional.
11. Press ENTER. The system then issues the message

```
0I20I IPL COMPLETE FOR DOS/VS REL xx.x ECLEVEL=nn
```

in which case you can go to steps 11 and 12 or it issues the messages

```
0I20I IPL COMPLETE FOR DOS/VS REL xx.x ECLEVEL=nn  
1T00A WARM START COPY OF SVA FOUND
```

There are three possible responses:

- A. Enter KEEP and press ENTER if you wish to keep the current copy of the SVA (Shared Virtual Area); in this case, steps 11 and 12 cannot be executed.
- B. Press ENTER. This has the same effect as A, above.
- C. Enter REJ and press ENTER if you do not wish to keep the current copy of the SVA; in this case you can go to steps 11 and 12.

IPL PROCEDURE FOR DOS/VS WITH THE DOC

12. If you wish to change the size of the existing SVA, enter the SET SVA=(nK,nK) job control command.

13. If you wish to use one of the standard SDLs provided by IBM, do one of the following:

a. If you do not need VSAM modules, enter the command

EXEC PROC=SDL

b. If you need VSAM modules, enter the command

EXEC PROC=VSAMSV

This procedure creates a system directory list of the VSAM modules, in addition to those phases otherwise entered by the procedure SDL. It also loads these VSAM modules into the SVA.

<p>Does your system use RDE? If so, turn to Procedure 6.</p>
--

Display Operating Console - Models 115 and 125 - Commands

Sources: GC33-5378 DOS/VS Operating Procedures, Release 33

Examples of the K Command

Note: The K command is used in conjunction with Models 115 and 125 only.

First Operand	Second Operand	Meaning	Example	Explanation of Example
S	,REF	Display current values of the S-operands	K S,REF *	Assuming that the initialization values are still in effect, K S,DEL=Y,CON=Y, SEG=6 is displayed in the entry area.
S	,DEL=Y	Delete messages automatically	K S,DEL=Y	When the screen is full, all deletable messages are deleted.
S	,DEL=N	Do not delete messages automatically	K S,DEL=N	When the screen is full, use the K command or the cursor to delete messages.
S	,CON=Y	Delete messages after verification	K S,CON=Y	When a deletion command has been entered, you can check the messages before they are deleted.
S	,CON=N	Delete messages immediately	K S,CON=N	When a deletion command has been entered, messages are deleted immediately.
S	,ALM=Y	Activate audible alarm	K S,ALM=Y	An alarm will sound if you enter an incorrect control (K) command, or when the message 'MESSAGE WAITING' is displayed.
S	,ALM=N	De-activate audible alarm	K S,ALM=N	The audible alarm will not warn you if you enter an incorrect control (K) command, or when the message 'MESSAGE WAITING' is displayed.
S	,SEG=n	Delete n lines at a time	K SEG=4	When you enter K E,SEG (or just K), lines 1 through 4 are deleted.

* You may also enter K S since REF is the default value of the S operand.

Display Operating Console - Models 115 and 125 - Commands

Examples of the K Command (cont'd)

First Operand	Second Operand	Meaning	Example	Explanation of Example
E	,SEG	Delete message lines as specified in S SEG=n	K E,SEG**	Assuming S,SEG=5 was specified, lines 1 through 5 are deleted.
E	,n	Delete line n	K E,4	Message line 4 is deleted.
E	,n,n	Delete the range of lines from n to n	K E,2,6	Lines 2 through 6 are deleted.
E	,N	Delete the line numbers	K E,N	The message line numbers are deleted from the screen.
D	,N	Display line numbers in all message lines	K D,N	All message lines, including continuation lines, are numbered until a K E command is issued.
D	,N,HOLD	Prevents line numbers from being deleted	K D,N,HOLD	All message lines are numbered. Line numbers are erased only by K E,N command.

** You may also enter K since E and SEG are default values.

Display Operating Console - Models 115 and 125 - Commands

Examples of the K Command

Note: The D command is used in conjunction with Models 115 and 125 only.

Entering redisplay mode

Command	Meaning
D	} Enter redisplay mode for all messages
D L	
D L,ALL	
D L,AR	Enter redisplay mode for AR messages only
D L,BG	Enter redisplay mode for BG messages only
D L,Fx	Enter redisplay mode for messages from a specified foreground partition only

Controlling redisplay operation

Command	Meaning
D L,ALL	Redisplay all messages
D L,F2	Redisplay messages from F2 only
D L,F4,R	Reset the screen to the most recent F4 messages
D L,B	Change from forward to backward redisplay
D L,F	Change from backward to forward redisplay
D L,F,240	Space forward 240 lines
D L,B,70	Space backward 70 lines
D L,B	Reset the screen to status when redisplay started
D L,170	Space 170 lines forward or backward, depending on the redisplay direction currently in effect

Terminating redisplay mode

Command	Meaning
D E	Terminate redisplay mode

IPL PROCEDURE FOR OS/VS1

Sample IPL VS1 Release 6

```
IEA760A SPECIFY VIRTUAL STORAGE SIZE
(default)
IEA761I PAGE=(V=PAGPAK,CYL=140)
IEE054I DATE=75.177,CLOCK=11.24.44
IEE054I DATE=75,177,CLOCK=11.24.22,GMT
IEA764I NIP0001,CMD00001,DFN00001,JESPARMS,,PRESRES,,SET00001,SMFPRM00,
IEA765I DEVSTAT=ALL
IEA101A SPECIFY SYSTEM AND/OR SET PARAMETERS FOR RELEASE 06.0 OS/VS1
(default)
IEA103I DATASET SYS1.DUMP NOT FOUND BY LOCATE
IEA135A SPECIFY SYS1.DUMP TAPE UNIT ADDRESS OR NO
(default)
IEA208I SYS1.DUMP FUNCTION INOPERATIVE
IEA106I IEAAPF00 NOT FOUND IN SYS1.PARMLIB
IEE140I SYSTEM CONSOLES
  CONSOLE/ALT COND AUTH ID ROUTCD
  01F/01F M ALL 01 1-10,12-16
IEF032I PARMLIB VALUES TAKEN FOR JES
IEE866I DEFINE COMMAND BEING PROCESSED
IEE805I DEFINITION COMPLETED
IEE101A READY
IEE029I Q=(,F),SWPRM=(U),JLPRM=(100,20,25)
IEF249I FOLLOWING P/R AND RSV VOLUMES ARE MOUNTED
PAGPAK ON 130 (P/R-PRV)
231400 ON 131 (RSV-STR)
231401 ON 133 (RSV-STR)
LNK145 ON 136 (P/R-PRV)
VS1445 ON 137 (P/R-PRV)
IBE052I VARY (00C,00E),ONLINE
IEE009I LOG NOW RECORDING ON DATA SET X
IEE302I 00C ONLINE
IEE302I 00E ONLINE
IEE052I MN JOBNAME,T
IEE052I START RDR,00C
IEE052I START WTR,00E,,A
IEE052I START INIT.ALL
IEE354I SMF PARAMETERS
  SID=155A
  OPI=YES
  JWT=010
  BUF=2000
  MAN=ALL
  EXT=YES
  OPT=2
00 IEE357A REPLY WITH SMF VALUES OR U
R 0,u
R 0,U
IEE360I SMF NOW RECORDING ON SYS1.MANX ON 136. TIME=11.30.07
IEE048I INITIALIZATION COMPLETED
```

IPL PROCEDURE FOR OS/VS2 JES2

Sample IPL VS2 JES2 Release 3.7

```
IEA101A SPECIFY SYSTEM PARAMETERS FOR RELEASE 03.70 VS2
r00,sysp=26,clpa
IEA851I FOLLOWING MAY BE MOUNTED
SPLIT2 ON 3330
IEA851A REPLY DEVICE ADDRESSES OR U

IEF165I // START JES2
IEE712I TRACE PROCESSING COMPLETE
*00 IFB010D ENTER 'IPL REASON,SUBSYSTEM ID' OR 'U'
IEF354I SMF PARAMETERS
IEE354I SID=H155
IEE354I JWT=10
IEE354I BUF=2000
IEE354I MAN=NONE
IEE354I EXT=YES
IEE354I OPT=2
IEE354I OPI=YES
*01 IEE357A REPLY WITH SMF VALUES OR U
>
r 1,jwt=200,ext=no
IEE600I REPLY TO 01 IS;JWT=200,EXT=NO
IEE351I SMF SYS1.MAN RECORDING NOT BEING USED
*02 $HASP426 SPECIFY OPTIONS - HASP-II, VERSION JES2 3.7
>
r 2,cold,noreg,haspparm=normal1
IEE600I REPLY TO 02 IS;SUPPRESSED

IEE041I THE SYSTEM LOG IS NOW ACTIVE

$HASP160 PRINTER1 INACTIVE - CLASS=AFS13579
$HASP100 INIT ON STCINRDR
$HASP100 INIT ON STCINRDR
$HASP309 INIT 1 INACTIVE ***** C=ACHQSX
$HASP309 INIT 2 INACTIVE ***** C=ACHQSX
$HASP099 ALL AVAILABLE FUNCTIONS COMPLETE
```

Formula for Computing Day of Year for Set Date Parameter (ddd)

Formula: $ddd = ((m-1) 30) + t + a$

where m = month number

t = day of month

a = adjustment for month (see table)

Ex: March 15, 1977 ADJUSTMENT TABLE (see Note)

	Month	m	a	month	m	a
ddd=((3-1)30)+15+(-1) =2x30+15-1 =74	Jan.	1	0	July	7	1
	Feb.	2	1	Aug.	8	2
	Mar.	3	-1	Sept.	9	3
	Apr.	4	0	Oct.	10	3
	May	5	0	Nov.	11	4
	June	6	1	Dec.	12	4

NOTE: For Leap Year add 1 to ddd AFTER Feb. 29.

IPL PROCEDURE FOR OS/VS2 JES3

Sample IPL VS2 JES3 Release 3.7

IEAI01A SPECIFY SYSTEM PARAMETERS FOR RELEASE 03.7A.VS2

IEA876I SYS1.DUMP00 EMPTY

IEA877A SPECIFY FULL DASD SYS1.DUMP DATASETS TO BE EMPTIED,
TAPE UNITS TO BE USED AS SYS1.DUMP OR GO

IEF165I // START JES3

v 004,offline

IEE712I TRACE PROCESSING COMPLETE

*00 IFB010D ENTER 'IPL REASON, SUBSYSTEM ID' OR 'U'

r 0,u

IEE351I SMF SYS1.MAN RECORDING NOT BEING USED

IEE600I REPLY TO 00 IS;U

IEC161I 056-084,MSTR,MSTRMSTR,STGINDEX,,,SYS1.STGINDEX,

IEC161I T5C10998.VSAMDSSET.DFD76273.T89AAD19.T5C10998,
SYS1.MVSCAT37

IEC161I 056-084,MSTR,MSTRMSTR,STGINDEX,,,SYS1.STGINDEX,

IEC161I T5C13778.VSAMDSSET.DFD76273.T89AAD19.T5C13778,
SYS1.MVSCAT37

IEF403I JES3 - STARTED - TIME=18.34.21

IEF281I 004 NOW OFFLINE

IEF236I ALLOC. FOR JES3 JES3

IEF237I 00F ALLOCATED TO JES3OUT

IEF237I 00F ALLOCATED TO JES3SNAP

IEF237I 00F ALLOCATED TO SYSABEND

IEF237I 00F ALLOCATED TO JESABEND

IAT3040 STATUS OF JES3 PROCESSORS IN COMPLEX

r 1,c

IAT3040 SY1 <UP>, SY2 ()

IEE600I REPLY TO 01 IS;C

*01 IAT3011 SPECIFY JES3 START TYPE (L H W WA OR C)

*02 IAT3033 CONFIRM JES3 COLDSTART REQUEST (U)

r 2,u

IEE600I REPLY TO 02 IS;U

*03 IAT3012 SELECT JES3 INISH ORIGIN (N M= OR U=), AND OPTIONAL
EXIT PARM (,P=)

r 3,u=00c

IEE600I REPLY TO 03 IS;U=00C

IEF236I ALLOC. FOR JES3 JES3

IEF237I 00C ALLOCATED TO JES300C

*04 IEC123D 00F, SPECIFY UCS PARAMETER

r 4,tn

IEE600I REPLY TO 04 IS;TN

IEE349I HARDCOPY CONSOLE

CONSOLE/ALT COND AUTH ID ROUTCD

SYSLOG H CMDS ALL

1836430 ERR IAT7120 I/O ERROR ON CN10

STATUS-0200 SENSE-10 OP-05

1836431 ERR CN1 *IAT7110 CN10 INACTIVE - PERM. ERROR

1836434 ERR CN1 IAT7140 CN10 SWITCHED TO CN1

IPL PROCEDURE FOR OS/VS2 JES3

Sample IPL VS2 JES3 Release 3.7 (Cont'd)

```

1836597 ALL IAT3100 JES3 2.0.0 SYSTEM COLDSTART
ON 76.281 AS SY1
1837030 MLG DUMMY IAT7100 (MAIN ) *F G,SYA1,CHK
1837031 DUMMY +F G,SYA1,CHK
8f 0 d=on
1837033 MLG DUMMY IAT7100 (MAIN ) *F G,SY01,CHK
1837033 DUMMY +F G,SY01,CHK
1837033 MLG DUMMY IAT7170 '*F G,SY01,C' REQUEST ENQUEUED
1837035 MLG DUMMY IAT7100 (MAIN ) *F G,SY02,CHK
8f 0 m=off
1837035 DUMMY +F G,SY02,CHK
1837035 MLG DUMMY IAT7170 '*F G,SY02,C' REQUEST ENQUEUED
1837037 MLG DUMMY IAT7100 (MAIN ) *F G,MVT,CHK
1837037 DUMMY +F G,MVT,CHK
1837037 MLG DUMMY IAT7170 '*F G,MVT,CH' REQUEST ENQUEUED
1837039 MLG DUMMY IAT7100 (MAIN ) *F G,SVS,CHK
1837040 DUMMY +F G,SVS,CHK
1837040 MLG DUMMY IAT7170 '*F G,SVS,CH' REQUEST ENQUEUED
1837135 CN1 +F O D=ON
1837135 CN1 IAT7170 '*F O D=ON ' REQUEST ENQUEUED
8s jss
1837157 CN1 IAT8020 DLOG FACILITY ENABLED
1837272 CN1 +F O M=OFF
183727 IAT8020 MLOG FACILITY DISABLED
183742 IAT6300 JES3 FUNCTIONS COMPLETE
8x cr
183808 IAT6300 JES3 FUNCTIONS COMPLETE
183808 IAT6306 JOB 0001 IS CR , CALLED BY CN1
183810 IAT2645 ***** SY1 CONNECT COMPLETE *****
183814 IAT6101 JOB 0002 IS INITJES3, PRTY=15
183815 IAT6101 JOB 0003 IS SYSLOG , PRTY=15
183826 *SY1= JES3 IEA000A 00C,INT REQ,02,0200,4030500000,,
JES3

```

OS/VS Display Consoles

Sources: GC38-0260 OS/VS2 Display Consoles
GC38-0255 OS/VS1 Display Consoles

The CONTROL command (abbreviated K) controls the display console. Each function of this command is described in an appropriate place in the SRL. To request a summary of the CONTROL command operands and the functions that they perform, enter the following commands:

$$\left\{ \begin{array}{c} \text{DISPLAY} \\ \text{D} \end{array} \right\} \quad \text{C,K [,L= } \left\{ \begin{array}{c} \text{a} \\ \text{cc} \\ \text{cca} \end{array} \right\} \quad]$$

C,K specifies that a summary of CONTROL command operands is to be displayed.

L= $\left\{ \begin{array}{c} \text{a} \\ \text{cc} \\ \text{cca} \end{array} \right\}$ specifies the display area (a), console (cc), or both (cca) at which the display is to be presented. If you omit this operand, the display is presented in the first available display area on the console through which you entered the command; (unless routing instructions are in effect).

For example, to display a summary of CONTROL command operands in display area A of console 10, enter:

D C,K,L=10A

A printed summary of Control command formats appears in OS/VS2 (JES 2) commands summary which you will find in this section.

PROGRAM FUNCTION KEYS

Entering Commands with the PFKs

The program function keyboard is a group of 12 keys (called PFKs) located on the right side of the operator console keyboard. (It is an optional feature of the model 3277 display console, and is not available for the model 158 display console.) One or more PFKs may be available to you for entering commands. The PFKs are designated for operator command entry by the system programmer during system generation.

Each PFK is defined as conversational or nonconversational. The commands associated with a nonconversational PFK are entered immediately when you press the key. The commands associated with a conversational PFK are presented in the entry area, one at a time, when you press the key. You may make changes to them before you enter them.

In place of keys, the Mod 158 Display Console provides a PFK line (above the instruction line) and entering of commands by light pen.

How to Display the PFK Numbers

Use the following form of the CONTROL command to display and erase the numbers in the PFK display line:

$$\left\{ \begin{array}{c} \text{CONTROL} \\ \text{K} \end{array} \right\} \quad \left\{ \begin{array}{c} \text{D PFK} \\ \text{E PFK} \end{array} \right\}$$

D, PFK specifies that the numbers of the PFKs designated for command entry are to be displayed in the PFK display line.

E, PFK specifies that the numbers are to be erased from the PFK display line.

Example: To request display in the PFK display line (this line is located immediately above the instruction line), enter:

K D PFK

Section 5 Contents

Section: Input/Output Devices and Restart Procedures	5-1
Status Byte Summary	5-2
Sense Byte Summary	5-3
Card Readers: General Hints	5-11
2501 Card Reader	5-12
3504/3505 Stop Indications and Restart Procedures	5-14
3525 Stop Indications and Restart Procedures	5-20
OS/VS1 Checkpoint Restart	5-29
OS/VS2 Checkpoint Restart	5-30
3340 Disk Drive: Operating Hints	5-31
Console File S/370 Mod 125	5-33
Diskette	5-34
Operating Procedures	5-35
Cartridge Handling	5-36
3410/3411 Tape Drive	5-37
Operating Procedures after Failures	5-37
Cleaning Procedures	5-37
Tape Transport Cleaning	5-38
Tape Handling and Storage	5-39
3420 Tape Drive	5-40
Cleaning Procedures	5-40
Operating Procedures after Failures	5-40
Writing a Tape Mark	5-41
1403 Printer	5-42
3203 Printer	5-44
3211 Printer	5-47
Error Recovery Summary	5-47
Error Recovery Procedures	5-48
Video Display Screen Areas on:	
Mod 125	5-49
Mod 158	5-50
Mod 168	5-51
Operating the OS/VS Display Console (Mod 158)	5-52
Operating the 3270	5-54

Status Byte

Source: Component Description SRL for each device

	NOT USED	DE	DEVICE END	
ATTN	ATTENTION	SM	STATUS	MO
CE	CHANNEL END	UC	UNIT CHECK	
CUE	CONTROL UNIT END	UE	UNIT EXCEPTION	

DEVICE	BIT							
	0	1	2	3	4	5	6	7
1403				BUSY	CE	DE	UC	UE
2301 (2820)		SM	CUE	BUSY	CE	DE	UC	UE
2303	ATTN	SM	CUE	BUSY	CE	DE	UC	UE
2305(2835)	ATTN	SM	CUE	BUSY	CE	DE	UC	UE
2319		SM	CUE	BUSY	CE	DE	UC	UE
2400		SM	CUE	BUSY	CE	DE	UC	UE
2560				BUSY	CE	DE	UC	UE
2596				BUSY	CE	DE	UC	UE
2701	ATTN	SM		BUSY	CE	DE	UC	UE
2702		SM	CUE	BUSY	CE	DE	UC	UE
2703		SM	CUE	BUSY	CE	DE	UC	UE
2821				BUSY	CE	DE	UC	UE
3203				BUSY	CE	DE	UC	UE
3210	ATTN	SM		BUSY	CE	DE	UC	UE
3211				BUSY	CE	DE	UC	UE
3215	ATTN			BUSY	CE	DE	UC	UE
3270	ATTN	SM	CUE	BUSY	CE	DE	UC	UE
3277	ATTN			BUSY	CE	DE	UC	
3330		SM		BUSY	CE	DE	UC	UE
3340		SM	CUE	BUSY	CE	DE	UC	UE
3410			CUE	BUSY	CE	DE	UC	UE
3411			CUE	BUSY	CE	DE	UC	UE
3420(3803)		SM	CUE	BUSY	CE	DE	UC	UE
3504				BUSY	CE	DE	UC	UE
3525				BUSY	CE	DE	UC	UE
3540				BUSY	CE	DE	UC	
3704	ATTN	SM	CUE	BUSY	CE	DE	UC	UE
3705	ATTN	SM	CUE	BUSY	CE	DE	UC	UE
5203				BUSY	CE	DE	UC	UE
5213	ATTN	SM	CUE	BUSY	CE	DE	UC	UE
5425				BUSY	CE	DE	UC	UE

Status Byte

Source: GA26-1635 Reference Manual for the IBM 3800 Printing Subsystem
GA32-0029 IBM 3850 Mass Storage System (MSS), Principles of Operation

Bit	0	1	2	3	4	5	6	7
3800 Pr.	ATTN	SM	CUE	BUSY	CE	DE	UC	UE
3850 MSS	ATTN	SM	CUE	BUSY	CE	DE	UC	UE

Sense Bytes

Sense Bytes--IBM 3800 Printing Subsystem
Byte 0

Bit	0	1	2	3	4	5	6	7
3800 Pr.	CMD REJ	INT REQ	BUS OUT	EQ CHK	DATA CHK	RE-SER-VED	LOAD CHK	CHAN. 9

For bytes 1 through 23, see GA26-1635 Reference Manual. If intervention is required (byte 0 bit 1 on), examine sense bytes 1 through 4. If there is a jam, examine sense bytes 20 and 21, which will tell you how many pages got lost in the buffer and what to do (GA26-1635-0, page 69).

Sense Bytes--IBM 3850 Mass Storage System (MSS)
Bytes 0-3

Bit	0	1	2	3	4	5	6	7
IBM 3851								
Byte 0	CMD REJ	INT REQ	BUS OUT	EQ CHK	NOT USED	HOST RETRY	NOT USED	ENVIR. DATA
Byte 1	CE MESS.	UNIT UN-USABLE	HOST CHAN ID		SSID CHARACTER 0			
Byte 2		SSID CHARACTER 1			SSID CHARACTER 2			
Byte 3	FOR-MAT 0	FOR-MAT 1	FOR-MAT 2	FOR-MAT 3	FOR-MAT 4	FOR-MAT 5	UN-SUC-CESS-FUL TRY	SUC-CESS-FUL TRY

See GA32-0029 MSS Principles of Operation for bytes 4-31 which differ depending on the format.

Sense Bytes

Sources: SY33-8571 DOS/VS Handbook, Release 31

GA22-6895 (2301 only)... GA26-5988 (2303 only)...

GA26-1589 (2305 only)... GA33-1506 (3203 only)...

GA26-1617 (3820 only)... GA21-9167 (5425 only)

Sense Bytes

Byte 0

DEVICE \ BIT	0	1	2	3	4	5	6	7
1017	CMD REJ	INT REQ	BUS OUT		DATA CHK			BRKN TAPE
1018	CMD REJ	INT REQ	BUS OUT	EQ CHK	DATA CHK			
1287	CMD REJ	INT REQ	BUS OUT	EQ CHK	DATA CHK	OVER-RUN	NON RCVY	KYBD CORR
1288	CMD REJ	INT REQ	BUS OUT	EQ CHK	DATA CHK	OVER-RUN	NON RCVY	
1403	CMD REJ	INT REQ	BUS OUT	EQ CHK	DATA CHK	STRPTY ERR		CH9
1443					TYPE BAR	TYPE BAR		
1442, 2501, 2520, 2596	CMD REJ	INT REQ	BUS OUT	EQ CHK	DATA CHK	OVER-RUN		
1419 PCU	CMD REJ	INT REQ	BUS OUT		DATA CHK	OVER-RUN	AUTO SELECT	
1419 SCU	CMD REJ	INT REQ	BUS OUT		DATA CHK	OVER-RUN	AUTO SELECT	
2260	CMD REJ	INT REQ	BUS OUT	EQ CHK				
2301/2820	CMD REJ	INT REQ	BUS OUT	EQ CHK	DATA CHK	OVER-RUN		
2305	CMD REJ	INT REQ	BUS OUT	EQ CHK	DATA CHK	OVER-RUN		
2311, 2321	CMD REJ	INT REQ	BUS OUT	EQ CHK	DATA CHK	OVER-RUN	TRK COND CHK	SEEK CHK
2314, 2319	CMD REJ	INT REQ	BUS OUT	EQ CHK	DATA CHK	OVER-RUN	TRK COND CHK	SEEK CHK
2400	CMD REJ	INT REQ	BUS OUT	EQ CHK	DATA CHK	OVER-RUN	WRT CNT ZERO	DATA CUNT CHK
2495	CMD REJ	INT REQ	BUS OUT	EQ CHK	DATA CHK	SHOULD NOT OCCUR	POSN CHK	SHOULD NOT OCCUR
2540	CMD REJ	INT REQ	BUS OUT	EQ CHK	DATA CHK		UN-USUAL CMD	
2560	CMD REJ	INT REQ		EQ CHK	DATA CHK	FEED/MACH CHK		NO CRD AVAIL
2671, 2822	CMD REJ	INT REQ	BUS OUT	EQ CHK	DATA CHK			
3203	CMD REJ	INT REQ		EQ CHK	DATA CHK	CHAINBUF PARITY CHK	NO CHANNEL FOUND	CHANNEL 9
3210, 3215	CMD REJ	INT REQ		EQ CHK				
3211	CMD REJ	INT REQ	BUS OUT	EQ CHK	DATA CHK	BUFFER PARITY CHK	LOAD CHK	CH9
3330	CMD REJ	INT REQ	BUS OUT	EQ CHK	DATA CHK	OVER-RUN		
3340	CMD REJ	INT REQ	BUS OUT	EQ CHK	DATA CHK	OVER-RUN	TRK COND CHK	SEEK CHK
3410, 3411	CMD REJ	INT REQ	BUS OUT	EQ CHK	DATA CHK	OVER-RUN	WRT CNT ZERO	DATA CUNT CHK
3420, 3803	CMD REJ	INT REQ	BUS OUT	EQ CHK	DATA CHK	OVER-RUN	WORD COUNT ZERO	DATA CUNT CHK
3504, 3505, 3525	CMD REJ	INT REQ	BUS OUT	EQ CHK	DATA CHK		ABN FORMAT RESET	PERM ERR (by pass key)
3540	CMD REJ	INT REQ	BUS OUT	EQ CHK	DATA CHK			
3881	CMD	INT	BUS	EQ			UN-USUAL CMD SQ	
3886	CMD REJ	INT REQ	BUS OUT	EQ CHK			NON-INIT	RCP ERR
5425	CMD REJ	INT REQ	BUS OUT	EQ CHK	DATA CHK		NO CARD AVAILABLE	

Sense Bytes

Byte 1

BIT DEVICE	0	1	2	3	4	5	6	7
1287	TAPE MODE	LATE STKR SELECT	NO DOC FOUND		INVAL OP			
1288		END OF PAGE	NO DOC FOUND		INVAL OP			
1419 SCU	FLD 6 VALID	FLD 7 VALID	DOC UNDER W HD	AMT FLD VALID	PRO CTL FLD VALID	ACCT# FLD VALID	TRANSIT FLD VALID	SER # FLD VALID
2260								
2301/2820	DATA CHK IN COUNT	TRK OVER- RUN	END OF CYL	INVAL SEQ	NO REC FOUND	FILE PROT	SVC OVER- RUN	OVER- FLOW INC
2305	PERM ERROR	INVAL TRK FORMAT	END OF CYCLE		NO REC FOUND	FILE PROT		OPER- ATION INC
2311, 2321	DATA CHK IN COUNT	TRK OVER- RUN	END OF CYL	INVAL SEQ	NO REC FOUND	FILE PROT	MISSING ADDR MARKER	OVER- FLOW INC
2314, 2319	DATA CHK IN COUNT	TRK OVER- FLOW	END OF CYL	INVAL SEQ	NO REC FOUND	FILE PROT	SERVICE OVER- RUN	OVER- FLOW INC
2400	NOISE	00-NON-XST TU 01-NOT READY 10-RDY&NO RWD 11-RDY & RWD		7 TRK	AT LOAD POINT	WRT STATUS	FILE PROT	TAPE IND
2560	COVER INT LCK	JAM BAR CHK	CORNER ST'N CHK	CELL 8/9 FDCHK	PRINT ST'N FDCHK	PUNCH ST'N FDCHK	READ ST'N FDCHK	INPUT ST'N FDCHK
3203	NOT USED							
3211	CMD RETRY	PRINT CHK	PRINT QUALITY	LINE POS	FORMS CHK	CMD SUP	MECHAN ICAL MOTION	
3330	PERM ERR	INVLD TRK FORMAT	END OF CYL		NO REC FOUND	FILE PROT	WRITE INHIBIT	OPER- ATION INC
3340	PERM ERR	INVLD TRK FORMAT	END OF CYL		NO REC FOUND	FILE PROT	WRITE INHIBIT	OPER- ATION INC
3410, 3411	NOISE	TU STAT A	TU STAT B	7 TRK	AT LOAD POINT	WRT STATUS	FILE PROT	NOT CAPA- BLE
3420, 2803	NOISE	TU STAT A	TU STAT B	7 TRK	AT LOAD POINT	WRT STATUS	FILE PROT	NOT CAPA- BLE
3504, 3505, 3525	PERM ERR	AUTO RETRY	MOTION MAL FUN	RETRY AFTER INT REQ COMPL				
3540	PERM ERR	AUTO RETRY	MOTION MAL FUN	RETRY AFTER INT REQ COMPL	SPEC RCRD XFRD			
3886		MARK CHK	INVLD FOR- MAT		SCAN INC		NON RCVY	OUT BRD
5425	READ CHK	PUNCH CHK		PRINT DATA CHK	PRINT CLUTCH CHK	HOP- PER CHK	FEED CHK	

Sense Bytes

Byte 2

BIT	0	1	2	3	4	5	6	7
DEVICE								
2260		BIT 15	BUFFER BIT 14	ADDRESS BIT 13	REGISTER BIT 12	BIT 11	BIT 10	BIT 9
2301/ 2820	UN-SAFE	SHIFT REG LOCK	SKEW	COUNTER CHK	COMP CHK			
2305	BUF LOG FULL	CORRECT-ABLE						
2311, 2321	UN-SAFE		SER/DESER		ALU CHK	UNSEL STATUS		
2314, 2319	UN-SAFE		SER/DESER	TAG LINE	ALU CHK	UNSEL STATUS		
2400	BITS 0-7 INDICATE A TRACK IS IN ERROR						6 & 7 INDICATE NO ERROR OR MULTI-ERROR	
3203	INTER-LOCK	FORM CHK	COIL PROT CHK	SUBSCAN RING CHK	CHAIN BUF ADDR REG CHK	HAMMER UNIT SHIFT CHK	ANY-HAMMER ON CHK	DEVICE READY CHK
2311, 2321	UN-SAFE		SER/DESER		ALU CHK	UNSEL STATUS		
2314, 2319	UN-SAFE		SER/DESER	TAG LINE	ALU CHK	UNSEL STATUS		
2400	BITS 0-7 INDICATE A TRACK IS IN ERROR						6 & 7 INDICATE NO ERROR OR MULTI-ERROR	
3211	CARR FAILED TO MOVE	CARR SEQ	CARR STOP	PLATEN FAILED	PLATEN FAILED	FORMS JAM	RIBBON MO-TION	TRAIN OVER-LOAD
3330		CORRECT-ABLE		ENV DATA PRESENT				
3340	RP5 FEATURE PRESENT	CORRECT-ABLE		ENV DATA PRESENT			DATA MODULE SIZE	
3410, 3411	TRACK IN ERROR BITS							
3420, 3803	TRACK IN ERROR BITS							
3504/5, 3525	USED FOR DIAGNOSTIC PURPOSES ONLY							
3540	USED FOR DIAGNOSTIC PURPOSES ONLY							
5425			CARD IN PRIMARY	CARD IN SECONDARY		HOPPER CYCLE INC	CARD IN TRANS-PORT BIT 2	CARD IN TRANS-PORT BIT 1

Sense Bytes

Byte 3

BIT	0	1	2	3	4	5	6	7
DEVICE	BUFFER ADDRESS REGISTER							
2260	BIT 8	BIT 7	BIT 6	BIT 5	BIT 4	BIT 3	BIT 2	BIT 1
2301/ 2820	LONG REDUND CHK							
2305	RESTART COMMAND							
2311	READY	ON LINE	UN- SAFE		ON LINE	END OF CYL		SEEK INC
2314	BUSY	ON LINE	UN- SAFE	WR CUR CFN	PACK CHNG	END OF CYL	M- MODE SE	SEEK INC
2319	LRC BIT 0	LRC BIT 1	LRC BIT 2	LRC BIT 3				
2321	DRIVE READY	DRIVE OPER	READ SAFETY	WRITE SAFETY	STRIP READY	INVL D ADDR	AUTO REST	CE CELL LOC
3205			CAR- RAGE INHIBIT CHK				STEP CHK	MOVE CHK
2400	R/W VRC	LRCR	SKEW	CRC	SKEW REQ	0-1600 1-800	BKWD STATUS	COM- PARE
3211	UCSB PARITY	PLB PARITY	FCB PARITY	COIL PROT CHK	HAM- MER FIRE	FIELD ENG	USCAR SYNC CHK	SEP SYNC CHK
3330	RESTART COMMAND							
3340	RESTART COMMAND							
3410, 3411	VRC	MTE/ LRCR	SKEW	END DATA CHK/CRC	ENV CHK	1600 BPI IN TU	BKWD	
3420 3803	R/W VRC	MTE/ LRC	SKEW	END DATA CHK/CRC	VRC/ ENV CHK	1600 BPI	BKWD	COM- PARE
3504/5, 3525	USED FOR DIAGNOSTIC PURPOSES ONLY							
3540	CYLINDER ADDRESS IN BINARY							
5425	FEED AND EMITTER CHECKS (HEX NO)							

Sense Bytes

Byte 4

BIT DEVICE	0	1	2	3	4	5	6	7
2260								
2301/2820	SEQ IND	SEQ IND	SEQ IND	SEQ IND	SEQ IND	SEQ IND	SEQ IND	SEQ IND
2305	UNUSED							
2311, 2321								
2314	PHYSICAL DRIVE IDENTIFICATION							
2319	SEQ IND 0	SEQ IND 1	SEQ IND 2	SEQ IND 3	SEQ IND 4	SEQ IND 5	SEQ IND 6	SEQ IND 7
2400	ECHO ERR	RES TAPE UNIT	READ CLOCK ERR	WRITE CLOCK ERR	DELAY CNTR	SEQ IND C	SEQ IND B	SEQ IND A
3203	HAM- MER RE- SET FAIL- URE CHK	NO FIRE CHK	MIS- FIRE CHK	PRINT DATA BUF PARITY CHK	CHK BIT BUF PARITY CHK	CHAIN BUF PARITY CHK	BUF ADDR REG CHK	CLOCK CHK
3211								
3330	STORAGE CONTROL ID		PHYSICAL DRIVE ID G=001110 E=011100 C=101010 A=111000 H=000111 F=010101 D=100011 B=110001					
3340	DRIVE IDENTIFICATION BIT DRIVE 0=A 2=C 4=E 6=G 1=B 3=D 5=F 7=H							
3410, 3411	TU POSIT CHK	TAPE IND				DIAG TRK CHK	TU CHK	ILLEGAL CMD
3420, 3803	ALU HDWR ERROR	REJ TAPE UNIT	TAPE INDI- CATE	WRITE TRGGR VRC	MICRO- PGM DET ERROR	LWR ERROR	TAPE UNIT CHK	RES RPQ
3540	HEAD ADDRESS , MUST BE BINARY ZERO							
5425	DEFINES CARD COLUMN GROUP AND TIER OF ERROR							

Sense Bytes

Byte 5

DEVICE	BIT 0	1	2	3	4	5	6	7
2260								
2301/2820								
2305	[DRIVE SEEK ADDRESS]							
2311, 2321	COMMAND IN PROGRESS WHEN OVERFLOW INCOMPLETE OCCURS							
2314	COMMAND IN PROGRESS WHEN OVERFLOW INCOMPLETE OCCURS							
2319								
2400	COMMAND IN PROGRESS WHEN OVERFLOW INC OCCURS OR ZERO							
3203	OPEN COIL CHK							
3211								
3330	CYLINDER ADDRESS (LOW)							
3340	CYLINDER ADDRESS (LOW)							
3410, 3411	NEW SUB- SYSTEM		WRT TM CHK	PE ID BURST	PRTY COMP	TACH CHK	FALSE END MARK	RPQ
3420, 3803	NEW SUB- SYSTEM	NEW SUB- SYSTEM	WRT TM CHK	PE ID BURST	START READ CHK	PARTIAL RECORD OR TM	XCESSVE PSTAMBL	RES RPQ
3540	RECORD ADDRESS IN BINARY							
5425	SPECIFIES ROW (S) FOR THE TIER OF ERROR							

Sense Bytes

Byte 6

DEVICE	BIT	0	1	2	3	4	5	6	7
2301/2820									
2305		[DRIVE SEEK ADDRESS]							
3203									
3330			CYL HIGH*		HEAD ADDRESS				
3340			CYL HIGH†	CYL HIGH		HEAD ADDRESS			
3410, 3411	7 TRK	SHRT GAP	DUAL DENSITY	ALT DENSITY	TAPE UNIT MODEL				
3420, 3803	7 TRK	WRT	DUAL	NRZI	TAPE UNIT MODEL DEFINED				
5425									

* 3330 - II CYL HIGH (512)

† 3340 CYL HIGH (512)

Byte 7

DEVICE	BIT	0	1	2	3	4	5	6	7	
2301/2820										
2305		[MESSAGE CODE (HEX)]								
3203										
3330*		FORMAT TYPE OF REMAINING SENSE BYTES (8-23)				ENCODED ERROR MESSAGE				
3340*		FORMAT TYPE OF REMAINING SENSE BYTES (8-23)				ENCODED ERROR MESSAGE				
3410, 3411	LAMP CHK	LEFT COL CHK	RT COL CHK	READY RESET	DATA SEC ERASE					
3420, 3803	LAMP FAIL	TAPE BOTTOM LEFT	TAPE BOTTOM RIGHT	RESET KEY	DATA SCRTRY ERASE	ERASE HEAD FAILED	AIR BRNG PRESS	LOAD FAIL		
5425										

Sense Bytes

Byte 8

BIT DEVICE	0	1	2	3	4	5	6	7
3330 *								
3340 *								
3410, 3411		FEED THRU		END VEL CHK	RD BK DATA NOT DET	START VEL CHK		
3420, 3803	IRG DROP IN WRT	FEED THRU CHK	SDR CNTR	EARLY BGN RD BK CHK	EARLY END RD BK CHK	SLOW BGN RD BK CHK	SLOW END RD BK CHK	VELOC RETRY/ RESTR

Byte 9

BIT DEVICE	0	1	2	3	4	5	6	7	
3420, 3803	JDR CNTR	VLCTY CHNG ON WRT	SDR COUNTERS						TAPE CTL RESD

Byte 10

BIT DEVICE	0	1	2	3	4	5	6	7
3420, 3803	CMD STATUS REJ		CNTRL STATUS REJ	NO BLK ON RCD RD BKCK	WTM NOT DETECT	TACH START FAIL		VELO- CITY CHK

Byte 11

BIT DEVICE	0	1	2	3	4	5	6	7
3420, 3803	B BUS PARITY ALU 1		LO ROS/ LO IC PARITY	HI IC BR COND /HI ROS	MCPGM DET HDWR ERR	D BUS PARITY ALU 1		BR COND ALU 1

Byte 12

BIT DEVICE	0	1	2	3	4	5	6	7
3420, 3803	B BUS PAR ERR ALU 2		LO ROS/ LO IC ON BR	HI IC BR/HI ROS REG	MCPGM DETECT HDWR ERR	D BUS PARITY ALU 2		BR COND ALU 2

* 3330/3340 Bytes 8 - 23: Meaning depends on format type.

Card Readers

CARD READERS – GENERAL HINTS

1. A common cause of read checks is off-punched or worn cards.
2. Use a card gauge to determine off-punching.
3. A validity check usually indicates a double punch in rows 1-7 of the card.
4. When bringing new cards into the computer room from a different environment (heat, humidity), do not use them for the first 12 hours.
5. Cards do wear out. Reproduce master decks when you notice excessive marking or scoring on the edges.
6. Some system sense messages that may be typed out on the console sheet and what to do about them are shown below:

Intervention Required - Operator attention is needed to empty the stacker, fill the hopper, clear the transport, close a cover, press END OF FILE, or restore ready status. This indication also accompanies a read station failure that occurs during reading.

Equipment Check - Indicates that the two readings of a column did not agree. Also indicates that the read station failed before beginning to read.

Data Check - Indicates that the machine has detected an invalid card column (more than one punch in rows 1-7) in data mode 1.

2501 Card Reader

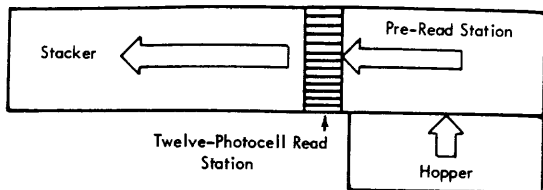

Ready indicates that the 2501 can accept a command from the program.

The ready light comes on when the following conditions exist:

1. Power is on.
 2. A card is registered at the pre-read station.
 3. Cards are in the hopper, or the end-of-file key has been pressed.
 4. The stacker is not full.
 5. No feed check condition exists.
 6. No cover interlocks are opened.
 7. The stop key has not been pressed since the last depression of the start key.
- NOTE: Device end status is generated when the 2501 is made Ready. If the 2501 is made Not Ready, and then made Ready again before the channel accepts the first Device End, the ready light does not come on until this status is accepted.

Read Check (Equipment Check sense indicator) comes on when a card is not being read properly. This condition can result from off-punched cards or incorrect registration of cards in the transport. The Read Check is reset by the next read command from the program when the 2501 is not busy.

Validity Check (Data Check sense indicator) informs the operator that the card just read in data mode 1 contains more than one punch in rows 1-7 of a column. The validity check is reset by the next read command from the program when the 2501 is not busy.

Feed Check (Intervention-Required sense indicator) indicates a card jam or improperly positioned card in the hopper, transport, or stacker; or a failure of one of the read-station photocells or lamps. Usually, a feed check can be reset by an NPRO operation; otherwise, the operator must manually remove jammed cards from the transport or stacker area.

RESTART PROCEDURES for 2501

INDICATIONS	RESTART PROCEDURES
<p>Ready Light off Sense Bit 1 - Intervention Required</p>	<ol style="list-style-type: none"> 1. Check for full stacker, empty hopper, open cover, or actuated stop key. 2. Correct any error condition. 3. Remove cards from hopper. 4. Press NPRO key. 5. Place last card in stacker at front of input cards, and replace this deck in hopper. 6. Press start key.
<p>Ready Light off Feed-Check Light on Sense Bit 1 - Intervention Required</p>	<ol style="list-style-type: none"> 1. If there is a card jam, correct any jammed cards. If there is no jam, proceed to step 2. 2. Remove cards from hopper. 3. Press NPRO key. 4. Place card just run out ahead of cards from hopper, and place this deck in hopper. 5. Press 2501 start key.
<p>Ready Light on Read-Check Light on Sense Bit 3 - Equipment Check</p>	<ol style="list-style-type: none"> 1. Error card is last card in stacker. Correct any off-punching it contains. Place corrected card as last card in stacker. 2. Remove cards from hopper. 3. Press NPRO key. One card should enter stacker. 4. Place last two cards from stacker ahead of cards removed from hopper, and place this deck in hopper. 5. Press start key. 6. Restart program.
<p>Ready Light on Validity-Check Light on Sense Bit 4 - Data Check</p>	<ol style="list-style-type: none"> 1. Error card is last card in stacker. Locate and correct invalid punching it contains (more than one punch in rows 1 through 7) and replace it as last card in stacker. 2. Follow steps 2-6 of Sense Bit 3-Equipment Check procedure (one procedure back in this chart).
<p>Ready Light on Sense Bit 5 - Overrun</p>	<ol style="list-style-type: none"> 1. Follow steps 2-6 of Sense Bit 3 - Equipment Check procedure (two procedures back in this chart).

3504/3505 Card Reader and Punch

3504/3505 Stop Indications and Restart Procedures

Source: GA21-9124-3 3505 Card Reader 3525 Card Punch
Subsystem Component Description

THERMAL	STACKER	COVER OPEN	HOPPER
CHECK CARD 8	TRANSPORT 4	FORMAT RESET 2	REPLACE 1 1
NPRO 8	JAM 4	MACHINE CHECK 2	PERMANENT ERROR 1

If indicators are not in a combination shown on any error display, or if an operator recovery action is unsuccessful, treat the condition as a permanent error and perform the procedure specified by the source program.

INDICATION DISPLAYED: NPRO

RECOVERY PROCEDURE:

Recover is likely.

1. NPRO. (Open the hopper door and press the NPRO key.)
2. Place the last 2 cards that entered the active side of stacker 1 in correct sequence under the cards in the hopper and close the hopper door.
3. Press the start key.

NOTE: The permanent error key is operative during this stop.

INDICATION DISPLAYED: NPRO, MACHINE CHECK

RECOVERY PROCEDURE:

Recovery is possible. If desired, perform the procedure specified for the NPRO indication two or three times.

Perform the NPRO indication procedure, or if that procedure fails repeatedly:

1. If the reader has a log-out key, press it and write down the digits on each row of the backlighted panel.
2. If the reader has no log-out key, record the error information from the reader log display at the system console.
3. When you report the problem to the CE, also report the error information you recorded.

NOTE: The permanent error key is operative during this stop.

3504/3505 Stop Indications and Restart Procedures (cont'd)

INDICATION DISPLAYED: NPRO, CHECK CARD

RECOVERY PROCEDURE:

1. NPRO. (Open the hopper door and press the NPRO key.)
 2. Remove the last two cards that entered the active side of stacker 1. The first card stacked is in error; check this card for more than one punch in row positions 1 through 7 in each column and for poor punch registration. (If necessary, replace the card with a card punched correctly offline.) Place the two cards in correct sequence under the cards in the hopper and close the hopper door.
 3. Press the start key.
- Note: The permanent error key is operative during this stop.

INDICATION DISPLAYED: NPRO, HOPPER, REPLACE 1

RECOVERY PROCEDURE:

Recovery is likely.

1. NPRO. (Open the hopper door and press the NPRO key.)
2. Place the last card that entered the active side of stacker 1 back into the hopper, then close the hopper door.
3. Press the start key and the end-of-file key.

NOTE: The permanent error key is operative during this stop.

INDICATION DISPLAYED: NPRO, HOPPER, REPLACE 1, MACHINE CHECK

RECOVERY PROCEDURE:

Recovery is possible. If desired, perform the NPRO and REPLACE 1 procedure two or three times. If you do not perform that procedure, or if that procedure fails repeatedly:

1. If the reader has a log-out key, press it and write down the digits on each row of the backlighted panel.
2. If the reader has no log-out key, record the error information from the reader log display at the system console.
3. When you report the problem to the CE, also report the error information you recorded.

Note: The permanent error key is operative during this stop.

INDICATION DISPLAYED: NPRO, CHECK CARD, REPLACE 1

RECOVERY PROCEDURE:

1. Remove the cards from the hopper and examine the bottom card for anything that may have caused the misfeed (a burred edge, for example). Reproduce this card, if necessary.
2. Press NPRO key.
3. Place the last card that entered the active side of stacker 1 in correct sequence with the card from 1 above and place them under the cards removed from the hopper.
4. Put the cards back into the hopper and close the hopper door.
5. Press the start key.

3504/3505 Stop Indications and Restart Procedures (cont'd)

INDICATION DISPLAYED: NPRO, CHECK CARD, HOPPER, REPLACE 1

RECOVERY PROCEDURE:

1. NPRO. (Open the hopper door and press the NPRO key.)
2. Remove the last card that entered the active side of stacker 1. Check this card for more than one punch in row positions 1 through 7 in each column and for poor punch registration. (If necessary, replace the card with a card punched correctly offline.) Place the card back in the hopper and close the hopper door.
3. Press the end-of-file and start keys.

NOTE: The permanent error key is operative during this stop.

INDICATION DISPLAYED: HOPPER

RECOVERY PROCEDURE:

Except for end-of-file conditions:

1. Fill the hopper and close the hopper door.
2. Press the start key.

For end-of-file:

1. Press the end of file key.
2. Press the start key.

NOTE: The permanent error key is operative during this stop.

INDICATION DISPLAYED: STACKER

RECOVERY PROCEDURE:

1. Empty the full stacker or set stacker 1 switch to point to empty stacker.
2. Press the start key.

NOTE: The permanent error key is operative during this stop.

INDICATION DISPLAYED: COVER OPEN

RECOVERY PROCEDURE:

1. Close all covers.
2. Check last card in stacker area to see that it was completely stacked.
3. Press the start key.

NOTE: The permanent error key is operative during this stop.

3504/3505 Stop Indications and Restart Procedures (cont'd)

INDICATION DISPLAYED: THERMAL

RECOVERY PROCEDURE:

The read lamp has overheated.

1. NPRO. (Open the hopper door and press the NPRO key.)
2. Place last 2 cards that entered the active side of stacker 1 in correct sequence under the cards in the hopper and close the hopper door.
3. Press the start key. If the read lamp has cooled enough, the thermal light will turn off.
4. If the thermal light remains on, allow the lamp to cool for a while, then press the start key again. Repeat this step until the light remains off.
5. Press the start key.
6. If the thermal condition is persistent, call a Customer Engineer.

NOTE: The permanent error key is operative during this stop.

INDICATION DISPLAYED: HOPPER, JAM

RECOVERY PROCEDURE:

1. Remove cards from hopper, repair or replace any damaged cards, and place the removed cards in correct sequence back into the hopper and close the hopper door.
2. Press the start key.

NOTE: The permanent error key is operative during this stop.

INDICATION DISPLAYED: TRANSPORT, JAM

RECOVERY PROCEDURE:

There is a jam or misfeed in the transport. Two cards must be placed back in the hopper.

● Machine without selective stacker:

1. Examine the transport for a jam at the pre-read or read station, or for two cards at the pre-read station.
2. If you only recovered one card from the transport, remove the last card that entered the active side of stacker 1.
3. Place these cards in correct sequence under the cards in the hopper and close the hopper door.
4. Press the start key.

● Machine with selective stacker:

1. Examine the transport, from the start of the pre-read station to the end of the post-read station, for cards.
2. Place the last 2 cards fed (that is, the two cards closest to the hopper) in correct sequence under the cards in the hopper and close the hopper door.
3. Place any remaining cards in their appropriate stackers.
4. Press the start key.

NOTE: The permanent error key is operative during this stop.

3504/3505 Stop Indications and Restart Procedures (cont'd)

INDICATION DISPLAYED: **STACKER, JAM**

RECOVERY PROCEDURE:

1. Remove card jam from the stacker area.
2. Place these cards in correct stacker or stackers, preserving card sequence.
3. Press the start key.

NOTE: Data integrity is preserved. The subsystem cannot ensure card sequence for cards in the jam. The permanent error key is operative during this stop.

INDICATION DISPLAYED: **JAM, CHECK CARD, TRANSPORT**

RECOVERY PROCEDURE:

1. Remove two cards from the transport. If you only recovered one card from the transport, remove the last card that entered the active side of stacker 1.
2. Check the cards; repair or reproduce any with damaged edges.
3. Place cards (or their replacements) in correct sequence under the cards in the hopper and close the hopper door.
4. If selective stacker, place the last two cards fed (that is, the two cards closest to the hopper) in correct sequence under the cards in the hopper and close the hopper door.
5. Press the start key.

NOTE: The permanent error key is active during this stop.

INDICATION DISPLAYED: **JAM, TRANSPORT, HOPPER, REPLACE 1**

RECOVERY PROCEDURE:

There is a jam or misfeed in the transport. One card must be placed back in the hopper.

● Machine without selective stacker:

1. Examine the transport for a jam at the read station or for a card in the pre-read station.
2. If none, remove the last card that entered the active side of stacker 1.
3. Place the removed card in the hopper and close the hopper door.
4. Press the start key and the end-of-file key.

● Machine with selective stacker:

1. Examine the transport for a jam at the read station or for a card in the pre-read station.
2. If you did not remove a card there, examine the post-read station. Remove the card, if any.
3. Place the removed card in the hopper and close the hopper door.
4. Press the start key and the end-of-file key.

3504/3505 Stop Indications and Restart Procedures (cont'd)

INDICATION DISPLAYED: JAM, TRANSPORT, CHECK CARD, HOPPER
REPLACE 1

RECOVERY PROCEDURE:

1. Locate and remove the card from the transport.
2. Check the card for damaged edges.
3. Repair or reproduce the card, if necessary.
4. Place the card in the hopper.
5. Press the start key and end-of-file key.

NOTE: The permanent error key is operative during this stop.

INDICATION DISPLAYED: FORMAT RESET

RECOVERY PROCEDURE:

Indicates that an optical mark read or read column eliminate format has been reset by an unformatted read only command or by an unformatted read, feed and select stacker command. If this error occurs within a job, and if the operator has no other information from the programmer, the operator should press the stop key, permanent error key, then the start key to make the device ready. If this error occurs within a job and the programmer has provided operator instructions, the operator should follow these instructions. If this error occurs at job initiation, the operator should NPRO, place the last two cards entering the active side of stacker 1 in correct sequence under the cards in the hopper, close the hopper door, and press the start key.

INDICATION DISPLAYED: NPRO, PERMANENT ERROR

RECOVERY PROCEDURE:

This is a device permanent error — command reject.

1. Perform the error recovery specified by the source program for this type of error.

INDICATION DISPLAYED: JAM, TRANSPORT, PERMANENT ERROR

RECOVERY PROCEDURE:

This is a device permanent error.

1. If the reader has a log-out key, press it and write down the digits from each row of the backlighted panel.
2. If the reader has no log-out key, record the error information from the reader log display at the system console.
3. When you report the problem to the CE, also report the error information you recorded.

INDICATION DISPLAYED: JAM, MACHINE CHECK, PERMANENT ERROR

RECOVERY PROCEDURE:

Consider this a permanent error condition and perform the procedure specified by the source program. During this procedure the NPRO key should be pressed with the hopper door open to run cards out of the unit.

3525 Card Punch

3525 Stop Indications and Restart Procedures

Source: GA21-9124-3 3505 Card Reader 3525 Card Punch

Subsystem Component Description

CHIP BOX	STACKER	COVER OPEN	FEED OPEN
CHECK CARD 8	PRESS START 4	FORMAT RESET 2	3 CARD RUN IN 1
NPRO 8	JAM 4	MACHINE CHECK 2	PERM ERROR 1
OFFLINE	MIS-SELECT	STACKER 3	PRINT SKEW

If indicators are not in a combination shown on any error display, or if an operator recovery action is unsuccessful, treat the condition as a permanent error and perform the procedure specified by the source program.

INDICATION DISPLAYED: CHIP BOX

RECOVERY PROCEDURE:

1. Remove and empty the chip box.
2. Place the chip box back into the machine.

NOTE: After the chip box light comes on, the punch continues to operate for a reasonable period of time if the box is in the machine and properly positioned. However, when the chip box becomes too full to permit machine operation, the operator call light will come on and the punch will stop.

NOTE: Chip box must be in the tray.

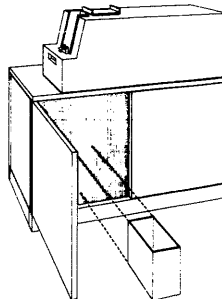
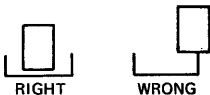

NOTE: The permanent error key is operative during this stop.

3525 Stop Indications and Restart Procedures (cont'd)

INDICATION DISPLAYED: **STACKER**

RECOVERY PROCEDURE:

1. Empty the full stacker.
2. Press the start key.

NOTE: If the stacker light is on and neither stacker 1 nor stacker 2 is full, check for the reject stacker being full.

NOTE: The permanent error key is operative during this stop.

INDICATION DISPLAYED: **COVER OPEN**

RECOVERY PROCEDURE:

1. Close any cover that is open.
2. Press the start key.

NOTE: The permanent error key is operative during this stop.

INDICATION DISPLAYED: **FEED OPEN**

RECOVERY PROCEDURE:

1. Make sure upper read head is latched.
2. Close and latch the feed mechanism.
3. Press the start key.

NOTE: The permanent error key is operative during this stop.

INDICATION DISPLAYED: **JAM, 3 CARD RUN IN**

RECOVERY PROCEDURE:

1. Remove cards from the transport manually, keeping them in sequence.
2. Repair or reproduce any damaged cards offline; reassemble cards in correct sequence and place them with undamaged cards.
3. ● If 3 CARD RUN IN is blinking, place the last two cards below the cards in the hopper and discard the preceding card.

● If 3 CARD RUN IN is *not* blinking, place last three cards below cards in hopper.
4. Place remaining cards in correct stacker or stackers.
5. Press the start key.

NOTE: The permanent error key is operative during this stop.

3525 Stop Indications and Restart Procedures (cont'd)

INDICATION DISPLAYED: **JAM, MACHINE CHECK, 3 CARD RUN IN**

RECOVERY PROCEDURE:

1. Remove all cards from the transport manually, keeping them in sequence.
2. Repair or reproduce any damaged cards offline, then put them, in correct sequence, with the undamaged cards.
3. Place all cards removed at the bottom of the deck in the hopper.
4. Press the start key.

NOTE: The permanent error key is operative during this stop. This is the only time that more than three cards can be returned to the hopper.

INDICATION DISPLAYED: **NPRO, MACHINE CHECK**

RECOVERY PROCEDURE:

1. Empty stacker 1.
2. NPRO (While holding cards in hopper away from bottom of hopper, run cards out of transport by holding the NPRO key down.)
3. Remove all other cards from stacker 1 and place them in their correct stacker or stackers, if possible. If you cannot determine the correct stackers for these cards, put them aside for later manual distribution.
4. Press the start key.

NOTE: The permanent error key is operative during this stop.

INDICATION DISPLAYED: **JAM**

RECOVERY PROCEDURE:

1. Remove cards from the card transport area manually, keeping the cards in their correct sequence.
2. Repair or reproduce any damaged cards.
3. Place these cards in their correct place with those removed from the transport area.
4.
 - If the jam occurred during a run-in operation:
 - a. Place the cards in the hopper.
 - b. Press the start key.
 - If the jam occurred during an NPRO operation:
 - a. Place the cards in their appropriate stackers.
 - b. Continue performing the procedure under progress when the jam occurred.

NOTE: The permanent error key is operative during this step.

INDICATION DISPLAYED: **JAM, PRESS START**

RECOVERY PROCEDURE:

1. Remove cards from stacker manually, keeping cards in correct sequence.
2. Repair or reproduce any damaged cards offline, then reassemble them in correct sequence with the undamaged cards; place all these cards in the stacker(s).
3. Press the start key.

NOTE: The permanent error key is operative during this stop.

3525 Stop Indications and Restart Procedures (cont'd)

INDICATION DISPLAYED: MACHINE CHECK, PRESS START

RECOVERY PROCEDURE:

1. Press the start key.

NOTE: The permanent error key is operative during this stop.

INDICATION DISPLAYED: NPRO, 3 CARD RUN IN

RECOVERY PROCEDURE:

1. Remove cards from hopper and examine throat area.
 - a. If partially-fed card is stuck in throat, remove it, repair or replace it, and put it on bottom of stack removed from hopper.
 - b. Remove any dust or pieces of paper from throat area.
2. Empty stacker 1.
3. NPRO (press the NPRO key.)
4.
 - If 3 CARD RUN IN is blinking, discard first card that entered stacker 1; place any other stacker 1 cards in hopper.
 - If 3 CARD RUN IN is not blinking, place all cards that entered stacker 1 in hopper.
5. Place cards removed from hopper back into hopper.
6. Press the start key.

NOTE: The permanent error key is operative during this stop. During NPRO, three cards should enter stacker 1 unless one card was stuck in throat; if card was stuck in throat, two cards should enter stacker 1.

INDICATION DISPLAYED: JAM, PERMANENT ERROR

RECOVERY PROCEDURE:

1. Manually remove all cards from the card transport.
2. Perform the procedure specified by the source program

INDICATION DISPLAYED: JAM, MACHINE CHECK, PERMANENT ERROR

RECOVERY PROCEDURE:

1. Manually remove all cards from the card transport.
2. Perform the procedure specified by the source program.

INDICATION DISPLAYED: JAM, PRESS START, MISSELECT

RECOVERY PROCEDURE:

A punch error occurred and the error card failed to enter stacker 3.

1. Examine the last cards to enter stackers 1 and 2 for a card containing a punch error. Place this card in stacker 3.
2. Press the start key.

NOTE: The permanent error key is operative during this stop.

3525 Stop Indications and Restart Procedures (cont'd)

INDICATION DISPLAYED: JAM, PRESS START, MISSELECT, STACKER 3

RECOVERY PROCEDURE:

For a non-punch or read-punch job,

1. Examine stacker 3 for error-free data cards misselected into the stacker.
2. Place these cards in stacker 1 or stacker 2, as appropriate.
3. Press the start key.

For an unknown job,

1. Examine all stackers for misselected cards.
2. If correct stacker can be determined, place cards in correct stacker and press start key.
3. If correct stacker cannot be determined, post permanent error.

NOTE: The permanent error key is operative during this stop.

INDICATION DISPLAYED: PRINT SKEW, PRESS START

RECOVERY PROCEDURE:

1. Inspect the last 2 cards in each stacker for skewed printing. If necessary, manually reproduce and print the cards, or place them aside for later reproduction.
2. Replace these cards in their correct stackers.
3. Press the start key.

NOTE: The permanent error key is operative during this stop.

INDICATION DISPLAYED: NPRO, PERM ERROR

RECOVERY PROCEDURE:

1. Press stop key, then logout key. If logout number is 4 and 2 on upper line and the lower line is blank, go to step 4. Otherwise, go to step 2.
2. Check for card jam between punch and print stations. If there is a jam, remove cards from transport, then go to step 4. If no jam exists, go to step 3.
3. Did someone NPRO a job without NPRO or PERM ERROR lighted? If so, restart the job. If not, cancel the job and have the program corrected.
4. Perform the procedure specified by the source program. During this procedure, run cards out of the transport by pressing the NPRO key.

3525 Stop Indications and Restart Procedures (cont'd)

INDICATION DISPLAYED: NPRO, CHECK CARD

RECOVERY PROCEDURE:

1. Press the stop key: the 3-card run-in light will come on.
2. Empty stacker 1.
3. NPRO. (While holding cards in hopper away from bottom of hopper, run cards out of transport by holding the NPRO key down.)
4. If there are cards remaining in the hopper and only two cards NPRO to stacker 1, press permanent error key twice to cause two card run-in.
5. Remove and examine the cards that ran into stacker 1. Repair, or replace with a manually-reproduced card, any damaged cards.
6. Place all these run-out cards under the deck in the hopper, maintaining correct card sequence.
7. Press the start key.

NOTE: The permanent error key is operative during this stop. If indication is continuous, check to be sure that upper read head is latched.

INDICATION DISPLAYED: FORMAT RESET

RECOVERY PROCEDURE:

Indicates that a read column eliminate format has been reset by an unformatted read only command or by an unformatted read, feed, and select stacker command. If this error occurs within a job, and if the operator has no other information from the programmer, the operator should press the stop key, permanent error key, then the start key to make the device ready. If this error occurs within a job and the programmer has provided operator instructions, the operator should follow these instructions. If this error occurs at job initiation, the operator should NPRO (lift the cards off the bottom of the hopper and press the NPRO key), load the last two cards entering stacker 1 back under the cards in the hopper, and press the start key.

NOTE: The permanent error key is operative during this stop

INDICATION DISPLAYED: OFFLINE

RECOVERY PROCEDURE:

Indicates that the 3535 is disconnected from the system functionally.

To place the 3525 online:

1. Set the ONLINE/OFFLINE switch to its ONLINE setting.

NOTE: The ONLINE/OFFLINE switch is located at the attachment. If the 3525 is attached to the 3505, the switch is under the 3505 front cover.

3525 Stop Indications and Restart Procedures (cont'd)

INDICATION DISPLAYED: 3 CARD RUN IN

RECOVERY PROCEDURE:

The recovery from the previous error has not been completed.

1. ● If 3 CARD RUN IN is blinking, clear the transport and discard the card at the print station.
● If 3 CARD RUN IN is *not* blinking, clear the transport, but do not discard the card.
2. Continue with the recovery procedure being performed when this display came on.

If you are starting a new job, press the permanent error key twice to cancel the recovery. **CAUTION:** Pressing the key cancels the recovery and recovery cannot be accomplished.

INDICATION DISPLAYED: PERMANENT ERROR

RECOVERY PROCEDURE:

If this indicator is lighted and you did not press the permanent error key deliberately, press the permanent error key to turn the light off. This will ensure that a permanent error indication posted for the last job, (or one resulting from an unintended depression of the permanent error key) will not be associated with the present job.

INDICATION DISPLAYED: STACKER 3

RECOVERY PROCEDURE:

The stacker 3 indicator can be on either alone or in combination with other indications. It comes on when a card enters the reject stacker and remains on until the start key is pressed.

If the job being processed is a data security job—that is, if it is important for the cards or the information they contain to be kept under security—the reject stacker (stacker 3) must be emptied, as part of the restart procedure before the start key is pressed, and at the end of the job. Nonsecurity error cards should be collected for the customer engineer's examination.

INDICATION DISPLAYED: 3 CARD RUN IN, PRESS START

RECOVERY PROCEDURE:

1. Ensure that the last card stacked entered the correct stacker.
2. Remove cards from the transport manually, keeping them in sequence.
3. Repair or reproduce any damaged cards offline; reassemble cards in correct sequence and place them with undamaged cards.
4. Place last three cards below the cards in the hopper.
5. Place remaining cards in correct stacker or stackers.
6. Press the start key.

NOTE: The permanent error key is operative during this stop.

LOG-OUT INDICATIONS (NUMBERS)

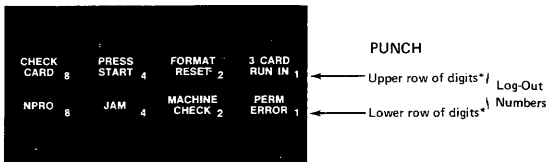
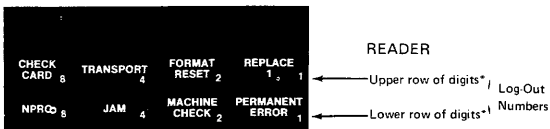

*Ignore the words.

The back lighted panel serves two functions. Normally, the panel displays indications that show the operator what procedure to follow to recover from an error. (These indications have been discussed earlier in this manual.) When a permanent error occurs that requires machine repair, the recovery procedure directs the operator to press the log-out key. When a permanent error occurs that requires machine repair, the recovery procedure directs the operator to press the log-out key. This causes the panel to display a different set of indications, which are called log-out numbers. (The words displayed on a log-out indication are meaningless and should be ignored.) When the operator calls to report the problem, he should tell the customer engineer what digits are displayed in the upper row, then what digits are displayed in the lower row. If no digits are shown in a row, the operator should report that the row is blank.

EXAMPLE:

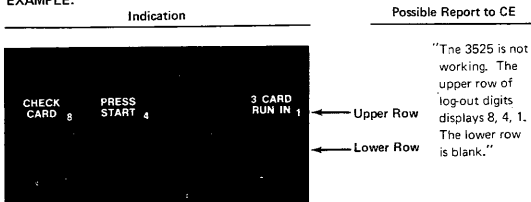

3525 Card Punch

3525 Error Recovery Routines

*Source: GA21-9124-3 3505 Card Reader 3525 Card Punch
Subsystem Component Description*

Before any programmed punch and/or print retries are performed, the operator must remove all cards that must be completely or partially reprocessed. Your source program error recovery routine can help the operator to decide which cards need to be removed. Some of the information your routine could provide is:

1. The number of cards to be removed.
2. The location of the cards to be removed.
3. Identification by data content of the cards to be removed.
4. The number of blank cards to be put in the 3525 for the recovery procedure.

The error recovery routine should then punch and/or print the data for the card that must be completely reprocessed. Then punch and/or print the data for the next card that must be partially reprocessed. The error recovery routine can then return to the normal source program to finish processing that next card.

For specific recovery techniques, be guided by the error message you receive from the System Control Program in use.

OS/VS1 Checkpoint Restart

Source: GC26-3784 OS/VS Checkpoint/Restart

HOW TO RESTART A JOB

Automatic Restart

When you receive the message requesting your authorization for a restart:

```
xxIEF225D SHOULD jobname.stepname.procstepname [checkid] RESTART
```

you must reply to the request as follows:

```
riid,{ 'YES' }  
      { 'HOLD' }  
      { 'NO' }
```

YES authorizes the restart, HOLD postpones it, and NO prohibits it. After a YES reply the job is reinterpreted by a restart reader named IEFREINT that is started automatically by the system, and if a MONITOR JOB NAMES is in effect, IEFREINT STARTED and IEFREINT ENDED messages are displayed. These are followed by normal mount messages and a successful restart message.

Deferred Restart

To perform a deferred step restart in VS1, the job to be restarted must be resubmitted. Normal mount messages are displayed.

OS/VS2 Checkpoint Restart

Source: GC26-3784 OS/VS Checkpoint/Restart

HOW TO RESTART A JOB

Automatic Restart

During processing related to automatic checkpoint/restart in VS2, the system issues the following sequence of messages to the operator:

1. A message each time a checkpoint entry is written. Each message contains the checkpoint id.
2. An ABEND message for the job step if it terminates abnormally:

IEF450I jobname,stepname,procstepname ABEND code

3. If the ABEND code makes the job step eligible for restart, the system issues this message:

xxIEF225D SHOULD jobname.stepname.procstepname [checkid] RESTART

to which the operator must reply:

rid, { 'YES' }
{ 'HOLD' }
{ 'NO' }

YES authorizes the restart, HOLD postpones it, and NO prohibits it. If restart is authorized and MONITOR JOB NAMES is in effect, messages IEFREINT STARTED and IEFREINT ENDED will appear. IEFREINT is the name of the 'restart reader.'

4. Message indicating the virtual storage requirements (beginning address and ending address) of the job step to be restarted.
5. Normal mount messages.
6. A successful restart message.

Deferred Restart

To perform a deferred step restart in VS2, the job to be restarted must be resubmitted. Messages containing checkpoint entry ids displayed previously on the console during original execution of the job may be used by the programmer preparing the job for resubmission. When the resubmitted job is restarted, the operator will receive these messages on the console:

1. A message indicating virtual storage requirements of the job.
2. Normal mount messages.
3. A successful restart message.

IBM 3340 Disk Drive

Source: GA26-1619 IBM 3340 Reference Manual

READ ONLY FUNCTION

The means to protect previously written data modules is provided by the Read Only function. The following procedures show how to enable or disable the Read Only function for either 3348 model.

Enable Read Only Function

1. With data module removed from the drive, press down on IBM logo inset of the handle (A).

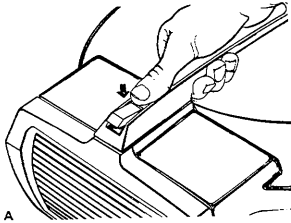

2. Turn inset 180° and snap into place (B).
3. The data module may now be loaded in the desired drive.

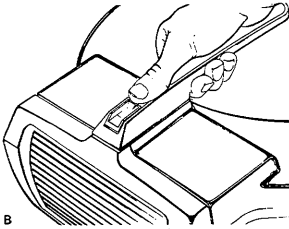

IBM 3340 Disk Drive

Disable Read Only Function

1. With the data module removed from the drive, return the IBM logo inset to its original position (reverse 180°) (C).
2. The data module may now be loaded into the desired drive.

Note: Do not attempt to enable or disable the Read Only function while the data module rests in the drive shroud recess.

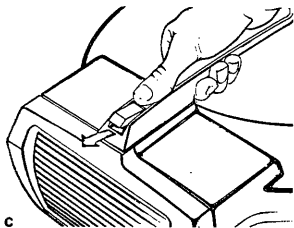

Operating Hints

When you take a 3340 drive offline and want to start it up again, press START STOP. The drive cycles up. Then press the ATTENTION button. ATTENTION must be used to signal the system that the drive is ready.

Do not use Power-On or Power-Off switches to load or unload the data module, because these switches are bypassed by the subsystem sequencing controls during a subsystem power-up or power-down operation. Power is turned on or removed by the subsystem sequencing controls.

Console File S/370 Mod 125

Source: GA33-1509-0 System/370 Mod 125 Procedures

The console loads microprogram on diagnostic programs into the system. It is also used by the system to store logs. The microprogram diagnostic programs and logs are stored on lightweight magnetic disk cartridges (diskettes).

IBM Diskette

Source: GA33-1509 System/370 Mod 125 Procedures

There are two types of diskettes:

- The system diskette
- The service diskette

The System Diskette is used for normal operation.

The Service Diskette is used for loading ASCP.

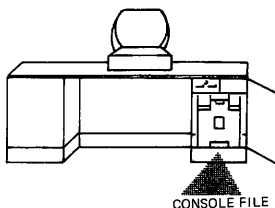

Because the magnetic disk cartridge (diskette) contains information that is vital to system operation, it must be properly safeguarded.

Avoid:

- Rough handling of the diskette. Never write on or mark the diskette.
- Localized pressure on any part of the diskette.
- Strong, direct sunlight on the diskette.
- Attempts to clean the diskette in any way.
- Exposure of the diskette to magnetic fields. Keep away from all metal objects.
- Touching of exposed diskette surfaces. Use the handling area. If a magnetic disk cartridge is damaged, inform the CE.

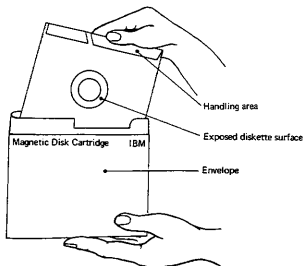

IBM Diskette

Operating Procedures

Source: GC38-0015-3 IBM System/370 Mod 145 Operating Procedures

CONSOLE FILE CARTRIDGE INSERTION and REMOVAL

Insertion

1. Pull handle **A** to open console-file cover.
2. Grasp the cartridge **B** by its white handling area and remove it from its envelope.
3. Lower the cartridge **C** until it is stopped by the locating surfaces.
4. Close cover carefully **D**. The centering cone must slide freely into the center of the disk. If not, check that the cartridge is seated against the locating surfaces and that the cartridge is not damaged.
5. Return the empty carriage envelope to the disk storage rack. **E**

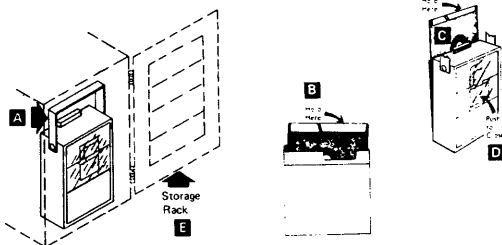

Removal

1. Pull handle **A** to open console-file cover.
2. Grasp the cartridge **B** by its white handling area and lift it straight up.
3. Slide the cartridge into its envelope and return it to the disk storage rack **E** or to the storage area.

Storing Cartridges

Before using, acclimate cartridges to the computer room:

- If in mailing carton, wait 24 hours.
- If not in mailing carton, wait 1 hour.
- If mounted on a nonpowered file, wait ½ hour.

Place cartridges in their envelopes and store them either in the storage rack or in their original mailing cartons. A storage environment should meet the following criteria:

Temperature	40°–100°F (4.4°–37.8°C)
Relative Humidity	8%–80%
Maximum Wet Bulb Temperature	80°F (26.7°C)

Shipping and Receiving

Ship cartridges inside the original shipping carton. Additional shipping cartons are available at IBM Branch Offices. With the cartridge in place, the package weighs 10 ounces. Be sure to label the package, "DO NOT EXPOSE TO HEAT OR SUNLIGHT."

When receiving cartridges, check for carton and cartridge damage. Save the carton for storing a cartridge and for possible future cartridge shipment.

IBM Diskette (cont'd) Cartridge Handling

Source: GC38-0015-3 IBM System/370 Mod 145 Operating
Procedures

- The disk cartridge contains information vital to system operation which may not be easily duplicated. **HANDLE THE CARTRIDGE WITH CARE!**

CAUTIONS

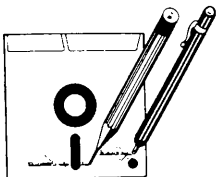

- No pens or pencils. Never write on disk cartridge. Writing pressure damages disk.

- No smoking while handling cartridges.

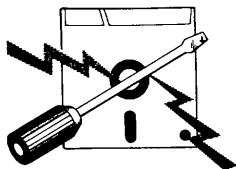
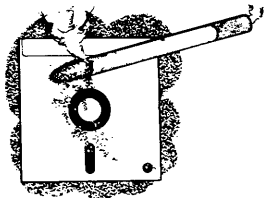

- Keep cartridge away from magnetic fields or from ferromagnetic materials which might be magnetized.

- Do not expose cartridges to heat or sunlight.

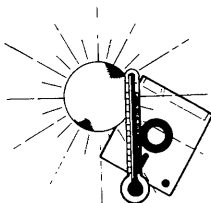

IBM Diskette (cont'd) Cartridge Handling (cont'd)

- Replace cartridge envelopes when they become worn, cracked, or distorted.

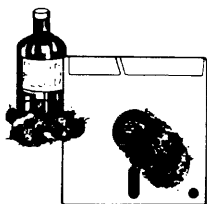

- Do not touch or clean the disk surface.

- Return cartridge to envelope whenever it is removed from the console file.

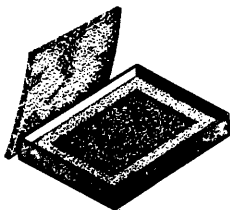
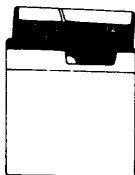

- Store cartridges in their original shipping cartons, or in the storage rack on the access door.

IBM 3410/3411 Tape Drive

Source: G232-0004 3410/3411 Operator's Guide

Operating Procedure after Failures*

1. The tape unit fails to sense the BOT marker and continues to search forward for it.
 - a. Ensure that the BOT marker is properly positioned 14 to 18 feet from the physical beginning of tape. (If not, replace the marker.)
 - b. Re-try load procedure, ensuring that the BOT marker is to the left of the left-hand idler before pressing the LOAD REWIND button.
2. Tape fails to load properly in either column or both columns, or it dumps in either column.

Open vacuum column door and check the door and column edges for contaminants that may have prevented proper sealing. Re-try load procedure.
3. Tape unit fails to sense the end-of-tape (EOT) marker and tape unwinds completely off file reel.
 - a. Ensure that the EOT marker is properly positioned approximately 25 feet from the physical end of tape. (If not, replace the marker.) If the marker is properly positioned, the failure could be a programming error or a machine malfunction.
 - b. Thread tape back across idlers and onto the file reel. Manually wind 10 to 15 turns counterclockwise on file reel and remove all slack. Press the LOAD REWIND button. As soon as the tape is loaded and starts to move, press the RESET button. Then press either the LOAD REWIND or the UNLOAD REWIND button, depending on the action desired.
4. Permanent write failures occur immediately beyond BOT.
 - a. Check the read/write head for contamination. If any doubt exists, clean the head (see "Cleaning Procedures"). Re-try job.
 - b. If problem recurs, mount a different reel of tape and re-try job.
5. Power is dropped while tape is loaded and not at BOT.

Manually rewind all slack between reels. Restore power and press the RESET and LOAD REWIND buttons. Tape loads into columns and starts moving forward. Again press the RESET button and then press either the LOAD REWIND or the UNLOAD REWIND button, depending on what action is desired.

Cleaning Procedures

Clean tape transport and capstan every eight hours. Use cleaning kit, part 352465, and tape transport cleaner.

Note: Use IBM tape transport cleaner, part 453511, or competitive formulations of the same chemical composition. Performance results cannot be guaranteed when other chemical formulations are used, because they have not been tested by IBM, and their use may impair performance or cause damage to the tape unit or tape.

CAUTION

1. Avoid prolonged skin contact with tape cleaner.
 2. Never clean a tape unit with a metal object. Use only materials specified for each operation.
 3. Never touch rubber capstan surface with bare fingers; moisture or oil impairs tape-to-capstan friction.
 4. Remove any tape cleaner dropped in the tape path, on the tape guides, or on the idlers during cleaning.
 5. *Don't use water in the capstan area or the read/write head area.*
 6. Never get fluids of any kind in or near the column sensors.
 7. Do not use the flat area of top cover or the sliding door surface as a work area.
- * If failures continue after recommended action has been taken, notify the CE.

IBM 3410/3411 Tape Drive

Tape Transport Cleaning

Source: G232-0004 3410/3411 Operator's Guide

Tape Transport Cleaning

1. Unload tape and remove from tape unit.
2. Clean tape guides, tape path, idlers, vacuum columns, and vacuum column door with a lint-free cloth moistened with tape cleaner. Use the small brush moistened with tape cleaner to clean the cleaner blade and corners of tape guides. Water may be used to remove oxide residues only in the vacuum columns. Do not use water on or near the capstan, column sensors, or the read/write head.
3. Clean the read/write head surface with the small brush.
4. Wipe the read/write head and the erase head with a lint-free cloth moistened with tape cleaner.
5. The cleaning slots are used for brushing residue out of the recessed areas in the deck.

Capstan Cleaning

1. Rotate the capstan with a finger covered with a lint-free cloth. With the other hand, wipe the capstan surface with a lint-free cloth moistened with tape cleaner. Use no water in this area, and AVOID EXCESSIVE cleaning pressure.
2. Dry the capstan surface with a lint-free cloth before loading tape. AVOID EXCESSIVE PRESSURE.

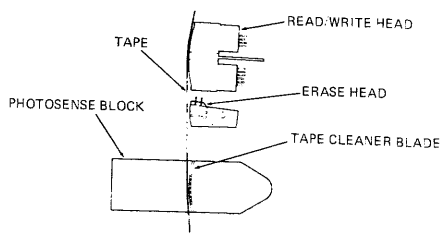
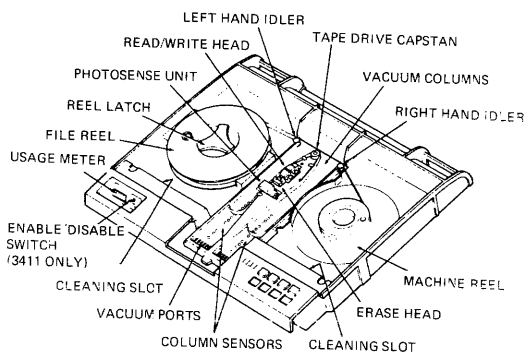

IBM 3410/3411 Tape Drive

Tape Handling and Storage

Source: GA32-0022 IBM 3410/3411 Magnetic Tape Subsystem
Component Description

Tape Handling

A tape reel that is not in use on a tape unit should always be stored in its container. Establish procedures to protect magnetic tape from contamination which causes degraded tape unit performance. Some common rules are:

1. Never leave tape reels or containers exposed. Tape may be damaged, or dust accumulating on the tape or in the container can contaminate the tape.
2. Erasing a tape reel identification label is a cause of contamination. Use new labels when changing reel identification. Select a label with an adhesive backing that does not leave a residue and that can be applied and removed easily.
3. Never allow a loose end of tape to trail on the floor; dirt picked up in this manner can reach the tape transport and be passed on to other sections of the tape.
4. Do not allow smoking in areas where tape is in use. Ashes contaminate tape. Live ashes can permanently damage the tape surface.
5. Don't touch the tape edges through the reel openings or press on the reel flanges. Such pressure will compress the tape and damage its edges.
6. Be very careful when removing the write-enable ring. Always unload tape before removing the write-enable ring; never remove the ring while tape is loaded on the tape unit.

Tape Storage

To prevent tape contamination and damage during storage, follow these procedures:

1. Before a tape is stored, secure the loose end of tape with a tape end retainer to prevent the tape from unwinding in the container.
2. Use gum-free type labels only.
3. Always store tape in an upright position. Never store tapes flat or in stacks; accidental damage or reel warpage may result.
4. Store tapes in a cabinet or shelf elevated from the floor and away from sources of paper and dust. Dust can be transferred from the outside of the container to the reel during load and unload operations.
5. To increase life of tapes and system performance, maintain library room temperature at 70° to 75°F and humidity at 30%. Humidity level is important.

IBM 3420 Tape Drive

Source: S232-0003-2 IBM 3420 Operator's Guide
GA32-0020 IBM 3803 3420 Magnetic Tape
Subsystem Component Description

CLEANING PROCEDURE

Refer to *Tape Unit Cleaning Procedure*, order number GY32-5034-0.

OPERATING PROCEDURES AFTER FAILURE

Tape Fails to Thread (With Cartridge)

1. Remove reel and cartridge.
2. Ensure tape end is undamaged and hangs free in cartridge (if necessary, trim end with cutter, part 2512063).
3. Check that unlatching cartridge toggle opens tape port.
4. Remount reel and cartridge and retry load procedure.
5. If failure recurs, remove reel from cartridge and try load procedure without cartridge.

Tape Fails to Thread (Without Cartridge)

1. Ensure tape end is undamaged and positioned in threading chute (if necessary, trim end with cutter, part 2512063).
2. Open doors and clear any obstructions from tape path.
3. Close doors and retry load procedure. If unit still fails, notify CE.

End of Tape Comes Off Machine Reel Hub as Tape Loads in Columns

Check leader length (distance from tape end to BOT marker). Tapes with less than 10-foot (3m) leaders may not load reliably. To recover information from tape with short leader, attach additional temporary leader with clear cellophane tape.

NOTE: After information is recovered (reproduced on another tape reel), recondition source reel by cutting off old leader and BOT marker. Trim end with cutter, and apply new BOT marker about 15 feet (4,6m) from leading end. Have marker parallel to and about 1/32 inch (0,8 mm) from front edge of tape. Marker must not be wrinkled nor extended beyond tape edge.

Tape Unit Fails to Sense EOT Marker (Tape End Comes Off File Reel)

Verify presence of EOT marker approximately 25 feet (7,6m) from end of tape. If marker is present, malfunction could be program error or machine failure—notify CE.

1. **Rewind Procedure—With Cartridge:**
 - a. Open front door and manually wind remaining tape on machine reel. Close front door and press RESET and UNLOAD. When cartridge closes, remove cartridge and reel and mount an empty reel on machine.
 - b. Open doors, manually thread tape from machine reel through tape path, and wind approximately ten turns of tape on file reel. Close doors and press LOAD/REWIND.
 - c. Unload tape unit and return reel to cartridge when rewinding is complete.
2. **Rewind Procedure—Without Cartridge:**

Do (b) above. Unload tape unit when rewinding is complete.

Tape Threads Successfully But Fails to Load in Columns

Check for missing BOT marker, or incorrect leader length (distance from tape end to BOT marker). Tapes with more than 30-foot (9m) leaders may not load reliably. If neither condition is present, notify CE.

IBM 3420 Tape Drive (cont'd)

Window Fails to Open After Unload Operation

1. Open access door and manually wind remaining tape onto file reel.
2. Close front door and press RESET and UNLOAD.
3. Notify CE.

Channel Fails to Select Tape Unit (Device Switching or Two-Channel Switch Feature Installed)

Check that toggle switches on the appropriate 3803 operator's panel are set to enable selection of the desired tape control and tape unit. (Refer to *Subsystem Description—IBM 3803/3420 Magnetic Tape Subsystems*, order number GA32-0021, for a description of switch functions.)

WRITING A TAPE MARK (3803/3420)

1. Set the ENABLE/DISABLE switch(es) on the control unit operator's panel to 'Disable'. The CPU should be stopped momentarily (press STOP then START at the CPU) to ensure that the control unit becomes disabled.
2. Open the 3803 back cover. (Remove rings, wristwatches, chains, bracelets, or metal cufflinks.)
3. Set CE panel switches as follows:
 - a. PANEL ENABLE to 'enable'.
 - b. ROS MODE (rotary switch) to 'norm'.
 - c. DATA ENTRY SELECT to 'cmdn1'.
 - d. DATA ENTRY (three switches) to '1FX (PE tape mark), where X is the address (hex) for the tape unit that is to write the tape mark.

Note: To write an NRZI tape mark, two commands must be loaded and executed. The first is the appropriate mode set, and the second is the write tape mark (WTM). At this point, enter mode set command and TU number in the three DATA ENTRY switches (hex).

- e. MPLE/SINGLE to 'single'.
 - f. DISPLAY SELECT to 'CE reg'.
4. Activate the following switches in the sequence shown:
 - a. SET ROS MODE/SET CE/CMPR to 'set ROS mode' then to 'set CE cmpr'.
Note: To write an NRZI tape mark, set DATA ENTRY switches to 1FX (see step 3d), and DATA ENTRY SELECT to 'cmdn 2'. Press 'Set CE/cmpr' again.
 - b. RESET/START or STOP to 'reset'.
 - c. STOP/START to 'start'. This writes a PE tape mark. (Press 'start' again to write an NRZI tape mark.)
 - d. Repeat steps 4b and 4c to write additional tape marks.
 5. Set the PANEL ENABLE switch down (OFF), close the rear cover, and set the channel ENABLE switch to the desired position.

CAUTION: Failure to turn off the PANEL ENABLE switch could disrupt system operation at some later time.

IBM 1403 Printer

Source: SR20-1078 S/360 Operator's Reference Guide

1403

Suggested Restart Procedures for 1403

An I/O error causes an interruption condition. When unit check is detected by the program, sense information sent from the device control unit provides more detailed information concerning the cause of the unit check. As a result of program analysis of the sense information, an error message should be made available to the operator to indicate the condition.

The following information describes the minimum actions that should be performed when the program detects unit check.

The actions are related to particular sense indications that can occur. These bits are analyzed by the program. The choice of action(s) to be taken by the operator must be established at the installation.

Intervention Required (Sense Bit 1)

The printer enters a not-ready condition (Ready light off) because one of the following has occurred:

1. The 1403 Stop key is pressed. (Possible operator error).
2. A mechanical interlock, such as the print unit, is open. (Possible operator error).
3. A forms check. When the Forms-Check light is on, paper feed trouble has occurred or the Carriage Stop Key has been pressed. (Also, the Ready light is off). Any jam condition must be corrected and the Check-Reset key must be pressed before the Start Key is effective. The program should provide an operator message and exit from this error recovery procedure. The operator should then perform one of the following:
 - a. Correct the not-ready condition, accept the record, and allow the application program to proceed without further retries of the command, or
 - b. Correct the not-ready condition and restart the program from a logical restart point. The logical restart point should be determined at the installation and specified to the operator.
4. End of forms. If an end-of-forms has occurred, the End-of-Forms light is on and the Ready light is off. To reset the printer, press the printer Start Key. The remaining lines of the form are then printed under program control. (Note that the Start Key is pressed only once.)

When a hole is then sensed in channel 1 of the carriage tape (either space to or skip to or by channel-1), the operation is terminated with both the End-of-Forms and Forms-Check lights on and the Ready light off. Printing does not occur for the line at which the channel-1 hole is sensed. Therefore, a carriage tape with a hole punched in channel 1 should be on the carriage. If there is no hole in channel 1, printing continues even if no forms are in the printer (except for Selective Tape Listing operations).

If no skip-to-channel-1 command is issued, lines are printed (after the last form) until the channel-1 punch is sensed. (For Selective Tape Listing operation, new tapes should be mounted when the end-of-forms indication occurs.)

IBM 1403 Printer (cont'd)

The program should provide an operator message and exit from this error recovery procedure when the end-of-forms indication is detected. The operator should then perform a forms runout (as just described) and satisfy the requirements of the application program.

5. **Sync check.** This condition can occur whenever the print chain (or train) is out of synchronism with the print circuitry in the 2821. Depending upon when the sync check occurs, one of the following conditions exists:
 - a. The sync check occurred when no printing was in progress (no line was printed).
 - b. The sync check occurred during a print operation and one line was printed.
 - c. The sync check occurred during printing and two lines were printed.

The program should provide an operator message and exit from this error recovery procedure. The operator should then:

- a. Correct the not-ready condition (press the Check-Reset key and then the Start key) and allow the application program to proceed without further retries of the command, or
- b. Correct the not-ready condition (press the Check Reset key and then the Start key) and restart the program from a logical point.

If the error persists, a call should be made to the Customer Engineer.

Data Check

Data check indicates that a code in a data record sent to the printer does not match a code in the UCS (Universal Character Set) feature storage. Printing does not occur in the print position to which the unmatching code applies. The entire line (except for the data check position) or only a portion of the line may be printed. Therefore, the last printed line may contain erroneous data and/or an incomplete record. Data check generally indicates that the UCS storage was improperly loaded or that a data record code (other than blank or null) does not compare to any code in the UCS storage.

The program should provide an operator message and exit from this error recovery procedure. The operator should then:

1. Accept the record and indicate that the application program is to proceed without further retry of the command, or
2. Cause the application program to restart from a logical point.

If the error persists, a call should be made to the Customer Engineer.

Parity Check

This bit indicates that a parity error has been detected in the UCS feature storage. The parity check can be reset only if the UCS storage is reloaded.

If the parity check occurs while the UCS storage is being loaded, retry the operation once. If the error persists, a call should be made to the Customer Engineer.

If the parity check occurs during printing, the last print line may contain erroneous data. Provide an operator message and exit from this error recovery procedure. At this time, the operator should:

1. Accept the record, cause the program to reload the UCS storage and proceed without further retry of the command, or
2. Cause the program to reload the UCS storage and restart the program at a logical point.

If the error persists, a call should be made to the Customer Engineer.

IBM 3203 Printer

Source: GA33-1515 IBM 3203 Printer, Component Description and Operator's Guide

Error Recovery

The following text describes the minimum action the operating system should take to deal with errors or other unusual conditions that may occur. Errors and other unusual conditions are usually indicated by the setting of unit check or any of the other status bits (except an end condition or busy) in the CSW.

Note: The only satisfactory method of recovering from print errors — both mechanical failures (lack of forms movement, torn forms) or electrical failures (data checks, sync checks) — is to print from a retrievable data set on disk or tape, instead of from an area in storage. Since DOS and DOS/VS do not support such recovery, the recommended actions must be programmed by the user.

The procedure is to print from an intermediate storage so that a complete page can be reprinted in case of failures. At least three pages should be stored on disk or tape before the print job begins. Then a counter should be stepped up (or down) for each page that is printed free of errors. If a failure occurs, the counter would indicate which page is to be retrieved for reprinting. When three pages have been printed successfully, the next three pages can be loaded. Three pages should be used in order to cover any error in skipping from page to page. The method also allows an invalidation message to appear on misprinted forms.

Unit Check in CSW

When a command ends with unit check set in the CSW, the operating system should issue a 'sense' command and subsequently inspect at least sense byte 0 to find the reason for the unit check. The following text describes the suggested error recovery procedures for errors shown by bits set in sense byte 0.

Command Reject (Sense Byte 0, Bit 0)

The most likely cause of command reject being set is that a 'read' command has been issued. The operating system should trace back the program and provide a message advising the system programmer to correct the error.

Intervention Required (Sense Byte 0, Bit 1)

If the intervention required bit is set, the printer has lost its ready state and manual intervention is required. The operating system should analyze sense bytes 2 and 3 because these bytes contain error information not necessarily indicated by the 3203's indicator lights. If sense bytes 2 and 3 show the cause of the error, an appropriate message should then be issued to the operator advising him of the error and requesting him to press the printer's START key (to restore the ready state).

If the error is not obvious from the information in sense bytes 2 and 3, the message should advise the operator to check for the end of forms and for the indicator lights on the 3203 operator panel. These lights, as described below, can suggest the reason for the printer losing its ready state.

INTERLOCK Light On: The operator should close the train gate and make certain the lock lever is fully engaged. If this does not correct the error, the CE should be notified.

FORMS Light On: The operator should check whether new forms must be inserted or whether a forms jam has occurred. In case of end-of-forms, printing continues until the end-of-sheet code is found in the carriage control buffer. The operator must then insert new forms and press the 3203's START key. If the end of the forms has not been reached, the operator should check for a jam. If there is no obvious jam, the positioning of the forms should be checked to ensure that overprinting does not occur.

IBM 3203 Printer (cont'd)

CHECK Light On: An error has occurred either in the 3203 or in the control logic. Errors in the printer can be conditions such as a train sync check, any-hammer-on check, a carriage sync check, and so on.

Hardware malfunctions of this type may be overcome by pressing the 3203's START key. If possible, the operator should check that the condition which turned on the light did not cause incorrect printing or incorrect forms movement. In case of repeated hardware errors, CE attention is required.

Errors in the printer control logic may be checks such as subscan-ring check, chain buffer address register check, coil protect check, and so on. In any such case, the operating system should issue an appropriate message (based on the information in sense bytes 2 and 3) which advises the operator to restore the ready state by pressing the printer START key. The program should repeat the last operation or restart at a logical point. If errors that cause the CHECK light to go on persist, the CE should be notified.

STACKER Light On: The operator should remove the printed forms from the stacker, or clear the stacker jam. The stacker should then be readjusted, the START key pressed and operation continued. If the STACKER light comes on when the stacker is not full and no stacker jam has occurred, the CE should be notified.

Equipment Check (Sense Byte 0, Bit 3)

If the equipment check bit is set, the operating system should analyze the data provided by sense bytes 4 and 5, and issue a message to the operator advising him of the condition. The program should then retry the last command or display the last print line on the video display. Equipment check conditions are not usually so severe that a retry would be ineffective. However, if equipment check persists, the CE should be notified.

Data Check (Sense Byte 0, Bit 4)

If the data check bit is set, the print pattern sent to the 3203 cannot be printed with the train cartridge currently fitted. In this case, the train cartridge should be changed and the job should be repeated.

Train Buffer Parity Check (Sense Byte 0, Bit 5)

If the train buffer parity check bit is set, the operating system should display the last line to be printed and repeat the operation. If the error persists, the CE should be notified.

No Channel Found (Sense Byte 0, Bit 6)

If the no channel found bit is set, the carriage control buffer has been loaded with information that is not appropriate for the current program. The operating system should either reload the carriage buffer or issue a message that indicates what type of control information should be loaded. The operator may also be advised to check the forms on the printer to determine which control program is required.

Channel 9 (Sense Byte 0, Bit 7)

If the channel 9 bit is set, the operating system should take the appropriate action, depending on the use and meaning of channel 9. Setting of the channel 9 bit may indicate a programming error such as the wrong carriage control information for the current program.

IBM 3203 Printer (cont'd)

Unit Exception in CSW

If the unit exception bit is set, a channel 12 code was detected during spacing, and interpretation depends on the meaning which the programmer has assigned to channel 12.

For example, if channel 12 is used to signal the approaching end of a sheet, and the printed information is not yet complete, the program should branch to a routine that advances the paper to the beginning of a new sheet (for example, skip to channel 1, which is usually used to indicate the first line of a new sheet).

Channel Data Check in CSW

The channel data check bit is usually set as a result of an error in the data transferred (such as in a buffer load operation) between main storage and the printer attachment. The output at the printer is, however, unreliable and the operating system should either retry the operation or display the contents of the output area as it should have been printed. Retry should in any case be attempted. Repeated channel data checks require CE attention.

Channel Control Check in CSW

If the channel control check bit is set, the operation was either terminated or not started due to a severe error in the system. Retry should be attempted and, if unsuccessful, the CE should be notified.

IBM 3211 Printer

Source: GA24-3543 IBM 3211 Printer Component
Description and Operator's Guide

Error-Recovery Summary				
Sense Byte 0		Sense Byte 1		Probable Cause
Bit Pos	Name	Bit Pos	Name	
0	Command Reject			Invalid command
1	Intervention Required (Not Ready)	2	Print Quality	Platen failed to advance Ribbon motion & ribbon skew
		4	Forms Check	Jam or torn forms Channel 1 & end of forms Channel 1 & stacker full
		No	Interlock Bits Condition	Swing gate not latched Carriage stop/release off Train not positioned Stop key activated Vacuum check End of forms Stacker full Write after single cycle Train overload
2	Bus-out	Not CE & DE		Invalid parity on command
		CE & DE		Invalid parity on data xfer
3	Equipment Check	0	Command Retry	PLB parity check
		1	Print Check	Hammer fire check Sync check Coil protect
		2	Print Quality	Platen failed to advance Platen failed to retract Ribbon motion/skew
		3	Line Position	Carriage failed to move Carriage sequence Carriage stop
		6	Mechanical motion	Time-out Cancel
		No	Bits	Transparent sync checks Train overload
4	Data Check	1	Print Check	Non compare UCSB
		3	Line Position	Non compare FCB
5	Buffer Parity Check	0	Command Retry	Parity check UCSB
		3	Line Position	Parity check FCB
		No	Write Bits Command Complete	Parity check UCSB
		No	UCSB Read Bits Command	Parity check UCSB
			FCB Read Command	Parity check FCB
			PLB Read Command	Parity check PLB
6	Load Check			UCSB FCB
7	Channel 9			Normal occurrence
		5	CMD Suppressed	Interface disconnect

IBM 3211 Printer (Cont'd)

Train Overload

1. Press COVER RAISE.
2. Open the swing gate by pulling out on the swing-gate release lever.
3. Pull the separator-frame release lever and open the separator frame.
4. Push the train-incrementor button to reset the overload check and to move the train. If the train turns freely (judged by the force required to push the train-incrementor button), the cause of the overload condition may also have been cleared. Attempt to return the printer to normal operation.
5. If the train continues to turn with difficulty or does not move at all, remove the cartridge (see "3216 Cartridge Removal") and push the train-incrementor button. If the train drive turns freely, install another cartridge if available, return the printer to operation, and call for service on the faulty cartridge. If the train drive binds or does not turn at all, call your service representative.

Forms Jam

When forms are feeding improperly due to forms separation or disengagement from the feed pins, the printer stops, FORM CHECK turns on, and the printer cover opens.

1. Open the swing gate by pulling out on the swing-gate release lever.
2. Inspect the forms in the area of the print line. If forms are not separated or damaged and appear to be feeding properly, check for a paper chad or other debris covering the forms-sensing device in the lower tractor. This can cause a false indication. Also check the black strip on the separator frame opposite the forms-sensing device. A buildup of paper dust on the strip can cause a false check.
3. Remove separated or damaged forms and use steps 4 through 17 of the forms loading procedure to reload forms.
4. Press CHECK RESET and PRINTER READY, and restart your program.
5. Use steps 19 through 29 of the forms loading procedure (see source publication) to return the printer to operation. Stacker rate, adjustable shelf, and stacker roll adjustments may not be necessary.

Carriage Check

If carriage motion is incorrect, the printer stops with CARRIAGE CHECK on.

1. Press COVER RAISE.
2. Open the swing gate by pulling out on the swing-gate release lever.
3. Determine if the forms are in proper position for the next print line.
4. Reposition forms if necessary, and set up to restart the program from an appropriate point.
5. Close and latch the swing gate.
6. Press CHECK RESET and PRINTER READY.
7. If carriage checks continue, call your service representative.

Print Check

A print check is indicated by the printer stopping with PRINT CHECK on.

1. Press COVER RAISE.
2. Open the swing gate by pulling out on the swing-gate release lever.
3. Inspect the last two printed lines.
4. If the printing is incorrect, set up to restart your program from a point ahead of the incorrect lines.
5. When set up, or if the printing appears correct, close and latch the swing gate and press CHECK RESET.
6. Press PRINTER READY and restart your program.
7. If print checks continue, call your service representative.

Model 125 Operator Console Video Screen

Source: GA33-1509-0 System/370 Mod 125 Procedures

The Video Screen:

- Is a 15 in. video monitor.
- Is mounted on a separate table and can be rotated through 180°.
- Displays numeric characters, upper case alphabetic characters, and special symbols.
- Can be manually adjusted for intensity.
- Is equipped with a program-controlled audible alarm, which alerts the operator to messages requiring attention.

Display Format

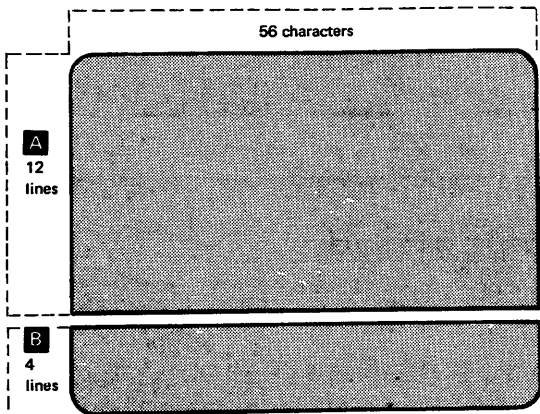

OS/VS Display Consoles

3277 and Model 158 Display Areas

Source: GC38-0260 OS/VS2 Display Consoles

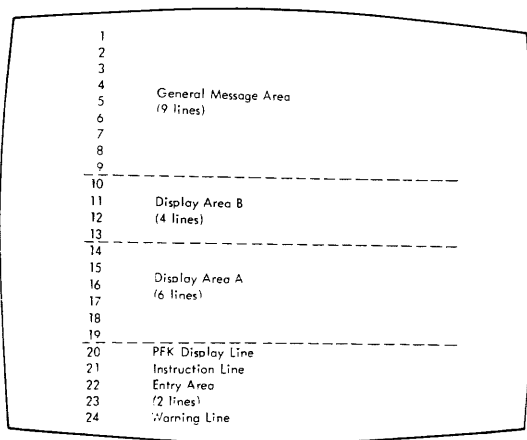

Model 168 Display Console Display Areas

Source: GC38-0260 OS/VS2 Display Consoles

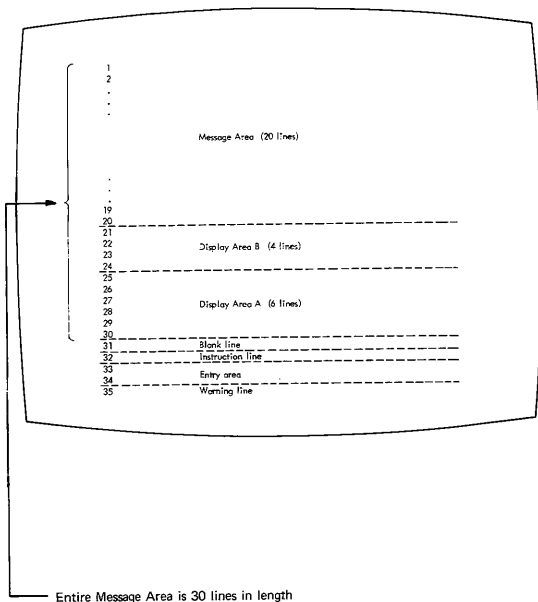

OS/VS Display Console Operation, Mod 158

Source: GC38-0260 OS/VS2 Display Consoles

How to Start the System Using the 3277

To start the system using the 3277 display console, follow the same procedure that you follow for a printer-keyboard console:

- Set the LOAD UNIT dials to the unit address of the SYSRES volume, and press the LOAD key on the control panel.
- Respond to the system parameter messages that appear on the screen.
- Set the time and date.
- Start the system input readers and output writers.
- Vary devices offline as appropriate.

The Model 158 display console does not have LOAD UNIT dials or a LOAD key. After typing in the load unit address or pointing to it with the light pen, the operator points the light pen to the LOAD and EXECUTE functions in that order, which accomplishes the load.

Error Conditions

Several types of errors may occur that directly affect the operation of display consoles—errors caused either by a programming problem (system error) or a console malfunction (hardware error).

System Errors

When certain types of system errors occur, the screen is blanked, and an error message appears in the center of the screen.

Blank Screen and Error Message

If the error message indicates that a recoverable system error has occurred, perform the action specified by the error message, and then press the CANCEL key. This should restore the screen.

If the error message indicates that an unrecoverable system error has occurred, the system must be loaded again. Follow normal procedures for initial program load (IPL), and notify the programmer responsible for the system.

Console Inactivity

Console inactivity is characterized by a lack of messages or system response to commands.

If your console seems to be abnormally inactive, check the system response by requesting a display of the time:

D T

If it does not respond, cancel any status displays being presented on the inactive console using the procedure for erasing a status display.

If neither of these procedures returns the console to normal activity, check for a console hardware error.

Display Console Operation, Mod 158 (cont'd)

Error Message Response

If a console hardware error occurs, the following message may appear on the screen:

```
IEE170E RETRYABLE ERROR. RECENT ACTION MAY NEED TO BE
      REPEATED. IEE170E PRESS THE CANCEL KEY TO RESTORE THE
SCREEN.
```

Perform the indicated action (press the CANCEL key). This should restore the screen, including messages displayed in the message area, the PFK display line, the instruction line, and the warning line.

Note: If you do not press the CANCEL key, the system will automatically rewrite the screen (same effect as CANCEL) after about 30 seconds have elapsed. If a console hardware error results from keyboard input, the system will always regard it as a temporary error. If it becomes apparent to you that the error is permanent, switch control to an alternate console (procedures for console switch are described in the Operator's Library *Reference* publication for the system you are using.)

Blank Screen Response

If the console screen goes blank, a console switch is probably taking place. The following message should appear on the new console:

```
IEE143I OLD=xxx, NEW=xxx, VALDCMD=xx
IEE143I ROUTCDE=xx[,xx] T=x H=x
```

In the actual message, the appropriate values will appear in place of the x's. Use the alternate console to continue operating the system, and have the old console checked for the source of the error.

NOTE: It is normal for the screen to go blank for a few seconds if the back-tab key is pressed when the cursor is not in the entry area.

Locked Keyboard Response

Sometimes the system is unable to blank the screen. If you find that you cannot enter commands through a console that appears normal, try to restore the screen by performing a CANCEL action.

If a console switch has taken place, operate the system from the alternate console, and have the old console examined for the source of the error.

NOTE: Inhibited input, with or without keyboard locking, may also occur when the system goes into an ABEND wait state or when a problem occurs in the message handling portion of the control program. Check the procedures described for console inactivity under "System Errors."

Operating the 3270

Source: *GA27-2742 Operator's Guide for IBM 3270
Information Display Systems*

Operating Procedure

General Instructions

1. Compose the test message. Write it on a slip of paper if helpful.
2. If necessary, apply power to the display station. Press the CLEAR key and then the RESET key. This will result in an unformatted screen with the cursor in the upper left screen position.
3. Enter the test message from the keyboard.
4. If the Dial feature is installed, call the computer operator and establish a phone connection as explained in the section "Dial Procedure".
5. Press the TEST REQ key and note that the INPUT INHIBITED indicator comes on.
6. Check that the test pattern you requested is received at the selected display station or printer. This completes the entry and replay for the first RFT message.

Note: To check the Basic Test Pattern, you must enter data from the keyboard. Also, if the display station is equipped with a selector pen, check selector pen operation at this time. A step-by-step explanation of how to check the Basic Test Pattern follows these general instructions.

7. Repeat steps 1 through 6 for each succeeding RFT message until you have completed the RFT series for your display or printer. As you enter a new RFT message, the only change in the message format from the preceding message is the test pattern identification number.
8. Compare the test pattern received with the correct pattern as you finish each test. If you do not receive a test pattern correctly, report it to your supervisor and, if consistent with organizational policy, fill out an OPERATOR TROUBLE REPORT.

Operator Trouble Report

POWER FAILURE

UNIT IDENTIFICATION _____

- Display station won't turn on.
- Display station was operating; went dead.
- Noticed smoke or unusual odor at the time.

FAILURE OF

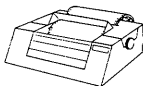

Printer



Selector Pen



Operator Identification Card Reader



Display Station
 DISCONNECT switch
(Dial Feature only)



Keyboard
 Keyboard and DISCONNECT switch both inoperative.
(Dial Feature only)

INDICATORS

Mark the indicators on when failure occurred.

- | | |
|--|---|
| <input type="checkbox"/> SYSTEM READY | <input type="checkbox"/> SYSTEM AVAILABLE |
| <input type="checkbox"/> SYNC SEARCH | <input type="checkbox"/> INSERT MODE |
| <input type="checkbox"/> SELECTED | <input type="checkbox"/> INPUT INHIBITED |
| <input type="checkbox"/> TRANSMIT | |
| <input type="checkbox"/> STATUS | |
| <input type="checkbox"/> OFF HOOK/AUTO ANSWER
(Dial Feature only) | |

One or more indicators:

- Light when they should not.
Don't light when they should.

DISPLAY FAILURE

The image on the screen looks like:



Cursor

- more than one cursor.
- won't move.
- is missing.
- is too short or too long.
- is normal but display is blank.
- is in wrong place (not below characters).

Nothing displays on screen:

- Is completely blank.
- Is glowing brightly.
- Image is too bright or too dim and cannot be adjusted.

Operating the 3270 (Cont'd)

Instructions for Checking Basic Test Pattern, EBCDIC No. 23 or ASCII No. 29

The display image should appear with the cursor located under the character C in the second row of displayed data. No indicators should be on.

1. Key in the row of alphabetic characters and the one space exactly as they appear in the row above. All characters should enter correctly, and cursor should move under I after Space bar is pressed.
2. Move cursor under C of CK in second row of displayed data, using → (right) key.
3. Press INS MODE key. INSERT MODE indicator should light.
4. Press A key. Field should now appear ACK.
5. Press FIELD MARK key. (Use B key on Operator Console keyboard.) Field should now appear A;CK (ABCK).
6. Press C key. The data should not change, but the INPUT INHIBITED indicator should come on (in addition to the INSERT MODE indicator, which has remained on).
7. Press RESET key. Both indicators should go out.
8. Press DEL key. The C should disappear, and the field should now appear A;K(ABK).
9. Press ← key (New Line). Cursor should move under C character in fourth row of displayed data.
10. Enter the special characters as they appear in the row above, shifting where required. Cursor should appear under O character after last special character entered.
11. Enter the digits 0 through 9 and the characters, . - and A as they appear in the row above. (On Data Entry keyboards, use the , over * and . over \$ keys to enter the , and . characters.) The following results should occur:
 - a. Typewriter and Operator Console keyboards without Numeric Lock feature — all characters should enter.
 - b. Data Entry keyboard without Numeric Lock feature — characters , and - enter normally; the A character enters as < symbol.
 - c. All keyboards with Numeric Lock feature — characters . and - enter normally; keyboard should lock and INPUT INHIBITED should light when , and A keys are pressed. (Use Reset and → keys to move cursor from those positions.)
12. Check ↑ (Up), ↓ (Down), and ← (Backspace) cursor move keys for proper operation.
13. Check the typamatic function of the Space bar or any other key with typamatic capability. Use the first field in the fourth row of displayed data for this step.
14. Move cursor under first character displayed of test message.
15. Press any alphameric key. INPUT INHIBITED indicator should come on, and character should not enter or display because field is designated as a protected data field.
16. Press RESET key. INPUT INHIBITED indicator should go out.
17. Press ENTER key. INPUT INHIBITED indicator should light, and keyboard should lock.
18. Press RESET key. INPUT INHIBITED indicator should go out, and keyboard should unlock.

NOTE: The following steps check tab, DUP, and new line functions.

19. Press → (Tab) key. Cursor should appear under character A in second row of characters.
20. Press DUP key. An asterisk (*) should appear in cursor position, and cursor should move under i of INSERT. (On Operator Console keyboard, use Tab key; cursor should move under I of INSERT, but the asterisk should not appear.)
21. Space one character position. The I should disappear.
22. Press ← (Backtab) key. Cursor should move back one space to where the I was formerly located.
23. Press Tab key. (Use SKIP key on Data Entry keyboards.) The cursor should appear in the first character position of the fourth row of displayed data.

Operating the 3270 (Cont'd)

NOTE: The following steps test the erase and clear functions.

24. Position cursor under character E in second row of displayed data.
25. Press ERASE EOF key. Characters E through Z should disappear, and cursor should not move.
26. Press ERASE INPUT key. All unprotected data, including keyed-in characters and field that originally appeared as INSERT CK should disappear from screen.
27. If display station being tested has a selector light-pen attached, continue with step 28. If a pen is not attached, press CLEAR key. All characters remaining on screen should disappear, and cursor should reappear in first character position in first row. Press RESET key, and enter the next test message (steps 1-7 of "General Instructions").
28. Fire pen on detectable field that has a question mark (?) as its first character. Question mark should change to a greater-than (>) symbol. Remainder of field should not change.
29. Fire pen again on the field. The greater-than symbol should change back to a question mark. Remainder of field should not change.
30. Fire pen on next detectable field that has a greater-than symbol as its first character. The greater-than symbol should change to a question mark. Remainder of field should not change.
31. Fire pen again on same field. Question mark should change back to a greater-than symbol. Remainder of field should not change.
32. Press CLEAR key. All characters on screen should disappear, and cursor should move to character location 0. Press RESET key, and enter the next test message (steps 1-7 of "General Instructions").

Section 6 Contents

Section 6:	6-1
DOS/VS System Utilities	6-1
Assign Alternate Track Data Cell	6-1
Clear Data Cell	6-1
Clear Disk	6-1
Copy and Restore Disk or Data Cell	6-1
Copy and Restore Diskette	6-2
Deblock	6-2
Fast Copy Disk Volume	6-2
Fast Copy Stand-Alone Version	6-2
Initialize Data Cell	6-2
Initialize Disk	6-2
Initialize Tape	6-2
Print Hardcopy File	6-3
VTOC Display	6-3
DOS DITTO	6-3
Sample Control-Statement Streams for:	
Initialize Data Cell	6-4
Initialize Disk	6-4
Initialize Tape	6-4
Fast Copy Disk Volume	6-5
Printlog	6-5
VTOC Display	6-5
FDP: DITTO	6-6
OS/VS Utilities	6-7
System Utilities Programs	6-7
Data Set Utility Programs	6-7
Independent Utility Programs	6-8
Index of Functions Performed by Utility Programs	6-9
Executing a System Utility Program	6-12
Sample Control-Statement Streams for:	
IBCDASDI	6-14
IEHDASDR	6-14
IEBISAM	6-15
IEHLIST	6-15
IEHMOVE	6-16
IEBPTCH	6-16
DOS/VS Service Aids	6-18
RJE I/O Trace	6-18
POWER/VS File Dump Program	6-18
OS/VS1 Service Aids	6-20
Executing SADMP	6-21
Executing PRDMP	6-22
OS/VS1 OLTEP	6-24

DOS/VS System Utilities

Source: GC33-5381 "DOS/VS System Utilities, Release 33"

This section contains information on a few of the frequently used DOS Utility programs. Refer to the SRL for complete information.

Assign Alternate Track Data Cell

Purposes:

- To assign an alternate track on an IBM 2321 Data Cell Drive. If an alternate track is found defective, a new alternate track must be assigned to the primary track.
- To recopy data from the alternate track to the primary track if this track is no longer defective.
- To replace bad records on a specified track if update records are supplied as input.

Assign Alternate Track Disk

Purposes:

- To assign an alternate track on an IBM 2311 Disk Storage Drive, an IBM 2314 Direct Access Storage Facility, an IBM 2319 Disk Storage, an IBM 3330 Disk Storage, an IBM 3333 Disk Storage, or an IBM 3340 Direct Access Storage Facility, and to copy data (if present) from a defective track to an alternate track.

If an alternate track is found to be defective, a new alternate track must be assigned to the primary track.

To replace bad records on a specified track if update records are supplied as input.

- To change the track-condition indication, and to recopy data (if present) from the alternate track to the primary track.

Restriction: This is only valid for the 2311, the 2314, and 2319.

Clear Data cell

Purposes:

- To clear one or more areas on an IBM 2321 Data Cell Drive.
- To establish preformatted tracks throughout the area cleared.
- To create a file label in the VTOC.

Clear Disk

Purposes:

- To establish preformatted tracks (clear) on one or more extents on an IBM 2311 Disk Storage Drive, an IBM 2314 Direct Access Storage Facility, an IBM 2319 Disk Storage, an IBM 3330 Disk Storage, an IBM 3333 Disk Storage, or an IBM 3340 Direct Access Storage Facility.
- To create a file label in the VTOC.

Copy and Restore Disk or Data Cell

Purposes:

- To copy a volume or file from an IBM 2311 Disk Storage Drive, an IBM 2314 Direct Access Storage Facility, an IBM 2319 Disk Storage, an IBM 3330 Disk Storage, an IBM 3333 Disk Storage, or an IBM 3340 Direct Access Storage Facility, to cards, disk, or tape.
- To copy a volume or file from an IBM 2321 Data Cell Drive to tape.
- To restore data to disk or data cell at a later date.

DOS/VS System Utilities

Copy and Restore Diskette

Purposes:

- To replace bad labels on an IBM 3540 Diskette Input/Output Unit.
- To copy the entire contents of a diskette onto another diskette.
- To eliminate the special records from all data files.
- To create a backup copy.

Deblock

Purposes:

- To block an 80/81-byte record file to a 3440-byte record file.
- To deblock a blocked 3440-byte file in order to create an 80-byte SYSIN file.
- To copy files.
- To print (list) job control statements and comments from a blocked input file.
- To select records (or a group of records) from a blocked 3440-byte file in order to create an 80-byte SYSIN file.

Fast Copy Disk Volume

- To copy the entire contents of an IBM 3330 Disk Storage, an IBM 3333 Disk Storage, or an IBM 3340 Direct Access Storage Facility onto another disk device of the same type in a short time. The pack to be copied may contain any combination of DOS/VS data sets and system components.

The contents of this disk may be copied directly to another disk device, or it may be written on magnetic tape, to be restored at a later time.

Initialize Data Cell

Purpose:

- To prepare from one to five new or expired cells for use on an IBM 2321 Data Cell Drive.

Initialize Disk

Purpose:

- To prepare one complete disk pack for use on an IBM 2311 Disk Storage Drive, an IBM 2314 Direct Access Storage Facility, an IBM 2319 Disk Storage, an IBM 3330 Disk Storage, an IBM 3333 Disk Storage, or an IBM 3340 Direct Access Storage Facility.

The program can also be used:

- To change the volume label(s) and the VTOC (volume table of contents) address of a previously initialized disk pack (other than an emulator pack).

If you specify IS in the input option parameter of the utility modifier statement, surface analysis, HA (home address), and RO (track descriptor record) generation are bypassed. This option assumes that a valid VTOC is present. A workpack used for OS can therefore be converted into a workpack suitable to be used for DOS/VS.

Initialize Tape

Purposes:

- To write one to eight IBM standard tape volume labels in numerical sequence, followed by one dummy header label and one tapemark on EBCDIC tapes.

DOS/VS System Utilities

Print Hardcopy File (Printlog) — Models 115 and 125

Purpose:

- To print on SYSLST the hardcopy file from an IBM 3330 Disk Storage, an IBM 3333 Disk Storage, or an IBM 3340 Direct Access Storage Facility.

VTOC Display

Purpose:

- To display the labels contained in the VTOC of a disk pack on an IBM 2311 Disk Storage Drive, an IBM 2314 Direct Access Storage Facility, an IBM 2319 Disk Storage, an IBM 3330 Disk Storage, an IBM 3333 Disk Storage, an IBM 3340 Direct Access Storage Facility, or of a data cell on an IBM 2321 Data Cell Drive.

Field Developed Program

DOS/DITTO (Program No. 5798-ARN)

Purpose:

- DOS/DITTO is a general-purpose utility program containing 37 utility functions for Unit Record, Tape, and Disk I/O units.

FAST COPY STAND-ALONE VERSION

This program is distributed in card-image format in the DOS/VS source statement library. It is cataloged in the sublibrary designated Z under the book name FASTCOPY.

The phase name, used as the operand of the EXEC job control card, is FCOPY.

This program can be punched into cards by submitting a DOS/VS job made up of these statements.

```
// JOB PUNCH STAND ALONE FAST COPY DECK
// ASSGN SYSPCH,X'00D' (see Note)
// EXEC SSERV
  PUNCH Z.FASTCOPY
/*
/&
// PAUSE REMOVE FIRST 2 AND
  LAST 2 CARDS FROM PUNCHED DECK
```

NOTE: Assign SYSPCH to a card punch device. Include ASSGN statements for SYSIPT, SYSLST, and SYSLOG if the current assignments are not those required.

The first two cards of the punched deck contain CATALS and BKEND in the first punched positions. The last two cards contain BKEND and /*. All four cards should be removed before the stand-alone card deck is used.

DOS/VS System Utilities

UTILITY PROGRAMS – CONTROL STATEMENT STREAMS

Parts in boldface are invariable. Replace light type as required by your application. Refer to GC33-5381 for a description of parameters and utility function codes.

INITIALIZE DATA CELL

```
// JOB INITIAL
// ASSIGN SYS000,X'293'
// EXEC INTDC
// UIM CELLS=(3,5,7)
// VTOC STRTADR=(3033303),EXTENT=(5)
VOL1222222
// END
// VTOC STANDARD
VOL1333333
// END
// VTOC STANDARD
VOL1444444
// END
/ &
```

INITIALIZE DISK

```
// JOB INITIAL
// ASSGN SYS000,X'191'
// EXEC INTDK
// UID IR,C1,R=(0027003) (not valid for 3330/3333)
// VTOC STANDARD
VOL1111111
// END
/ &
```

NOTE: When you initialize an IBM 2311, 2314 or 2319 disk pack to be used as a stacked disk pack by the 1401/1440 System/370 Emulators (program number SCEML 5745); you must include an UPSI card immediately before the EXEC card in the control statement stream. This UPSI card must have the following format:

```
// UPSI 0000001
```

This card allows cylinder 200 to be used for emulator data instead of being part of the alternate track area.

Restriction: You cannot use the UPSI card for the IBM 3330, 3333, and 3340.

INITIALIZE TAPE

This job stream is used to initialize an ASCII tape without the card image option.

```
// JOB INITIAL
// ASSGN SYS000,X'181'
// ASSGN SYS001,UA (no checkpoints)
// EXEC INTTP
// INTT REWIND,A,SERIAL=(000001),P=(1),
CODE=(AB COMPANY NYC)
/ &
```

DOS/VS System Utilities

This job stream is used to initialize an ASCII tape with the card image option.

```
// JOB INITIAL
// ASSGN SYS000,X'181'
// ASSGN SYS001,X'182'
// ASSGN SYS002,UA (no checkpoints)
// EXEC INTTP
// INTT CARD, A (column 80)
VOL1000001 AB COMPANY NYC 1
// END
VOL1000002 AB COMPANY NYC 1
// END
/;&
```

It is assumed that in each example SYSLOG is permanently assigned.

FAST COPY DISK VOLUME

1. Copy Disk to Disk

```
// JOB COPY 3330 to 3330
// ASSGN SYS004,X'160' (input disk)
// ASSGN SYS005,X'161' (output disk)
// EXEC FCOPY,REAL
// UDD IV=DOSR29
/;&
```

2. Copy Disk to Tape

```
// JOB COPY 3340 TO TAPE
// ASSGN SYS004,X'160' (input disk)
// ASSGN SYS005,X'280' (output tape)
// ASSGN SYS005,X'281',ALT (alternate tape)
// TLBL UOUT,'BACKUP TAPE'
// EXEC FCOPY,REAL
// UDT IV=111111
/;&
```

3. Copy Tape to Disk

```
// JOB RESTORE BACKUP TAPE TO DISK
// ASSGN SYS004,X'280' (input tape)
// ASSGN SYS004,X'281',ALT (alternate tape)
// ASSGN SYS005,X'160' (output disk)
// TLBL UIN,'BACKUP TAPE'
// EXEC FCOPY,REAL
// UTD
/;&
```

PRINTLOG

```
// JOB NAME
// EXEC PRINTLOG
```

VTOC DISPLAY

```
// JOB VTOC
// ASSGN SYS004,X'191'
// ASSGN SYS005,X'00E'
// PAUSE REPLY NO IF MSG 8V96D IS ISSUED
// EXEC LVTOC
/;&
```

It is not necessary to use a utility modifier card for the VTOC display program.

Ditto is a self-prompting conversational program. The DITTO utility can be executed from cards or at the console. To execute DITTO from the console, enter:

```
// JOB Anyname
// EXEC DITTO
```

The program responds with: DITTO FUNCTION.

Type the appropriate utility function code. If you are at a console and don't know the function code, type xxx in response to the DITTO FUNCTION message. You will get this list of DITTO functions and their function codes.

DOS/DITTO

Function

Codes

Card Functions

CC	CARD TO CARD
CCS	CARD TO CARD WITH SEQ. NUMBERS AND DECK NAME
CP	CARD TO PRINTER IN CHARACTER FORMAT
CD	CARD TO PRINTER IN CHARACTER AND HEX DUMP FORMAT
CT	CARD TO TAPE BLOCKED 1 TO 400
CTS	CARD TO TAPE RESEQUENCED

Tape Functions

TC	TAPE TO CARD BLOCKED OR UNBLOCKED
TP	TAPE TO PRINTER UNBLOCKED IN CHAR. FORMAT
TPD	TAPE TO PRINTER DEBLOCKED IN CHAR. FORMAT
TD	TAPE TO PRINTER UNBLOCKED IN CHAR. AND HEX DUMP
TDD	TAPE TO PRINTER DEBLOCKED IN CHAR. AND HEX DUMP
TPV	TAPE TO PRINTER VARIABLE RECDs CHAR. FORMAT
TDV	TAPE TO PRINTER VARIABLE RECDs CHAR. AND HEX DUMP
TFA	PRINT SYSLST TAPES TYPE A FORMS CONTROL, CCW CODE
TFD	PRINT SYSLST TAPES TYPE D FORMS CONTROL
TRS	TAPE RECORD SCAN
TRL	TAPE RECORD LOAD
INT	INITIALIZE TAPE
TT	TAPE TO TAPE (01 to 99) FILES
TTR	TAPE TO TAPE REBLOCKED
WTM	WRITE TAPE MARK
REW	REWIND TAPE
RUN	REWIND AND UNLOAD TAPE
FSR	FORWARD SPACE RECORD
BSR	BACK SPACE RECORD
FSF	FORWARD SPACE FILE
BSF	BACK SPACE FILE
ERT	ERASE TAPE (DATA SECURITY ERASE 3410/3420 ONLY)

Disk Functions

DP	DISK TO PRINTER UNBLOCKED IN CHAR. FORMAT
DD	DISK TO PRINTER UNBLOCKED IN CHAR. AND HEX DUMP
DPD	DISK TO PRINTER DEBLOCKED IN CHAR. FORMAT
DDD	DISK TO PRINTER DEBLOCKED IN CHAR. AND HEX DUMP
DRL	DISK RECORD LOAD - KEY AND/OR DATA
DRS	DISK RECORD SCAN - PARTIAL KEY OR DATA OR EOF
EOF	WRITE DISK EOF RECORD
DID	ALTER DISK IDENTIFICATION VOLUME NUMBER
XXX	LIST FUNCTIONS ON SYSLST
EOJ	END OF JOB

If the function involves tape, the DITTO program will request the input and output drive numbers and the number of files. If it is a disk to printer function, the DITTO program will ask you to identify the disk by number.

When the function is completed, DITTO again types: DITTO FUNCTION.
Type in another utility code, or EOJ if finished with DITTO.

OS/VS Utilities

Source: *GC35-0005 OS/VS Utilities*

System Utility Programs

System utility programs manipulate collections of data and system control information. The system utility programs are:

- IEHATLAS, which is used to assign alternate tracks when defective tracks are indicated.
- IEHDASDR, which is used to initialize direct access volumes or to dump or restore data.
- IEHINITT, which is used to write standard labels on tape volumes.
- IEHIOSUP, which is used to update entries in the supervisor call library (VS1 only).
- IEHLIST, which is used to list system control data.
- IEHMOVE, which is used to move or copy collections of data.
- IEHPROGM, which is used to build and maintain system control data.
- IEHUCAT, which is used to update an OS catalog to the level of a VSAM catalog (non-VSAM data sets). (VS1 only)
- IFHSTATR, which is used to select, format, and write information about tape errors from the IFASMFDL tape or the SYS1.MAN data set.

A system utility program is executed or invoked through the use of job control statements and utility control statements.

DATA SET UTILITY PROGRAMS

Data set utility programs manipulate partitioned, sequential, or indexed sequential data sets provided as input to the programs. Data ranging from fields within a logical record to entire data sets can be manipulated. The data set utility programs are:

- IEBCOMPR, which is used to compare records in sequential or partitioned data sets.
- IEBCOPY, which is used to copy, compress, or merge partitioned data sets, to select or exclude specified members in a copy operation, and to rename and/or replace selected members of partitioned data sets.
- IEBDG, which is used to create a test data set consisting of patterned data.
- IEBEDIT, which is used to selectively copy job steps and their associated JOB statements.
- IEBGENER, which is used to copy records from a sequential data set or to convert a data set from sequential organization to partitioned organization.
- IEBISAM, which is used to place source data from an indexed sequential data set into a sequential data set in a format suitable for subsequent reconstruction.
- IEBPTPCH, which is used to print or punch records that reside in a sequential or partitioned data set.
- IEBTCRIN, which is used to construct records from the input data stream that have been read from the IBM 2495 Tape Cartridge Reader.
- IEBUPDTE, which is used to incorporate changes to sequential or partitioned data sets.

Data Set utility programs can be executed as jobs or can be invoked as subroutines by a calling program.

OS/VS Utilities

INDEPENDENT UTILITY PROGRAMS

Independent utility programs operate outside, and in support of, the operating system. They are not supported, however, by the 3066 console, which is only used with the Model 165, System/370. If the 3066 is the only console available, execute independent utilities by following step 3b "Executing IDCASDI and IBCDMPRS" below. The independent utility programs are:

- IBCDASDI, which is used to initialize a direct access volume and to assign alternate tracks.
- IBCDMPRS, which is used to dump and restore the data contents of a direct access volume.
- ICAPRTBL, which is used to load the forms control and Universal Character Set buffers of a 3211 after an unsuccessful attempt to IPL, with the 3211 printer assigned as the output portion of a composite console.

Guide to Utility Program Functions

Source: GC35-0005-2 OS/VS Utilities

This table shows a list of tasks that the utility programs can be used to perform. The left-hand column shows tasks that you might want to perform. The middle column defines the tasks more specifically. The right-hand column shows the utility programs that can be used for each task. Notice that in some cases more than one program may be available to perform the same task.

TASKS AND UTILITY PROGRAMS

Task	Utility Program
Add	a password IEHPROGM
Analyze	tracks on direct access IEHATLAS,IEHDASDR,IBCDASDI
Assign alternate tracks	to a direct access volume IEHATLAS,IEHDASDR,IBCDASDI
Build	a generation index VS1 ONLY—IEHPROGM
	a generation VS1 ONLY—IEHPROGM
	an index VS1 ONLY—IEHPROGM
Catalog	a data set IEHPROGM
	a generation data set VS1 ONLY—IEHPROGM
Change	data set organization IEBUPDTE
	logical record length IEBGENER
	volume serial number of direct access volume IEHDASDR
Compare	a partitioned data set IEBCOMPR
	sequential data sets IEBCOMPR
Compress-in-place	a partitioned data set IEBCOPY
Connect	volumes VS1 ONLY—IEHPROGM
Construct	records from MTST and MTDI input IEBTSCRIN
Convert to partitioned	a sequential data set created as a result of an unload IEBCOPY
	sequential data sets IEBUPDTE,IEBGENER
Convert to sequential	a partitioned data set IEBUPDTE,IEBCOPY
	an indexed sequential data set IEBISAM,IEBDG
Copy	a catalog VS1 ONLY—IEHMOVE
	a direct access volume IEHDASDR,IBCDMPRS,IEHMOVE
	a partitioned data set IEBCOPY,IEHMOVE
	a volume of data sets IEHMOVE
	an indexed sequential data set IEBISAM
	cataloged data sets VS1 ONLY—IEHMOVE
	dumped data from tape to direct access IEHDASDR,IBCDMPRS
	job steps IEBEDIT
	members IEBGENER,IEBUPDTE,IEBDG
	selected members IEBCOPY,IEHMOVE
	sequential data sets IEBGENER,IEHMOVE,IEBUPDTE
	to tape IBCDMPRS
Create	a library of partitioned members IEBUPDTE
	a member IEBDG
	a sequential output data set IEBDG
	an index VS1 ONLY—IEHPROGM
	an output job stream IEBEDIT
Delete	a password IEHPROGM
	an index structure VS1 ONLY—IEHPROGM
	records in a partitioned data set IEBUPDTE
Dump	a direct access volume IEHDASDR,IBCDMPRS
Edit	MTDI input (Magnetic Data Inscriber) IEBTSCRIN
Edit and convert to partitioned	a sequential data set IEBGENER,IEBUPDTE
Edit and copy	a job stream IEBEDIT
	a sequential data set IEBGENER,IEBUPDTE
Edit and list	error statistics by volume (ESV) records IEHSTATR
Edit and print	a sequential data set IEBPTPCH
Edit and punch	a sequential data set IEBPTPCH
Enter	a procedure into a procedure library IEBUPDTE
Exclude	a partitioned data set member from a copy operation IEBCOPY,IEHMOVE

Guide to Utility Program Function

Task	Utility Program
Expand	a partitioned data set IEBCOPY a sequential data set IEBGENER test data IEBDG
Generate	
Get alternate tracks	on a direct access volume IEHDASDR,IBCDASDI,IEHATLAS
Include	changes to members or sequential data sets IEBUPDTE
Initialize	a direct access volume IEHDASDR,IBCDASDI
Insert records	into a partitioned data set IEBUPDTE
Label	magnetic tape volumes IEHINITT
List	a password entry IEHPROGM a volume table of contents IEHLIST contents of direct access volume on system output device IEHDASDR number of unused directory blocks and tracks IEBCOPY partitioned directories IEHLIST the contents of the catalog (SYSCTLG data set) VS1 ONLY-IEHLIST
Load	a previously unloaded partitioned data set IEBCOPY an indexed sequential data set IEBISAM an unloaded data set IEHMOVE UCS and FCB buffers of a 3211 ICAPRTBL
Merge	partitioned data sets IEHMOVE,IEBCOPY
Modify	a partitioned or sequential data set IEBUPDTE
Move	a catalog VS1 ONLY-IEHMOVE a volume of data sets IEHMOVE cataloged data sets VS1 ONLY-IEHMOVE partitioned data sets IEHMOVE sequential data sets IEHMOVE
Number records	in a new member IEBUPDTE in a partitioned data set IEBUPDTE
Password protect	add a password IEHPROGM delete a password IEHPROGM list passwords IEHPROGM replace a password IEHPROGM
Print	a sequential data set IEBCOPY,IEBUPDTE,IEBPTPCH partitioned data sets IEBPTPCH selected records IEBPTPCH
Punch	a partitioned data set member IEBPTPCH a sequential data set IEBPTPCH selected records IEBPTPCH
Read	Tape Cartridge Reader input IEBCRIN
Reblock	a partitioned data set IEBCOPY a sequential data set IEBCOPY,IEBUPDTE
Recover	data from defective tracks on direct access volumes IEHATLAS
Release	a connected volume VS1 ONLY-IEHPROGM
Rename	a partitioned data set member IEBCOPY,IEHPROGM a sequential or partitioned data set IEHPROGM moved or copied members IEHMOVE
Renumber	logical records IEBUPDTE
Replace	a password IEHPROGM data on an alternate track IEHATLAS identically named members IEBCOPY logical records IEBUPDTE members IEBUPDTE records in a member IEBUPDTE records in a partitioned data set IEBUPDTE,IEBCOPY selected members IEBCOPY selected members in a move or copy operation IEBCOPY,IEHMOVE

OS/VS Utilities

Task		Utility Program
Restore	a dumped direct access volume from tape	IBCDMPRS,IEHDASDR
Scratch	a volume table of contents data sets	IEHPROGM IEHPROGM
Uncatalog	data sets	IEHPROGM
Unload	a partitioned data set	IEHMOVE,IEBCOPY
	a sequential data set	IEHMOVE
	an indexed sequential data set	IEBISAM
Update	a catalog to VS2 Release 2 level	VS1 ONLY—IEHUCAT
	in place a partitioned data set	IEBUPDTE
	TTR entries in the supervisor call library	IEHIOSUP
Write	IPL records and a program on a direct access volume	IBCDASDI,IEHDASDR

OS/VS EXECUTING A SYSTEM UTILITY PROGRAM

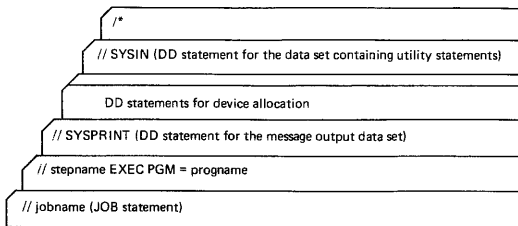

OS/VS UTILITY CONTROL CARD EXAMPLES

1. Card to print

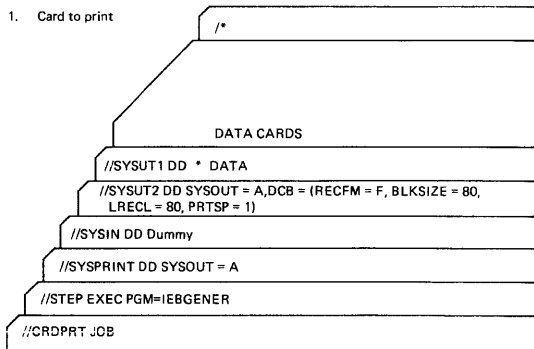

Notes: Place a blank care in front of data cards to prevent overprinting of first card.

OS/VS UTILITY CONTROL CARD EXAMPLES

2. Card to tape

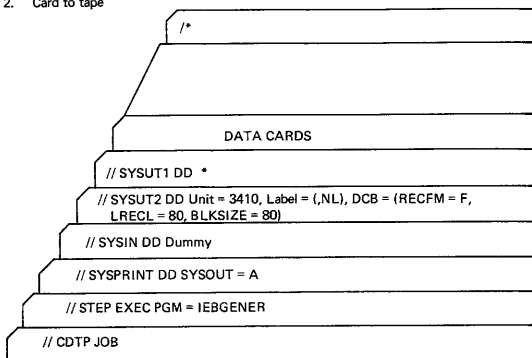

Notes: Variations in tape unit or label information must be accounted for in sysUT2 card. Blocking may be specified by RECFM = FB or VB and increasing blksize to some multiple of LRECL.

3. System list

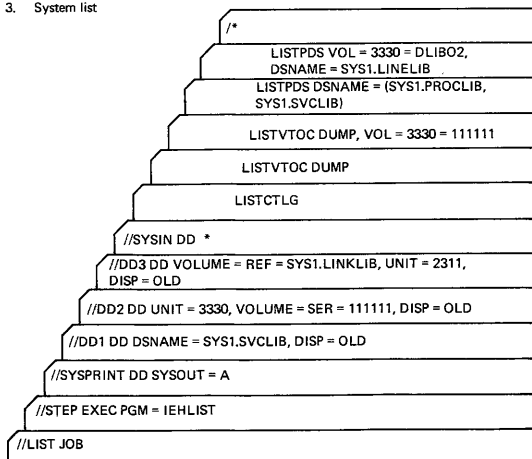

Sample Control-Statement Streams

Source: *GC35-0005 OS/VS Utilities*

A few examples of utility functions and the control statements that must be prepared to execute them follow.

IBCDASDI

In this example, a 3330 volume is initialized for later use as a system residence volume. An IPL program is included in standard TXT format.

The example follows:

```
INIT      JOB 'INITIALIZE 3330'
          MSG TODEV=1403,TOADDR=00E
          DADEF TODEV=3330,TOADDR=150,IPL=YES
          VLD  NEWVOLID=P10000,OWNERID=BROWN,ADDLABEL=2
          VTOCD STRTADR=2,EXTENT=7
          IPLTXT
```

(IPL program text statements)

```
END
```

The control statements are discussed below:

- DADEF specifies that a 3330 volume is to be initialized and specifies the channel number and unit number. An IPL program is to be included.
- VLD specifies a volume serial number and owner identification for the volume to be initialized. It also specifies that space is to be allocated for two additional labels.
- VTOCD specifies that the volume table of contents is to begin on track 2 and is to extend over nine tracks.
- IPLTEXT specifies the beginning of IPL program text statements.
- END specifies the end of IPL program text statements. Because IPL text is included, END begins in column 2.

IEHDASDR

In this example, alternate tracks are to be assigned for three suspected defective tracks on a 3330 volume.

The example follows:

```
//DASDR3  JOB
//          EXEC   PGM=IEHDASDR
//SYSPRINT DD   SYSOUT=A
//VOLUME1 DD   UNIT=(3330,,DEFER),DISP=OLD,
// VOLUME=(PRIVATE,,SER=(333000))
//SYSIN    DD    *
          GETALT  TODD=VOLUME1,TRACK=00050011
          GETALT  TODD=VOLUME1,TRACK=00A00007
          GETALT  TODD=VOLUME1,TRACK=01010002
          LABEL   TODD=VOLUME1,NEWVOLID=DISK00,OWNERID=SMITH
/*
```

The control statements are discussed below:

- VOLUME1 DD defines a device that is to contain the 3330 volume (333000).
- SYSIN DD defines the control data set, which follows in the input stream.
- The GETALT statements specify the ddname of the DD statement defining the device on which the 3330 volume is mounted. The GETALT statements specify the relative track addresses of the tracks for which alternates are to be assigned.

Sample Control-Statement Streams

- LABEL specifies the ddname of the DD statement defining the device on which the 3330 volume is mounted. The LABEL statement changes the serial number of the 3330 volume from 333000 to DISK00.

NOTE: With 3158 in Display mode, to get utilities SADUMP, IBCDASDI, IBCDASDR to work, you must re-IMPL and put console in PRINTER-KBD mode.

IEBISAM

In this example, an unloaded data set is to be converted to the form of the original indexed sequential data set.

The example follows:

```
//STEPS      JOB      09#770,SMITH
//          EXEC      PGM=IEBISAM,PARM=LOAD
//SYSPRINT   DD      SYSOUT=A
//SYSUT1     DD      DSNAME=INDSEQ,DISP=(,KEEP),DCB=(DSORG=IS),
// DISP=(OLD,KEEP),VOLUME=SER=001234
//SYSUT2     DD      DSNAME=INDSEQ,DISP=(,KEEP),DCB=(DSORG=IS),
// SPACE=(CYL,(1)),VOLUME=SER=111112,UNIT=2314
/*
```

The control statements are discussed below:

- EXEC specifies the program name and the LOAD operation.
- SYSUT1 DD defines the input data set, which is a sequential (unloaded) data set. The data set is the second data set on a 9-track tape volume.
- SYSUT2 DD defines the output data set, which is an indexed sequential data set. One cylinder of space is allocated for the data set on a 2314 volume.

IEHLIST

In this example, a volume table of contents, in edited form, is to be listed. The edited listing is supplemented by an unedited listing of selected data set control blocks.

The example follows:

```
//LISTVTOC   JOB      09#550,BLUE
//          EXEC      PGM=IEHLIST
//SYSPRINT   DD      SYSOUT=A
//DD2       DD      UNIT=2314,VOLUME=SER=231400,DISP=OLD
//SYSIN     DD      *
           LISTVTOC   FORMAT,VOL=2314=231400
           LISTVTOC   DUMP,VOL=2314=231400,DSNAME=(SET1,SET2,SET3)
/*
```

The control statements are discussed below:

- DD2 DD defines a mountable device on which the volume containing the specified volume table of contents is to be mounted.
- SYSIN DD defines the control data set which follows in the input stream.
- The first LISTVTOC statement indicates that the volume table of contents on the specified 2314 volume is to be listed in edited form.
- The second LISTVTOC statement indicates that the data set control blocks representing data sets SET1, SET2, and SET3 are to be listed in unedited form.

Sample Control-Statement Streams

IEHMOVE

In this example, a volume of data sets is to be moved to a 2314 volume. All data sets that are successfully moved are scratched from the source volume; however, any catalog entries pertaining to those data sets are not changed. Space is allocated by IEHMOVE. The work data set is deleted when the job step is completed.

The example follows:

```
//MOVEVOL JOB      09#550,GREEN
//          EXEC    PGM=IEHMOVE
//SYSPRINT DD      SYSOUT=A
//SYSUT1   DD      UNIT=2314,VOLUME=SER=231400,DISP=OLD
//DD1      DD      UNIT=3330,VOLUME=SER=111111,DISP=OLD
//DD2      DD      UNIT=2314,VOLUME=SER=231400,DISP=OLD
//DD3      DD      UNIT=2314,VOLUME=SER=231401,DISP=OLD
//SYSIN    DD      *
          MOVE     VOLUME=2314=231401,TO=2314=231400,PASSWORD
/*
```

The control statements are discussed below:

- SYSUT1 DD defines the device that is to contain the work data set. The work data set is removed from the receiving volume when the job step is completed.
- DD1 DD defines the system residence device.
- DD2 DD defines the mountable device on which the receiving volume is to be mounted.
- DD3 DD defines a mountable device on which the source volume is to be mounted.
- SYSIN DD defines the control data set, which follows in the input stream.
- MOVE specifies a move operation for a volume of data sets and defines the source and receiving volumes. This statement also indicates that password-protected data sets are to be included in the operation.

NOTE: IEHPROGRAM can be used to uncatalog catalog entries pertaining to source data sets and to catalog the moved versions of those data sets.

IEBTPCH

In this example, a sequential data set is to be punched according to standard specifications. The input data set resides on a 7-track tape volume, originally written at a density of 556 bits per inch. The punched output is converted to hexadecimal.

The example follows:

```
//PUNCHSET JOB      09#660,SMITH
//          EXEC    PGM=IEBTPCH
//SYSPRINT DD      SYSOUT=A
//SYSUT1   DD      DSNAME=INSET,UNIT=2400,VOLUME=SER=001234,
// LABEL=(,NL),DISP=(OLD,KEEP),DCB=(DEN=1,RECFM=FB,
// LRECL=80,BLKSIZE=2000,TRTCH=C)
//SYSUT2   DD      UNIT=2540-2
//SYSIN    DD      *
          PUNCH   TOTCONV=XE
          TITLE   ITEM=('PUNCH SEQ DATA SET WITH CONV TO HEX', 10)
/*
```

The control statements are discussed below:

- SYSUT1 DD defines the input data set. The data set contains 80-byte, fixed blocked records.

Sample Control-Statement Streams

- SYSUT2 DD defines the output data set. The data set is to be punched by an IBM 2540-2 Card Read Punch (punch feed). Each record from the input data set is represented by two punched cards.
- SYSIN DD defines the control data set, which follows in the input stream. The control data set contains the PUNCH and TITLE statements.
- PUNCH initiates the punch operation and specifies conversion from alphanumeric to hexadecimal representation.
- TITLE specifies a title to be placed beginning in column 10. The title is not converted to hexadecimal.

DOS/VS Service Aids

Source: SY33-8572 DOS/VS Handbook, Vol. 2, Release 31

RJE I/O TRACE

An I/O trace for an RJE line after SIGNON can be initiated by specifying YES to TRACE=in the PRMT macro.

Entries are made in a wraparound buffer in the phase IPW\$STM. The following information is recorded at every I/O interrupt from this terminal.

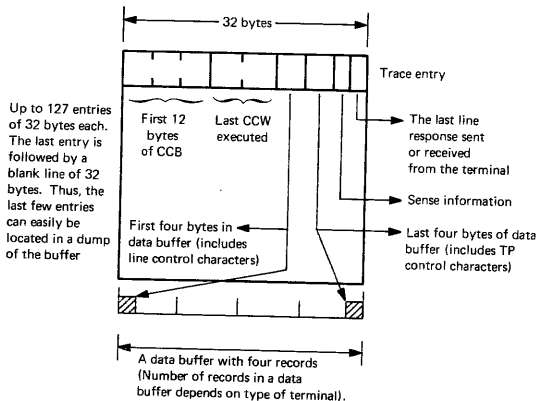

The trace is to be used when RJE line errors occur or incorrect output is encountered which can be caused by the I/O operation.

POWER/VS FILE DUMP PROGRAM

This program enables any of the POWER/VS files (account, queue, data) to be dumped on a line printer assigned to SYSLST. An option is also provided to enable queue records and their associated track groups belonging to specific jobs to be dumped.

How to Execute

The program is requested by JCL commands entered either via SYSLOG or SYSIN, where SYSIN is assigned to a card reader. Before requesting ensure relevant assignments are made for the file to be dumped.

Example Job Stream

```
//JOBname
//ASSGN (SYS000   for Account file)
        (SYS001   for Queue file)
        (SYS002-6 for Data files)
//EXEC IPW$DD
```

When the program is loaded successfully, the following message will be issued to SYSLOG:

DUMP FUNCTION=

DOS/VS Service Aids

At this point one of the following options can be entered via SYSLOG:

A (to specify the Account file)

Q (to specify the Queue file) ①

D (to specify the Data file)

Jobname (jobnumber) (,queue) ②

EOJ (to enable cancellation of the program or selection of a new option).

① The complete data file will be dumped.

② This enables (a) queue record(s) belonging to a specific job in the RDR, LST, or PUN queue plus its associated track group(s) to be dumped. Job name may be 8 characters, job number may be 6 characters. For the 'queue' option one of the following three entries can be specified:

L, for LST queue (default)

P, for PUN-queue

R, for RDR queue.

After the dump is completed, the message

DUMP FUNCTION=

is issued to SYSLOG again to enable either a new option to be specified or the program to be terminated by the option EOJ.

Format of Output

For every 100 bytes, a block of four lines is printed. Line 1 contains the printable characters in those bytes; line 2 contains the zone-part of each byte; line 3 contains the numeric part of each byte; line 4 contains a scale indicating the position of the bytes in the string.

```
line 1: CHAR // JOB POWJOB01 DATE 08/19/74,
line 2: ZON 664DDC4DDEDCCFF44444444444 4444CCEC4FF6FF6FF6
line 3: NUMR 11016207661620100000000000 00004135008119174B
line 4: 01...5...10...15...20...25. .85...90...95.....
```

OS/VS1 Service Aids

Source: GC28-0665 OS/VS1 Service Aids

GTF (Generalized Trace Facility)

Traces selected system events such as SVC and I/O interruptions.

JOBQD

Operates as a stand-alone program to format and print the system job queue (SYS1.SYSJOBQE), the incore joblist, the system scheduler work area data set (SYS1.SYSWADS), and the scheduler work area data set (SWADS).

LIST

Formats and prints object modules, load modules, and CSECT identification records. Maps nucleus and link pack area.

OSJQD

Operates as a problem program to format and print the system job queue (SYS1.SYSJOBQE), the incore joblist, the system scheduler work area data set (SYS1.SYSWADS), and the scheduler work area data set (SWADS).

PRDMP

Formats and prints SADMP high-speed output (including page dump), SYS1.DUMP data set, and GTF trace data.

PTFLE

Application function: Applies PTF by generating input to the linkage editor, then invoking the linkage editor. Generate function: Generates JCL and control statements needed to apply PTFs or ICRs in a later step.

SADMP

Operates as a stand-alone program to produce a high-speed or low-speed dump of real storage. The high-speed version also dumps the page data set.

SPZAP

Verifies and/or replaces data in a load module.

OS/VS Service Aids

Source: OS/VS1 Service Aids, Rel. 3, GC28-0665-0
OS/VS2 Service Aids, Rel. 3.7, GC28-0674-1

Service Aids SADMP and PRDMP are essentially alike in OS/VS1 and OS/VS2 except that they are identified differently. In VS1 they are prefixed by the component identifier HMD (e.g., HMDSADMP); in VS2, by the identifier AMD (e.g., AMDSADMP). We shall use the short form here.

SADMP is a stand-alone program that produces:

- a low-speed dump of real storage on a tape or printer,
- or a high-speed dump of real or virtual storage on a tape.

The low-speed SADMP output directed to a tape may be printed with the PRDMP service aid program. The high-speed output on tape is formatted and may be printed with PRDMP. You cannot, however, write high-speed SADMP output directly to a printer.

Steps to Generate and Execute SADMP

HMDSADMP (VS1) and AMDSADMP (VS2) are supplied as macro definitions in SYS1.MACLIB. You perform a series of steps to get from the macro definition to the executable form of the SADMP program.

They are:

1. Mount tape containing SADMP macro.
2. Press Alter/Display Key.
3. Perform a Store Status.
4. Load address of SADMP tape drive into rotary switches.
5. Press LOAD button on console.
System: ENTER: HMD001A TAPE=
6. Mount a scratch tape.
7. Type address of scratch tape. Let's use address 281.
System: HMD014A INTV REQ 281
8. Press Load Rewind and Start buttons on tape drive. Ready light will come on.
System: HMD011A TITLE=
9. Type dump name. Let's type Smith4.
System: HMD005I REAL DUMP DONE

Note that:

- Stand-alone dump uses only real, online devices.
- When SADMP output is directed to a tape, a separate output tape is required for the dump.
- Do not IPL the stand-alone dump via a CPU from a channel controlled by the channel reconfiguration hardware (CRH).
- Procedure for generating SADMP on S/370 Model 158 differs.

OS/VS Service Aids

Generating and Executing SADMP on Model 158.

Substitute steps 2a, 2b, and 2c for step 2 above.

- 2a Press IMPL.
- 2b Select PRINTER-KBD option.
- 2c Select Alter/Display function.

Continue with step 3 above.

PRDMP is a service aid program that:

- provides the facilities to format and print data sets created by SADMP. The dump input may be high-speed or low-speed. For VS2, it must be OS/VS2 release 2 output.
- transfers a SYS1.DUMP data set produced by SVCDUMP to a permanent data set so that it can be retained. If the SYS1.DUMP data set is on a direct access device, PRDMP clears SYS1.DUMP so that SVCDUMP can reuse it.

You will need a JCL deck of cards for PRDMP consisting of the following:

```
//TRANS JOB MSGLEVEL=(1,1) Job card
//STEP1 EXEC PGM=HMDPRDMP or Execute statement
AMDPRDMP to execute program.
//SYSPRINT DD SYSOUT=A Input DD statement.
Defines where output
is--usually on tape.
//PRINTER DD SYSOUT=A Output DD statement.
Defines address to
which output is
to go--usually a
printer.
//TAPE DD DSN=SYS1.DUMP,DISP=OLD
//SYSUT1 DD DSN=DUMP2,UNIT=3330,VOL=SER=666666,
// DISP=(NEW,KEEP),SPACE=(4104,(257,1))
Defines workspace
to be used for
formatting dump.
//SYSIN DD *
TITLE SYS1.DUMP THURSDAY PM Insert control
LPAMAP cards that define
PRINT STORAGE what is wanted
END from dump behind
SYSIN card.
```

/*

OS/VS Service Aids

Steps for Generating a printout by PRDMP

1. Place JCL deck of cards for PRDMP in card reader and start reader.
2. System message at console will request that you mount tape.
3. Mount tape and ready tape drive.
4. Printer will start printing printout of dump.

How to Set Up an OLTEP Run

Source: GC28-0666 OS/VS1 OLTEP

1. Create OLTEP Data Sets: Run the OLTEP Editor Program to create a data set of online test programs and system configuration data. If you intend to test remote teleprocessing terminals, create a second data set containing configuration data for these symbolically named units. All configuration data, for both local devices and remote terminals, is supplied by IBM Field Engineering.
2. Modify OLTEP Data Sets: Use the OLTEP Punch program to obtain a punch-card copy of a member of the data set that needs to be modified. Then, using REP cards to make the desired changes, replace the member in the OLTEP data set by running the OLTEP Editor.
3. Catalog an OLTEP Procedure: Run the IEBUPDTE utility program to create and catalog an OLTEP procedure. Then, to run OLTEP, enter a START command at the console referring to the OLTEP procedure.
4. Define an OLTEP Job: If the START command will not be used to run OLTEP, code and punch JCL (job control statements) to define OLTEP as an OS/VS job. Then, to run OLTEP, enter the JCL in the OS/VS job stream. Optionally, include OLTEP control statements with your JCL to define some or all of the tests you want to run.

How to Set Up an OLTEP Run

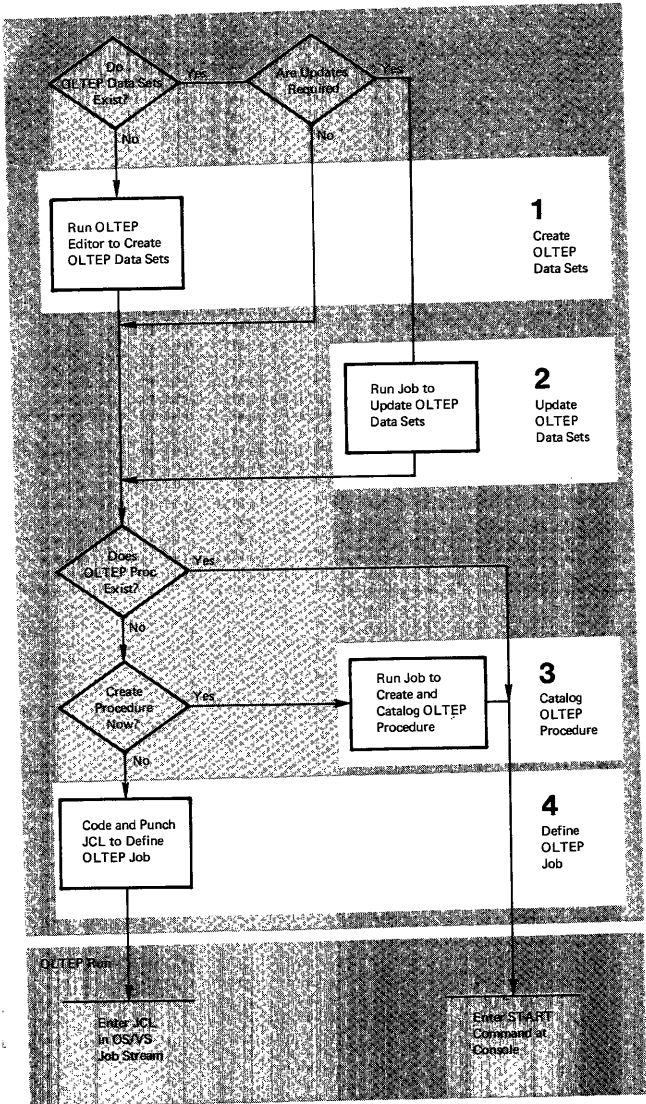

The OLTEP Run

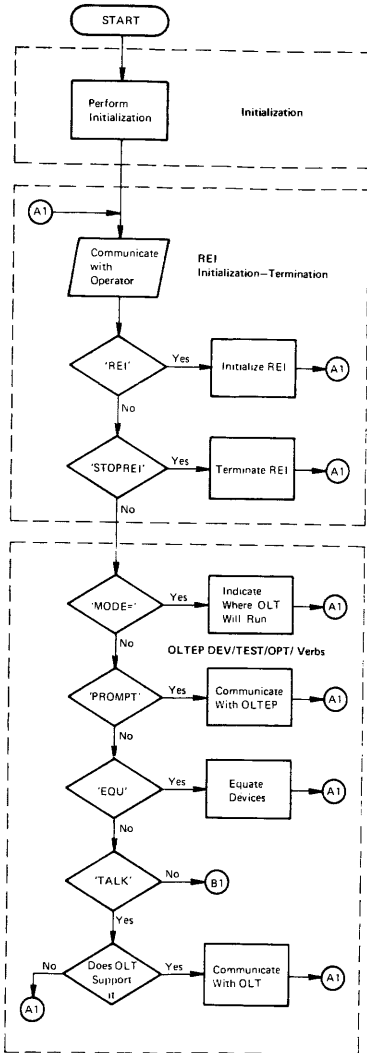

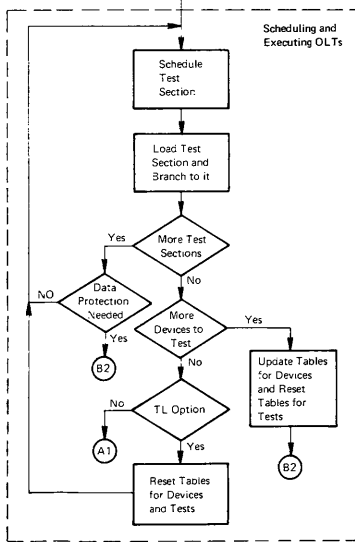
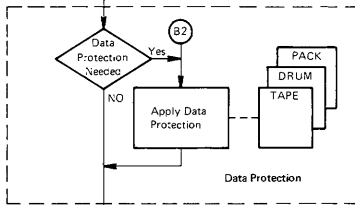
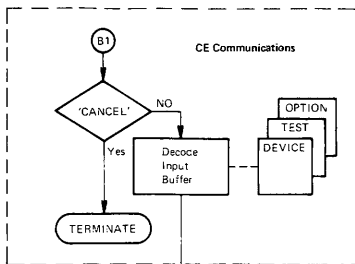

Section 7 Contents

Section 7: Glossary	7-1
---------------------------	-----

Glossary

Sources: *SR20-1078 System/360 Operator's Reference Guide*
GC33-5380 DOS/VS Service Aids and Procedures
GC20-1699 DP Glossary

NOTE: Asterisk before term indicates American National Standard Institute (ANSI) definition.

a

access method: A technique for moving data between main storage and an input/output device.

address constant: A number, or a symbol representing a number, used in calculating storage addresses.

address translation: The process of changing the address of an item of data or an instruction from its virtual address to its real storage address. See also dynamic address translation.

alias: Another name for a member of a partitioned data set; another entry point of a program.

allocate: Assign a resource to a job or task.

asynchronous: Without regular time relationship; unexpected or unpredictable with respect to the execution of a program's instructions.

attribute: A trait; for example, attributes of data include record length, record format, data set name, associated device type and volume identification, use, creation date, etc.

auxiliary storage: Data storage other than main storage. Synonymous with external storage, secondary storage.

b

basic access method: Any access method in which each input/output statement causes a machine input/output operation to occur. (The primary macro instructions used are READ and WRITE.)

basic control mode: When PSW bit 12 is 0, PSW format and system operation are compatible with standard System/360 operation. This is the basic control mode in which control registers 0, 8, and 14 are available to the system. Abbreviated to BC mode. See also "Extended Control Mode."

batch processing: (See stacked job processing.)

block (records): 1. To group records to conserve storage space or to increase the efficiency of access or processing. 2. A blocked record. 3. A portion of a telecommunications message defined as a unit of data transmission.

block loading: Bringing the control section of a load module into adjoining positions of main storage.

BTAM (basic telecommunications access method): A basic access method that permits a READ/WRITE communication with remote devices.

buffer (program input/output): A portion of main storage into which data is read, or from which it is written.

C

catalog: 1. The collection of all data set indexes maintained by data management. 2. To include the volume identification of a data set in the catalog. 3. In DOS to add a program to a library.

cataloged data set: A data set that is represented in an index or series of indexes.

cataloged procedure: A set of job control statements in the SYS1.PROCLIB data set. The procedure can be used by naming it in an execute (EXEC) statement.

CAW (channel address word): A word in main storage at location 72 that specifies the location in main storage where a channel program begins.

CCW (channel command word): A double word at the location in main storage specified by the CAW. One or more CCWs make up the channel program that directs channel operations.

CE pack: A disk pack used to test an IBM 2314, or 3330. It has an R0 data length of 6 at any location other than cylinder 0, track 0.

CE volume: If the device is a 2314 or 3330, see CE pack.

channel: A hardware device that connects the CPU and main storage with the I/O control units.

channel program: One or more Channel Command Words (CCWs) that control(s) a specific sequence of channel operations. Execution of the specific sequence is initiated by a single start I/O instruction.

channel program translation: In a channel program, replacement, by software, of virtual addresses with real addresses.

CIL: Core Image Library.

command control block (CCB): Under DOS and TOS, a 16-byte field required for each channel program executed by physical IOCS. This field is used for communication between physical IOCS and the problem program.

communication region: Under DOS and TOS, an area of the supervisor set aside for interprogram and intraprogram communication. It contains information useful to both the supervisor and the problem program. Abbreviated comreg. (Not to be confused with the COMRG macro instruction).

communications interval: A period of communication between the console operator and OLTEP. The operator is requested by OLTEP to enter the test-run definition at this time.

concatenated data set: A group of logically connected data sets.

Configuration Data Set (CDS): A record of information about an I/O device or CPU accessed by OLTEP and the CLT.

control blocks: A storage area used by the operating system to hold control information.

control dictionary: The external symbol dictionary and relocation dictionary, collectively, of an object or load module.

control program: The routines in the operating system that manage resources, implement data organization and communications conventions, or contain privileged operations.

control registers: In S/370, a set of registers used for operating system control of relocation, priority interruption, program event recording, error recovery, and masking operations.

control section: That part of a program specified by the programmer to be a relocatable unit, all of which is to be loaded into adjoining main storage locations.

control volume: A volume that contains one or more indexes of the catalog.

core-wrap mode: The method of operation that records the events of a trace in the PD area or an alternate area (used by PDAIDS). It is the default process when no output device for a PDAID trace has been specified.

CPU (central processing unit): The unit of a system that contains the circuits that control and perform the execution of instructions.

CRT (Cathode Ray Tube): Visual Display Screen.

CSW (channel status word): A word in main storage at location 64 that provides information about the termination of an input/output operation.

d

data management: Those parts of the control program that provide access to data sets, enforce data storage conventions, and regulate the use of input/output devices.

data organization: The arrangement of a data set.

data protection: A safeguard invoked to prevent the loss or destruction of customer data.

data security: A safeguard invoked to prevent the accessing of customer data.

data set: The major unit of data storage and retrieval in the operating system, consisting of a collection of data in one of several prescribed arrangements and described by control information that the system has access to.

data set control block (DSCB): A data set label for a data set in direct-access storage.

data set label (DSL): A collection of information that describes the attributes of a data set, and that is normally stored with the data set; a general term for data set control blocks and tape data set labels.

default value: A predetermined value used in place of an omitted entry.

deferred entry: An entry into a subroutine that occurs as a result of a deferred exit from the program that passed control to it.

deferred exit: The passing of control to a subroutine at a time determined by an asynchronous event rather than at a predictable time.

device independence: The ability to request input/output operations without regard to the characteristics of the input/output devices.

device name: Usually, the general name for a kind of device, specified at the time the system is generated. For example, 2314 or 3330 or TAPE. (See Unit name.)

direct access: Retrieval or storage of data by a reference to its location on a volume, rather than relative to the previously retrieved or stored data.

diskette: A flexible magnetic oxide coated disk, permanently enclosed in a semi-rigid protective plastic jacket approx. 8 inches square. During data processing operations the disk turns freely within the jacket. It is capable of storing 1898 128-character data records.

dispatching priority: A number assigned to tasks to determine the order in which they will use the central processing unit in a multitask situation.

DTF (define the file) macro instruction: A macro instruction that describes the characteristics of a logical input/output file, indicates the type of processing for the file, and specifies the I/O areas and routines to process the file.

dump: (1) To print out the contents of all or part of virtual storage or of auxiliary storage. (2) The data resulting from the process as in (1).

dynamic address translation (DAT): (1) In S/370, the change of a virtual storage address to an address in real storage during execution of an instruction. (2) A hardware feature that performs the translation.

e

emulator: The combination of programming techniques and special machine features that permits a given computing system to execute programs written for another system.

entry point: Any location in a program to which control can be passed by another program.

environmental recording, editing, and printing (EREP): A program that processes the data contained on the system recorder file.

error recovery procedures: Procedures designed to help isolate, and, when possible, to recover from hardware errors in equipment. The procedures are often used in conjunction with programs that record the statistics of machine malfunctions.

error volume analysis (EVA): With this DOS option, the system issues a message to the operator when a number of temporary read or write errors (specified by the user at system generation time) has been exceeded on a currently accessed tape file.

event: An occurrence of significance to a task; typically, the completion of an asynchronous operation, such as input/output.

exchange buffering: A technique using data chaining to avoid moving data in main storage, in which control of buffer segments and user program work areas is passed between data management and the user program.

exclusive segments: Segments in the same region of an overlay program, neither of which is in the path of the other. They cannot be in main storage simultaneously.

execute (EXEC) statement: A job control statement that designates a job step by identifying the load module to be fetched and executed.

expiration date: A date within a tape label for data protection. The tape cannot be used as a scratch tape without permission from the operator until this date has expired.

extent: The physical locations on input/output devices occupied by or reserved for a particular data set.

extended control mode: When PSW bit 12 is set to 1, the PSW format is changed from that used for standard System/360 operation: the channel mask bits, instruction length code, and interruption code are removed, and additional mode and mask bits are included. This is the extended control mode, in which all control registers are available to the system for control of facilities that are particular to System/370. Abbreviated to EC mode. See also "Basic Control Mode."

external reference: A reference to a symbol defined in another module.

external symbol: A control section name, entry point name, or external reference; a symbol contained in the external symbol dictionary.

external symbol dictionary (ESD): Control information associated with an object or load module which identifies the external symbols in the module.

f

F format: A data set record format in which logical records are the same length.

fetch (program): 1. To load requested load modules into main storage, relocating them as necessary. 2. A control routine that accomplished 1.

File Protect Mode (FPM): A mode of operation that insures maximum protection and security of customer data. While in file protect mode, the system performs no write operations and reads no customer data.

fixed page: A page in real storage that is not to be paged out.

F/L Trace (Fetch/Load Trace): Under DOS and TOS, a program that records information about phases and transients as they are called from a core image library.

g

generation data group: A collection of successive, historically related data sets.

GPR (General-purpose register): Temporary storage with capacity of one word. There are 16 GPRs on System/370 computers.

GSVC Trace (Generalized Supervisor Calls Trace): A program that records SVC interrupts as they occur. All or a selected group of SVCs can be traced.

h

hard copy: A printed copy of machine output in a visually readable form, for example, a printed recording of the messages displayed on the System/370 Model 125 video display unit.

hard stop: A condition, usually caused by an error, in which the CPU is stopped and is not executing the microprogram.

i

IC (instruction counter): Hardware circuit which tells the central processor (CPU) the main storage address at which it will find the next instruction to execute.

inclusive segments: Overlay segments in the same region that can be in main storage simultaneously.

index (data management): 1. A table in the catalog structure used to locate data sets. 2. A table used to locate the records of an indexed sequential data set.

initial program loading (IPL): The initialization procedure which loads the nucleus and begins normal operations.

initiator: The part of the job scheduler that selects jobs and job steps to be executed, allocates input/output devices for them, places them under task control, and at completion of the job, supplies control information for writing job output on a system output unit.

input queue: A queue of job definitions in direct access storage, assigned to a job class and arranged in assigned priority order, waiting to be processed.

input stream: Job control statements entering the system; may also include input data.

installation: A particular computing system, in terms of the overall work it does and the people who manage it, operate it, apply it to problems, service it, and use the results it produces.

interrupt: A break in the normal sequence of instruction execution. It causes an automatic transfer to a preset storage location where appropriate action is taken.

invalid page: In S/370, a page that cannot be directly addressed by the dynamic address translation feature of the central processing unit.

I/O area: An area (portion) of real storage into which data is read or from which data is written; the term buffer is often used in place of I/O area.

I/O Trace (Input/Output Trace): A program that records I/O device activity for all or a selected group of I/O devices.

IOCS (input/output control system): A group of macro instruction routines provided by IBM for handling the transfer of data between main storage and external storage devices.

irrecoverable error: A hardware error which cannot be recovered from by the normal hardware and retry procedures.

j

job: 1. A unit of work for the system from the standpoint of installation accounting and control. A job consists of one or more job steps. 2. A collection of related problem programs, identified in the input stream by a JOB statement followed by one or more EXEC statements.

job control statement: A control statement in the input stream that identifies a job or defines its needs.

job library: A set of user-identified partitioned data sets used as the main source of load modules for a given job.

job management: A general term for the functions of job scheduling and command processing.

job queue: (See input queue.)

job (JOB) statement: The control statement in the input stream that identifies the beginning of a series of job control statements for a single job.

job step: A unit of work associated with one processing program or one cataloged procedure, and related data.

language translator: Any assembler, compiler, or other routine that accepts statements in one language and produces equivalent statements in another language.

library: 1. A collection of objects (for example, data sets, volumes, card decks) associated with a particular use, and identified in a directory. See job library, link library, system library. 2. Any partitioned data set.

limit priority: In OS/VS2 and MVT, a number associated with a task in a multitask operation, representing the highest dispatching priority that the task can assign to itself or to any of its subtasks.

link library: A partitioned data set which, unless otherwise specified, is used in fetching load modules referred to in execute (EXEC) statements and in ATTACH, LINK, LOAD, and XCTL macro instructions.

linkage: The coding that connects two separately coded routines.

linkage editor: A program that produces a load module by changing object modules into a form acceptable to fetch, combining object modules and load modules into a single new load module, resolving symbolic cross references among them, replacing, deleting, and adding control sections automatically on request, and providing overlay facilities for modules requesting them.

load: In programming, to enter instructions or data into storage or working registers. In DOS/VS, to bring a program phase from a core image library into virtual storage for execution.

load module: The output of the linkage editor; a program in a form suitable for loading into main storage for execution.

locate mode: A way of providing data by pointing to its location instead of moving it.

logic module: The logical IOCS routine that provides an interface between a processing program and physical IOCS.

logical record: A record that is defined in terms of the information it contains rather than by its physical traits.

* **loop:** A sequence of instructions that is executed repeatedly until a terminal condition prevails.

LSERV (label cylinder display): A program that formats a listing of the label cylinder located on SYSRES.

m

machine check analysis and recovery: 1. A feature that checks the severity of a CPU hardware failure and attempts to recover from the interrupt. Abbreviated MCAR. 2. In S/370 Mod 168 MCAR designates Maintenance Control Address Register.

machine check interrupt: The interrupt that occurs if the CPU fails to operate.

macro instruction: The macro instruction statement, the corresponding macro instruction definition, the resulting assembler language statements, and the machine language instructions and other data produced from the assembler language statements; loosely, any one of these representations of a machine language instruction sequence.

main page pool: In DOS/VS, the set of all page frames in real storage not assigned to the supervisor or one of the real partitions.

main storage: 1. The real address area of virtual storage. Contrast with auxiliary storage. 2. All program addressable storage from which instructions may be executed and from which data can be loaded directly into registers.

master scheduler: The part of the control program that responds to operator commands and returns required information.

MCAR Maintenance Control Address Register
(Mod 165 and 168)

MCDR Maintenance Control Data Register
(Mod 165 and 168)

MCER Maintenance Control Entry Register
(Mod 165 and 168)

microprogram: A set of basic or elementary machine instructions that is loaded into control storage to control CPU operations.

module (programming): A program unit that is input to, or output from, a single execution of an assembler, compiler, or linkage editor; a source, object, or load module.

move mode: A way of providing data by moving it instead of pointing to its location.

MRAR Maintenance Ripple Address Register
(Mod 165 and 168)

multijob operation: Concurrent execution of job steps from two or more jobs.

multiplexer channel: A channel designed to operate with a number of I/O devices simultaneously on a byte basis. That is, several I/O devices can be transferring records over the multiplexer channel, time-sharing it on a byte basis.

multiplexer mode: A means of transferring records to or from low-speed I/O devices on the multiplexer channel, by interleaving bytes of data. The multiplexer channel sustains simultaneous I/O operations on several subchannels. Bytes of data are interleaved and then routed to or from the selected I/O devices or to and from the desired locations in main storage. Multiplex mode is sometimes referred to as byte mode.

multiprogramming system: A system that controls more than one program simultaneously by interleaving their execution.

multitasking: The concurrent execution of one main task and one or more subtasks in the same position.

n

name: A set of one to eight characters that identifies a statement, data set, module, etc., and that is usually associated with the location of that which it identifies.

nucleus: That part of the control program that must always be present in main storage. Also, the main storage area used by the nucleus and other transient control program routines.

O

object module: The output of a single execution of an assembler or compiler, which constitutes input to linkage editor. An object module consists of one or more control sections in relocatable, though not executable, form and an associated control dictionary.

offline: 1. *Pertaining to equipment or devices not under control of the central processing unit. 2. Pertaining to program error diagnosis without using the computer system (offline program debugging).

* **online:** 1. Pertaining to equipment or devices under control of the central processing unit. 2. Pertaining to a user's ability to interact with a computer.

online test executive program (OLTEP): The control program of the online test system. OLTEP is the interface between the online test and the operating system.

on-line test system: A control program, OLTEP, and a series of tests (OLTs) designed to test I/O devices while permitting normal system processing in the foreground partitions.

operand: 1. * That which is operated upon. An operand is usually identified by an address part of an instruction. 2. Information entered with a command name to define the data on which the command processor operates and to control the execution of the command processor.

operator command: A statement to the control program, issued via a console device, which causes the control program to provide requested information, alter normal operations, initiate new operations, or terminate existing operations.

output queue: A queue of control information describing system output data sets, that specifies to an output writer the location and disposition of system output.

output writer: A part of the job scheduler that writes output data sets onto a system output unit, independently of the program that produced such data sets.

* **overflow:** 1. That portion of the result of an operation that exceeds the capacity of the intended unit of storage. 2. Pertaining to the generation of overflow as in (1).

p

page: 1. A fixed-length block of instructions, data or both, that can be transferred between real storage and external page storage. 2. To transfer instructions, data, or both, between real storage and external page storage.

page data set: An extent in auxiliary storage, in which pages are stored.

page fault: A program interruption that occurs when a page that is marked "not in real storage" is referred to by an active page. Synonymous with page translation exception.

page frame: A 2K block of real storage that can contain a page.

page frame table: A table that contains an entry for each frame. Each frame entry describes how the frame is being used.

page pool: The set of all page frames that may contain pages of programs in virtual mode.

page table (PGT): A table that indicates whether a page is in real storage and correlates virtual addresses with real storage addresses.

page translation exception: A program interruption that occurs when a virtual address cannot be translated by the hardware because the invalid bit in the page table entry for that address is set. See also segment translation exception, translation specification exception.

paging The process of transferring pages between real storage and the page data set.

parallel processing: Concurrent execution of one or more programs.

* **parameter:** A variable that is given a constant value for a specific purpose or process.

partition: 1. In OS/VS1, a division of the dynamic area of virtual storage, established at system generation. 2. In DOS/VS, a division of the virtual address area of virtual storage that is allocated for programs that may be paged.

Partitioned data set: A data set divided into several members. Each member has a unique name and is listed in a directory at the beginning of the data set. Members can be added or deleted as needed. Records within members are organized sequentially.

path: A series of segments that form the shortest distance in a region between a given segment and the root segment.

physical IOCS: Macro instructions and supervisor routines (Channel Scheduler) that schedule and supervise the execution of channel programs. Physical IOCS controls the actual transfer of records between the external storage medium and real storage.

physical record: A record that is defined in terms of physical qualities rather than by the information it contains.

polling: A technique by which each of the terminals sharing a communications line is periodically checked to determine if it requires servicing.

post: Note the occurrence of an event.

private library (of a job step): A partitioned data set other than the link library or the job library.

Private Second Level Directory (PSLD): The Private Second Level Directory is a table, located in the Supervisor and containing the highest phasenames found on the corresponding directory tracks of the Private Core Image Library.

privileged instruction: An instruction that can be executed only while the CPU is in the supervisor state. Protection I/O, direct control, and any instructions that manipulate the program status words are privileged.

problem determination aids (PDAID): Programs that trace a specified event when it occurs during the operation of a program. The traces provided are: QTAM Trace, I/O Trace, F/L Trace, and GSVC Trace.

problem program: Any program that is executed when the central processing unit is in the problem state; that is, any program that does not contain privileged instructions. This includes IBM-distributed programs, such as language translators and service programs, as well as programs written by a user.

processing program: 1. A general term for any program that is not a control program. 2. Synonymous with problem program.

processor: 1. * In hardware, a data processor. 2. * In software, a computer program that includes the compiling, assembling, translating, and related functions for a specific programming language. RPG II processor, FORTRAN processor. 3. Same as processing program.

program event recording: A System/370 feature that enables a program to be alerted to specific events. Abbreviated PER.

PSW (program status word): A double word in main storage used to control the order in which instructions are executed, and to hold and indicate the status of the system in relation to a particular program.

PTF: Program Temporary Fix

q

qualified name: A data set name that is composed of multiple names separated by periods (for example, TREE.FRUIT.APPLE).

qualifier: All names in a qualified name other than the rightmost, which is called the simple name.

queue: 1. A waiting line or list formed by items in a system waiting for service; for example, tasks to be performed or messages to be transmitted in message switching system. 2. To arrange in, or form, a queue.

queued access method: An access method that automatically governs the movement of data between the program using the access method and input/output devices. (The primary macro instructions used are GET and PUT.)

Quiesce Mode: A mode of operation that requires the foreground partition to be stopped by the operator. The operator does this on the console by issuing the PAUSE EOJ and STOP commands when requested by OLTEP.

QTAM Trace: A program that records certain supervisor and I/O activities on tape or in core-wrap mode.

R

reader: 1. A device that converts information in one form of storage to information in another form of storage. 2. A part of the scheduler that reads an input stream into the system.

ready condition: The condition of a task that is ready to be performed by the central processing unit.

real address: In VS, the address of a location in real storage.

real address area: The area of virtual storage where virtual addresses are equal to real addresses.

real mode: In DOS/VS, the mode of a program that may not be paged.

real storage: The storage of a System/370 computing system from which the central processing unit can directly obtain instructions and data, and to which it can directly return results. Synonymous with processor storage.

real partition: In DOS/VS, a division of the real address area of virtual storage that may be allocated for programs that are not to be paged, or programs that contain pages that are to be fixed.

record: A unit of data.

recovery management support: The facilities that gather information about hardware reliability and allow retry of operations that fail because of CPU, I/O device, or channel errors. Abbreviated to RMS.

reenterable: The attribute of a set of code that allows the same copy of the set of code to be used concurrently by two or more tasks.

reliability data extractor (RDE): A function that provides hardware reliability data that is analyzed by IBM.

relocatable library: A library of relocatable object modules and IOCS modules required by various compilers. It allows the user to keep frequently used modules available for combination with other modules without recompilation.

resource: Any facility of the computing system or operating system required by a job or task, and including main storage, input/output devices, the central processing unit, data files, and control and processing programs.

resource manager: Any control program routine responsible for the handling of a resource.

* **routine:** An ordered set of instructions that may have some general or frequent use.

S

scheduler: (See master scheduler and job scheduler.)

Second Level Directory (SLD): The table, located in the Supervisor and containing the highest phase-names found on the corresponding directory tracks of the system core image.

secondary storage: Auxiliary storage.

seek: Position the access mechanism of a direct-access device at a specified location.

segment: A continuous 64K area of virtual storage, which is allocated to a job or system task.

segment table (SGT): A table used in dynamic address translation to control user access to virtual storage segments. Each entry indicates the length, location, and availability of a corresponding page table.

segment translation exception: A program interruption that occurs when a virtual address cannot be translated by the hardware because the invalid bit in the segment table entry for that address is set. See also page translation exception, translation specification exception.

self-relocating: A programmed routine that is loaded at any doubleword boundary and can adjust its address values so as to be executed at that location.

self-relocating program: A program that is able to run in any area of storage by having an initialization routine to modify all address constants at object time.

selector channel: A channel designed to operate with only one I/O device at a time. Once the I/O device is selected, a complete record is transferred one byte at a time.

SEREP: A stand-alone environment recording, editing, and printing program that makes the data contained in an error log out area of real storage available for further analysis.

Shared Virtual Area (SVA): The last part of the virtual system address space that contains phases which are reenterable and relocatable and which can be shared between partitions.

simple name: The rightmost component of a qualified name (for example APPLE is the simple name in TREE.FRUIT.APPLE).

soft stop: A condition in which the CPU has stopped processing but continues to handle any requested interruptions.

source module: A series of statements which make up the entire input to a single execution of an assembler or compiler.

stacked job processing: A technique that permits multiple job definitions to be grouped (stacked) for presentation to the system, which automatically recognizes the jobs, one after the other.

stand-alone dump: A program that displays the contents of the registers and all of real storage and that runs independently.

storage block: An area of main storage consisting of 2048 bytes to which a storage key can be assigned.

* **storage protection:** An arrangement for preventing access to storage for either reading, or writing, or both.

subtask: A task in which control is initiated by a main task by means of a macro instruction that attaches it.

supervisor: The part of a control program that coordinates the use of resources and maintains the flow of CPU operations.

supervisor state: The state of CPU operation that allows execution of privileged instructions. When bit 15 of the PSW is zero, the CPU is in the supervisor state.

SVA: See Shared Virtual Area.

SVC (supervisor call): An instruction which causes an SVC interruption in the hardware to give control to a control program routine (called an SVC routine) for some specific action, such as reassigning parts of main storage or retrieving data from an I/O device.

synchronous: Occurring with a regular or predictable time relationship.

SYSIN: A system input stream.

SYSOUT: A system output stream.

system generation (SYSGEN): The process of tailoring the IBM-supplied operating system to user requirements. †

system debugging aids: A set of routines provided to trace specific program events by using the program event recording facilities. Abbreviated SDAIDS.

System Directory List (SDL): A list of highly used phases (either only in the system CIL or also in the SVA). This list is placed in the SVA.

system input unit: A device specified as a source of an input stream.

system library: The collection of all cataloged data sets at an installation.

system macro instruction: A macro instruction that provides access to operating system facilities.

system output unit: An output device shared by all jobs.

system recorder file: The data file that is used to record hardware reliability data.

system residence volume: The volume on which the nucleus of the operating system and the highest level index of the catalog are located.

SYSCTLG: An optional system data set on the primary system residence device containing addresses relating installation data set names to specific volume numbers.

SYS1.LINKLIB: A system data set containing the system program modules that are not either permanently resident in main storage or resident in the SYS1.SVCLIB.

SYS1.LOGREC: A system data set on the primary system residence device containing information regarding system failures.

SYS1.NUCLEUS: A system data set on the primary system residence device containing the IPL program and the primary nucleus.

SYS1.PROCLIB: A data set containing cataloged procedures—handy sets of control statements that can be called into use by EXEC statements.

SYS1.SVCLIB: A system data set on the primary system residence device containing all of those SVC routines, I/O error recovery routines, and access method routines, that are not permanently resident in main storage.

SYS1.SYSJOBQE: A system data set used by the scheduler as a storage and work area for information about the input and output streams. Contains the input and output queues.

t

task: A unit of work for the central processing unit from the standpoint of the control program.

task queue: A queue of all the task control blocks present in the system at any one time.

task selection: The supervisor mechanism for determining which program should gain control of CPU processing.

telecommunications: Data transmission between a system and remotely located devices via a unit that performs format conversion and controls the rate of transmission.

teleprocessing: The processing of data that is received from or sent to remote locations by way of telecommunication lines.

terminal: 1. * A point in a system or communication network at which data can either enter or leave. 2. Any device capable of sending and receiving information over a communication channel.

Terminating partition: In DOS/VS this is a partition owning a program which is in the process of being terminated either because of a program cancel condition or because of EOJ.

test—run definition: Information requested by OLTEP at the various communications intervals. This information consists of the device to be tested, the test or test routines to be executed, and the options to be exercised.

test translator: A facility that allows various debugging procedures to be specified in assembler language programs.

text: The control sections of an object or load module.

throughput: The rate at which work can be handled by a system.

trace: 1. To record a series of events as they occur. 2. The record of a series of events.

* **tracing routine:** A routine that provides a historical record of specified events in the execution of a program.

track hold: A function for protecting DASD tracks that are currently being processed. When track hold is specified in the DTF, a track that is being modified by a task in one partition cannot be concurrently accessed by a task or subtask in another partition.

Transient area: An area in the supervisor used for temporary storage of transient routines, such as non-resident supervisor call or error-handling routines.

transient routines: These self-relocating routines are permanently stored on the system residence device and loaded (by the supervisor) into the transient area when needed for execution.

translation specification exception: A program interruption that occurs when a page table entry, segment table entry, or the control register pointing to the segment table contains information in an invalid format. See also page translation exception, segment translation exception.

transmittal mode: The way the contents of an input buffer are made available to the program, and the way a program makes records available for output.

turnaround time: The time between submission of a job to a computing center and the return of results.

U

U format: A data set format in which blocks are of unknown length.

unit name: Usually, the unit address of a particular device, specified at the time a system is installed. For example 191 or 293. (See device name.)

user program: See problem program.

unrecoverable error: See irrecoverable error.

utility program: A program designed to perform a routine task, such as transcribing data from one storage device to another.

V

V format: A data set format in which logical records are of varying length and include a length indicator; and in which V format logical records may be blocked, with each block containing a block length indicator.

virtual address: An address that refers to virtual storage and must, therefore, be translated into a real storage address when it is used.

virtual address area: In DOS/VS and OS/VS, the area of virtual storage whose addresses are greater than the highest address of the real address area.

virtual mode: In DOS/VS and OS/VS, the mode of a program which may be paged.

virtual storage: Addressable space that appears to the user as real storage, from which instructions and data are mapped into real storage locations. The size of virtual storage is limited by the addressing scheme of the computing system and by the amount of auxiliary storage available, rather than by the actual number of real storage locations.

virtual storage access method (VSAM): VSAM is an access method for direct or sequential processing of fixed and variable length records on direct access devices. The records in a VSAM file can be organized either in logical sequence by a key field (key sequence) or in the physical sequence in which they are written on the file (entry-sequence). A key-sequenced file has an index, an entry-sequenced file does not.

volume: 1. That portion of a single unit of storage media which is accessible to a single read/write mechanism, for example, a drum, a disk pack, or part of a disk storage module. 2. A recording medium that is mounted and dismounted as a unit, for example, a reel of magnetic tape, a disk pack, a data cell.

volume table of contents (VTOC): A table associated with a direct-access volume, which describes each data set on the volume.

VSAM access method services: A multifunction utility program that defines VSAM files and allocates space for them, converts indexed sequential files to key-sequenced files with indexes, facilitates data portability between operating systems, creates backup copies of files and indexes, helps make inaccessible files accessible, and lists file and catalog entries.

W

wait condition: The condition of a task that needs one or more events to occur before the task can be ready to be performed by the central processing unit.

wait state: The state of the system when no instructions are being processed, but the system is not fully stopped. The system can accept I/O and external interruptions, and can be put through the IPL procedure.

wraparound: 1. The continuation of an operation from the maximum addressable location in storage to the first addressable location. 2. The continuation of register addresses from the highest register address to the lowest. 3. On a CRT display device, the continuation of an operation, e.g., a read or cursor movement, from the last character position in the display buffer to the first position in the display buffer.

Section 8 Contents

Section 8: Bibliography	8-1
-------------------------------	-----

BIBLIOGRAPHY: List 1

Publications referenced in this Guide, arranged in numerical order.

This list only contains publications cited in this guide.

GA21-9124	IBM 3505 Card Reader and 3525 Card Punch Subsystem Component Description
GA21-9167	5425 MFCU Prog. Ref. Manual and Operating Guide
GA22-6846	IBM S/360 2702 Transmission Control
GA22-6895	S/360 2301 2820 Component Description
GA22-6954	IBM S/360 and S/370 Mod 195 Operating Procedures
GA22-6966	IBM S/370 Mod 155 Operating Procedures
GA22-6969	IBM S/370 Mod 165 Operating Procedures
GA22-7000	IBM S/370 Principles of Operation
GA22-7017	IBM S/370 155 II DAT
GA24-3543	IBM 3211 Printer, 3216 Interchangeable Train Cartridge, and 3811 Printer Control Unit Component Description and Operator's Guide
GA26-1589	S/360 2835 2305 System Ref. Manual
GA26-1617	Reference Manual for 3830 Storage Control Model 2
(GN26-0311)	
GA26-1619	IBM 3340 Reference Manual
GA26-5988	2841 2302/03/11/21 Component Description
GA27-2742	Operator's Guide for IBM 3270 Information Display Systems
GA27-3051	Introduction to 3705 Communications Controller, Principles of Operation
GA32-0020	IBM 3803 3420 Magnetic Tape Subsystems Component Description
GA32-0021	IBM 3803 3420 Magnetic Tape Subsystems, Subsystem Description
GA32-0022	IBM 3410/3411 Magnetic Tape Subsystems Component Description
GA33-1506	S/370 Mod 125 Functional Characteristics
GA33-1509	IBM S/370 Mod 125 Procedures
GA33-1510	IBM S/370 Mod 115 Functional Characteristics
GA33-3010	IBM S/370 Mod 135 Channel Characteristics
GC20-1699	Data Processing Glossary
GC20-1804-3	IBM VM Facility/370: Command Language Guide for General Users
GC20-1806-4	IBM Virtual Machine Facility/370 Operator's Guide, Release 2
GC24-5091-4	OS/VS1 Programmer's Reference Digest VS1 Release 5
GC26-3784	OS/VS Checkpoint/Restart
GC27-6993	HASP II Version 4 Operator's Guide
GC27-6997	VTAM Operating Procedures
GC28-0638	OS/VS SYS1.LOGREC Error Recording, VS1 and VS2
GC28-0665-0	OS/VS1 Service Aids
GC28-0666	OS/VS1 OLTEP
GC30-2046	OS/VS TCAM Operator's Library
GC33-5378-2	DOS/VS Operating Procedures, Release 31
(GN33-9180)	Release 32
GC33-5380	DOS/VS Serviceability Aids and Debugging Procedures, Release 32
GC33-5381	DOS/VS System Utilities, Release 32
GC35-0005	OS/VS Utilities
GC38-0005	IBM S/370 Mod 135 Procedures
GC38-0014	IBM 3850 Mass Storage System (MSS)
GC38-0015	IBM S/370 Mod 145 Operating Procedures
GC38-0025	IBM S/370 Mod 158 Operating Procedures
GC38-0030	IBM S/370 Mod 168 Operating Procedures
GC38-0110-5	Operator's Library: OS/VS1 Reference VS1 Release 5
GC38-0210-3	Operator's Library: OS/VS2 Reference VS2 Release 3
GC38-0225	OS/VS2 Oper. Remote Term.
GC38-0226	Operator's Library: OS/VS2 (JES3) Reference
GC38-0255-3	OS/VS1 Display Consoles
GC38-0260-1	OS/VS2 Display Consoles
GC38-1001-4	VS1 System Messages
GC38-1002-3	VS2 System Messages
SR20-1078-4	IBM S/360 Operator's Reference Guide
SR20-7091	OS/VS1 Basic Operations-Illustrations
GX20-1850	S/370 Reference Summary
GX20-1926	IBM Virtual Machine Facility/370 Quick Guide for Users
GX28-0647	OS/VS2 TSO Command Language Summary
GX38-0227	OS/VS2 (JES2) Command Language Reference Summary
GY32-5034	Tape Unit Cleaning Procedure (3420 tape)
SY33-8571	DOS/VS Handbook, Release 31, Vol. I
SY33-8572	DOS/VS Handbook, Rel. 31, Vol. II
G232-0004	IBM 3410/3411 Operator's Guide
S232-0003-2	IBM 3420 Operator's Guide

BIBLIOGRAPHY: List 2

This list is arranged by subject matter and includes some publications not quoted from nor referenced in this guide that are added because they are pertinent and useful for background.

General Information

- GA22-6822 IBM S/360 and S/370 Bibliography
- GC20-1699 Data Processing Glossary

General System Information

- GA22-7001 IBM S/370 System Summary
- GA22-7000 IBM S/370 Principles of Operation
- GX20-1850-2 S/370 Reference Summary Card
- SR20-1078-4 IBM S/360 Operator's Reference Guide

Machine System

- GA33-1510 IBM S/370 Mod 115 Functional Characteristics
- GA33-1509 IBM S/370 Mod 125 Procedures
- GA33-1506 IBM S/370 Mod 125 Functional Characteristics
- GC38-0005 IBM S/370 MOD135 Procedures
- GA33-3005 IBM S/370 Mod 135 Functional Characteristics
- GA33-3010 IBM S/370 Mod 135 Channel Characteristics
- GC38-0015 IBM S/370 Mod 145 Operating Procedures
- GA24-3557 IBM S/370 Mod 145 Functional Characteristics
- GA24-3573 IBM S/370 Mod 145 Channel Characteristics
- GA22-6966 IBM S/370 Mod 155 Operating Procedures
- GA22-6942 IBM S/370 Mod 155 Functional Characteristics
- GA22-6962 IBM S/370 Mod 155 Channel Characteristics
- GA22-7017 IBM S/370 Mod 155 II DAT Facility
- GC38-0025 IBM S/370 Mod 158 Operating Procedures
- GA22-7011 IBM S/370 Mod 158 Functional Characteristics
- GA22-7012 IBM S/370 Mod 158 Channel Characteristics
- GA22-6969 IBM S/370 Mod 165 Operating Procedures
- GA22-6935 IBM S/370 Mod 165 Functional Characteristics
- GA38-0030 IBM S/370 Mod 165 Operating Procedures
- GX22-6984 IBM S/370 Mod 165 Operator's Reference Card
- GA22-7010 IBM S/370 Mod 168 Functional Characteristics
- GA22-6954 IBM S/360 and S/370 Mod 195 Operating Procedures
- GA22-6943 IBM S/360 and S/370 Mod 195 Functional Characteristics

DASD

- GA22-6895 IBM S/360 Component Description 2820 Storage Control and 2301 Drum Storage
- GA26-5988 IBM S/360 Component Description, 2841 and associated DASD, 2311 Disk Storage Drive, 2321 Data Cell Drive, 2303 Drum Storage
- GA26-1589 Component Summary, 2835 Storage Control, 2305 Fixed Head Storage
- GA26-3599 IBM S/360 Component Descriptions, 2314 Direct Access Storage Facility and 2844 Auxiliary Storage Control
- GA26-1606 IBM 2319 Disk Storage Component Description
- GA26-1592 Reference Manual for IBM 3830 Storage Control and IBM 3330 Disk Storage
- GA26-1619 IBM 3340 Component Summary

Diskette

- GA26-4187 Diskette Handling Procedures

Magnetic Tape Units

- G232-0004 IBM 3410/3411 Operator's Guide.
- GA32-0022 IBM 3410/3411 Magnetic Tape Subsystems Component Description
- S232-0003 IBM 3420 Operator's Guide
- GA32-0020 IBM 3803/3420 Magnetic Tape Subsystems Component Description
- GA32-0021 IBM 3803/3420 Magnetic Tape Subsystems, Subsystem Description
- GY32-5034 Tape Unit Cleaning Procedure (3420)
- SY32-5033 Tape Unit Cleaning Procedures (2420, 3420)
- GA22-6866 IBM S/360 Component Descriptions: 2400 Series, 2803/2804 Tape Controls, and 2816 Switching Unit

Printers

- GA24-3552 IBM 3210 Console Printer Keyboards
- GA24-3543 IBM 3211 Printer, 3216 Interchangeable Train Cartridge, and 3811 Printer Control Unit Component Description and Operator's Guide
- GA24-3073 IBM 1403 Printer Component Description

Card Readers and/or Punches

GA26-5893 IBM 2560 Multifunction Card Machine Component Description
GA21-9124-3 IBM 3504 Card Reader, IBM 3505 Card Reader and
(GN21-0166) IBM 3525 Card Punch Subsystem Component Description
GA21-9167 IBM S/370 5425 Multifunction Card Unit Programmer's Reference
Manual and Operator's Guide

Display Equipment

GA27-2739 An Introduction to the IBM 3270 Information Display System
GA27-2742-2 IBM 3270 Information Display Systems Operator's Guide
SY27-2330 IBM 3277 Display Station Troubleshooting Guide
GA27-2701 IBM S/360 2250 Display Unit Component Description
GA27-2700 IBM S/370 2260 Display Station Component Description

Keyboard and Terminal Devices

SH20-1232 IBM 2740 Communication Terminal
GC28-2017 IBM 2741 Communication Terminal
GA27-3070 IBM 3735 Programmable Buffered Terminal

Transmission Control Devices

GA22-6864 IBM 2701 Data Adapter Unit Operation
GA22-6846 IBM S/360 2702 Transmission Control
GA27-3051 Introduction to 3705 Communications Controller Principles of Operation

Data Entry Systems

GA21-9152-1 IBM 3740 Data Entry System
GA21-9131 IBM 3741 Data Station Operator's Guide

* * * *

Operating Systems

GR20-4260 Introduction to Virtual Storage in S/370
GC38-0335 Operator's Library OS/VS1 CRJE
GC38-0120 Operator's Library: OS/VS Console Configurations
GC38-0255 OS/VS1 Display Consoles
GC28-0665 OS/VS1 Service Aids
GC38-0110 Operator's Library OS/VS1 Reference
GC30-2037 Operator's Library: OS/VS TCAM
GC38-1007 OS/VS Message Library: Linkage Editor and Loader Messages
GC38-1004 OS/VS Message Library: Routing and Descriptor Codes
GC38-1006 OS/VS Message Library: Service Aids and OLTEP Messages
GC38-1003 OS/VS Message Library: VS System Codes
GC38-1001 OS/VS Message Library: VS1 System Messages
GC38-1005 OS/VS Message Library: Utilities Messages
GC38-1010 OS/VS Message Library: VS1 RES RTAM and Account Messages
GC26-3791 OS/VS1 System Generation Reference
GC24-5093 OS/VS1 Debugging Guide
GC28-0666 OS/VS1 OLTEP
GC26-3784 OS/VS Checkpoint/Restart, VS1 and VS2
GC28-0668 OS/VS1 SYS1.LOGREC Error Recording
GC24-5091 OS/VS1 Programmer's Reference Digest
GC35-0005 OS/VS Utilities, VS1 and VS2
* GC38-0210 Operator's Library: OS/VS2 Reference
* GC38-0260 OS/VS2 Display Consoles
* GC38-1002 VS2 System Messages
* GC28-0638 OS/VS SYS1.LOGREC Error Recording
GC35-0005 OS/VS2 Utilities
GX38-0227 OS/VS2 (JES2) Command Language Reference Summary
GC38-0226 Operator's Library: OS/VS2 (JES3) Reference
GC38-0210 Operator's Library: OS/VS2 Reference

DOS

GC33-5370	Introduction to DOS/VS
GC33-5378	DOS/VS Operating Procedures
GC33-5380	DOS/VS Serviceability Aids and Debugging Procedures
GC33-5381	DOS/VS System Utilities
GC33-5383	DOS/VS OLTEP Reference
SY33-8571	DOS/VS Handbook, Vol. I
SY33-8572	DOS/VS Handbook, Vol. II

VM

GC20-1806	IBM Virtual Machine Facility/370 Operator's Guide
GX20-1926	IBM Virtual Machine Facility/370 Quick Guide for Users

WHEN COMPLETING AR REPORTS RELATED TO PROGRAMS AND PROGRAMMING SYSTEMS, THE CORRESPONDING FE SERVICE NUMBER MUST BE NOTED. WHEN WRITING AN INCOMPLETE AR (2 IN 'CIA' BLOCK) RELATING TO PROGRAMMING SYSTEMS, THE SYSTEM BASE NUMBER MAY BE USED. SYSTEM BASE FE SERVICE NUMBERS ARE AS FOLLOWS:

360D	- 009	360N	- 002	360P	- 004
360S	- 001	370N	- 042	OS/VSI	- 152
OS/SVS	- 153	VM/370	- 154	OS/MVS	- 155
DOS/VS	- 156				

THE FOLLOWING FIELD ENGINEERING FIELD SUPPORT LOCATIONS ARE RESPONSIBLE FOR SUPPORTING CLASS 'A' AND 'SCP' PROGRAMS AND THE FESER AS INDICATED:

<u>SUPP. CODE</u>	<u>LOCATION</u>	<u>SUPP. CODE</u>	<u>LOCATION</u>
01	ENDICOTT	27	BOCA RATON
02	POUGHKEEPSIE	62	HURSLEY
03	KINGSTON	63	LA GAUDE
10	ROCHESTER	64	BOEBLINGEN
13	SANTA TERESA	65	NORDIC LABS
23	RALEIGH	66	UITHOORN

*FOR FESER MAILING ADDRESSES, SEE PAGE 1-40

THE FOLLOWING DP/GSD/SDD SUPPORT LOCATIONS ARE RESPONSIBLE FOR SUPPORTING CLASS 'B' PROGRAMS AS INDICATED:

<u>SUPP. CODE</u>	<u>LOCATION</u>	<u>SUPP. CODE</u>	<u>LOCATION</u>
BR	BOCA RATON	PR	PARIS
CH	CHICAGO	RO	ROCHESTER
CR	CROYDON	ST	STUTTGART
LA	LOS ANGELES	TO	TOKYO
MP	MENLO PARK	WA	WASHINGTON
PA	PALO ALTO	WP	WHITE PLAINS
PK	POUGHKEEPSIE		

IMPORTANT

UNLESS OTHERWISE INDICATED IN THE FOLLOWING LIST, THE ORIGINAL AND GREEN COPIES OF THE APAR FORM SHOULD BE SENT TO THE ADDRESS SPECIFIED. RETAIN THE PINK COPY FOR YOUR FILES. THE BLUE COPY IS EXTRA AND CAN BE USED AS A WORKSHEET.

 *WHEN USING A PREPAID MAILING LABEL, BE SURE TO IN- *
 *CLUDE A RETURN ADDRESS ON THE OUTSIDE OF EACH APAR *
 *PACKAGE. FREQUENTLY, PACKAGES ARE RECEIVED WITHOUT A *
 *POSTMARK AND UNLESS THERE IS A RETURN ADDRESS, IBM *
 *WILL BE CHARGED THE MAXIMUM POSTAGE RATE. *

SOME PREPAID MAILING LABELS HAVE A DETACHABLE PORTION WHICH MUST BE FILLED OUT AND PLACED IN THE LOWER LEFT HAND CORNER OF THE PARCEL PRIOR TO MAILING. THIS INFORMATION WILL BE USED TO EXPEDITE DELIVERY OF THE APAR TO THE PROPER PROCESSING GROUP.

PROVIDE BOTH THE PRE-ASSIGNED APAR NUMBER AND THE ASSIGNED NUMBER (IF KNOWN) AT THE TIME OF SUBMISSION. PROVIDE THE ASSIGNED APAR NUMBER WHENEVER SUBMITTING ADDITIONAL INFORMATION.

INSTRUCTIONS FOR SUBMISSION OF APARS TO EUROPEAN
CHANGE TEAMS:

FOR NORMAL APAR SHIPMENTS, THAT IS WHEN THE EXPENSE OF HAVING IT EXPEDITED IS NOT WARRANTED, TO APAR ADDRESSES E,F,G,H,S AND CB THROUGH THE WORLD TRADE DISTRIBUTION CENTER FACILITIES, THE FOLLOWING PROCEDURE SHOULD BE FOLLOWED:

1. THE NORMAL APAR PRE-SCREENING PROCESS WILL BE FOLLOWED.
2. THE APAR MATERIAL MUST BE CONTAINED IN THE APAR MAILER BOX (FORM S229-2147) OR A SIMILAR CONTAINER - IT MUST BE BOXED. IF THE APAR MAILER BOX IS NOT USED, THE DIMENSIONS OF THE BOX SHIPPED (LENGTH, WIDTH, AND HEIGHT) MUST BE MARKED ON THE DESCRIPTIVE PORTION OF THE LABEL.
3. THE NEW PREPAID LABEL (FORM S229-3225) MUST BE COMPLETELY FILLED OUT AND AFFIXED TO THE APAR MAILER BOX. IF THE LABEL IS NOT AVAILABLE, THE ADDRESS AND DESCRIPTIVE INFORMATION MUST BE CLEARLY MARKED ON THE BOX.

RETURN ADDRESS:

IBM B/O _____ (STREET)
_____ (CITY, STATE, ZIP)

IBM WORLD TRADE CORPORATION
WORLD TRADE DISTRIBUTION CENTER, BLDG. 306
ATTN: RECEIVING DEPT.
EAST FISHKILL FACILITY, ROUTE 52
HOPEWELL JUNCTION, N.Y. 12533

4. THE FOLLOWING GUIDE IS TO BE USED WHEN COMPLETING THE DESCRIPTIVE PORTION OF THE LABEL:

	P/C		Q	U/Z/Y	Y
PRE AP_ _ _ _	32	TAPES	-	---	---
DATE SHIPPED_/_/_/_	71	CARDS	-	---	---
SHIP TO CODE_ _ _	71	PRINTED MAT.	-	---	---
PRG. ID_ _ _ _ _	32	DISK	-	---	---
	16	PTF	-	---	---
GROSS WEIGHT _____					---

1. PRE AP_ _ _ _ _; FILL IN THE BLANK WITH THE APAR PRE-ASSIGNED SERIAL NUMBER FROM THE APAR FORM BEING SUBMITTED.
2. DATE SHIPPED_/_/_/_; SUPPLY THE DATE THE PACKAGE IS MAILED BY THE PSR IN THE FORM Y/MM/DD.

3. SHIP TO CODE__ _; FILL IN THE SHIP TO CODE AS DESCRIBED BELOW:
 A) USING THE PSGIM, DETERMINE THE CHANGE TEAM CODE USED IN THE PREVIOUS APAR MAILING ADDRESS FOR THE COMPONENT.
 B) OBTAIN THE SHIP TO CODE FROM THE CHART BELOW:

MAIL ADDRESS	SHIP TO CODE
E	5U6
F	2F1
G	1G1
H	4N2
S	5S5
CB	5U6

- C) WRITE THE THREE DIGIT SHIP TO CODE IN THE SPACE PROVIDED ON THE SHIPPING LABEL.
 4. PROG. ID - - - - -; COMPLETE THIS FIELD BY INCLUDING THE PROG. ID OF THE COMPONENT BEING APARED.
 5. GROSS WEIGHT_____; ENTER THE WEIGHT OF THE PACKAGE IN POUNDS.
 6.

	Q	U/V	V
TAPES	---	-----	-----
CARDS	---	-----	-----
PRINTED MAT.	---	-----	-----
DISK	---	-----	-----
PTF	---	-----	-----

UNDER THE COLUMN LABELED Q, INDICATE THE QUANTITY OF EACH TYPE OF SUPPORTING DOCUMENTATION CONTAINED IN THE PACKAGE. IF THERE ARE NO ITEMS OF A PARTICULAR TYPE LISTED, THEN MARK THAT ROW WITH A ZERO IN EACH COLUMN.

UNDER THE COLUMN LABELED U/V, INDICATE THE UNIT VALUE OF EACH ITEM INCLUDED OF THIS TYPE. A VALUE MUST BE INCLUDED FOR EACH TYPE OF MATERIAL BEING SENT. ZERO MAY NOT BE USED IN THIS COLUMN, OR IN THE V COLUMN, UNLESS THE Q COLUMN FOR THAT TYPE IS ALSO ZERO.

THE FOLLOWING VALUES ARE TO BE USED IN THIS COLUMN:

	UNIT/VALUE
FOR TAPES: 2400 FT REEL	8
1200 FT REEL	6
SMALLER REEL	3
FOR CARDS:	1 FOR EACH DECK
PRINTED MATERIAL:	1 FOR EACH SEPARATE LISTING
FOR DISK PACKS: 1316	360
2316	525
2315	90
3336 MOD I	775
3336 MOD II	1150
3348 35 MEG	1600
3348 70 MEG	2200
3348 FIXED HEAD	4400
5400	175
FOR PTFs:	1 FOR EACH DECK

PAGE OF : G229-2228-20
REVISED : NOVEMBER 1977
BY TNL : GN25-0005-4

UNDER THE COLUMN LABELED V, INDICATE THE PRODUCT OF THE
VALUE CONTAINED IN COLUMN Q MULTIPLIED BY THE VALUE
CONTAINED IN COLUMN U/V.

*FOR CRITICAL OR POTENTIALLY CRITICAL APARS, THAT IS FOR *
*EXPEDITED SHIPMENTS TO APAR ADDRESSES E,F,G,H,S,AS AND CB *
*THROUGH THE WORLD TRADE DISTRIBUTION CENTER FACILITIES, THE *
*FOLLOWING PROCEDURE SHOULD BE FOLLOWED: *

1. THE NORMAL APAR PRE-SCREENING PROCESS WILL BE FOLLOWED.
2. THE APAR MATERIAL MUST BE CONTAINED IN THE APAR MAILER BOX (FORM S229-2147) OR A SIMILAR CONTAINER - IT MUST BE BOXED. IF THE APAR MAILER BOX IS NOT USED, THE DIMENSIONS OF THE BOX SHIPPED (LENGTH, WIDTH, AND HEIGHT) MUST BE MARKED ON THE DESCRIPTIVE PORTION OF THE LABEL.
3. THE DESCRIPTIVE PORTION OF THE NEW LABEL (FORM S229-3225) MUST BE COMPLETELY FILLED OUT, REFERENCE INSTRUCTIONS UNDER NORMAL APAR SHIPMENTS, AND AFFIXED TO THE APAR MAILER BOX (FORM S229-2147) AFTER THE ADDRESS PORTION HAS BEEN DETACHED AND DISCARDED. IF THE LABEL IS NOT AVAILABLE, THE ADDRESS AND DESCRIPTIVE INFORMATION MUST BE CLEARLY MARKED ON THE BOX.
4. LOCAL ARRANGEMENTS MUST BE MADE TO TRANSPORT THE APAR TO:

IBM WORLD TRADE CORPORATION
C/O UNIVERSAL TRANSCONTINENTAL CORPORATION
147-17 NEW YORK BLVD.
JAMAICA, NEW YORK 11434

IF THE APAR IS SHIPPED VIA AN AIRLINE TO JFK, THIS MAY BE BEST HANDLED BY UTILIZING ONE OF THE SPECIAL PROGRAMS THAT MOST AIRLINES HAVE FOR EXPEDITING THE SHIPMENT OF SMALL PACKAGES, THE AIR BILL SHOULD BE MARKED:

NOTIFY: UNIVERSAL TRANSCONTINENTAL CORP. UPON
ARRIVAL. TEL. NO. 212-995-7250

5. THE DESCRIPTIVE INFORMATION CONTAINED ON THE LABEL ALONG WITH THE FLIGHT INFORMATION (AIRLINE, FLIGHT NUMBER, ARRIVAL TIME AT JFK AIRPORT, AIR BILL NUMBER AND METHOD OF SHIPMENT - BAGGAGE OR FREIGHT) SHOULD BE GIVEN TO THE FIELD ENGINEERING TECHNICAL SUPPORT CENTER (FTSC) TO PASS ON TO FIELD ENGINEERING FIELD SUPPORT (FEFS) VIA THE CALL MANAGEMENT FACILITY OF RETAIN/370.

NOTE: THE REQUESTED INFORMATION MUST BE SUPPLIED AS SOON AS POSSIBLE. ANY DELAY OR DEVIATION FROM THIS PROCEDURE WILL RESULT IN A DELAY OF THE APAR SHIPMENT.

*ONLY LETTER SIZE ENVELOPES (4 1/8 X 9 1/2) MAY BE MAILED *
*DIRECT TO MAIL ADDRESS E,F,G,H,S AND CB, VIA AIR MAIL, *
*USING THE FOLLOWING ADDRESS: *
*

*MAIL ADDRESS POSTAL ADDRESS *

*	E	APAR PROCESSING	*
*		IBM UNITED KINGDOM LABORATORIES	*
*		PROGRAMMING CENTRE	*
*		HURSLEY PARK	*
*		WINCHESTER-S 021 2JN	*
*		HAMPSHIRE, ENGLAND	*
*			*
*	F	APAR PROCESSING D/293	*
*		COMPANIE IBM FRANCE	*
*		F-06610	*
*		LA GAUDE, FRANCE	*
*			*
*	G	APAR PROCESSING	*
*		IBM PROGRAMMING SYSTEM DEPT. 7921	*
*		P. O. BOX 210	*
*		D-7030 BOEBLINGEN, GERMANY	*
*			*
*	H	APAR PROCESSING	*
*		IBM LABORATORY CPSG D/266	*
*		P. O. BOX 24	*
*		UITHOORN, NETHERLANDS	*
*			*
*	S	APAR PROCESSING	*
*		IBM NORDISKA LABORATORIER	*
*		P. O. BOX 962	*
*		S-18109 LINDINQO 9, SWEDEN	*
*			*
*	CB	APAR PROCESSING	*
*		IBM UNITED KINGDOM LABORATORIES	*
*		MAILPOINT 189	*
*		HURSLEY PARK, WINCHESTER	*
*		HANTS, ENGLAND	*

INDICATE THE COMPONENT ID NUMBER AS WELL AS THE PRO-
GRAMMING SYSTEM ON THE DETACHABLE PORTION OF THE
LABEL. IF YOU DO NOT USE A PREPAID MAILING LABEL,
MARK THIS INFORMATION ON THE OUTSIDE OF THE PACKAGE.
FAILURE TO PROVIDE THIS INFORMATION WILL RESULT IN
UNNECESSARY DELAY IN THE DELIVERY OF YOUR APAR.

WORLD TRADE LOCATIONS SHOULD NOT USE THE UNIVERSAL TRANS-
CONTINENTAL CORPORATION OR THE PREPAID MAILER ADDRESS
WHEN MAILING APARS TO EUROPEAN SDD LOCATIONS.

PAGE OF : G229-2228-20
 REVISED : NOVEMBER 1977
 BY TNL : GN25-0005-4

PGM NO.	SVC CLS	FESN BASE	COMP	MAIL ADDR.	PROGRAM TITLE	SUPP CODE	FTSC GROUP
1130							
-ALL-	C	099	0038		-ALL 1130 PROGRAMS-		
14C1,1440,1450,1460,1500,1620							
-ALL-	C	099	0039		-ALL 1401,1440,1450,1460,1500 AND 1620 PROGRAMS-		
1800							
-ALL-	C	099	0039		-ALL 1800 PROGRAMS-		

360A							

CN-08X	C	099	0038		NUM CTL AUTOSPOT DOS		
CN-09X	C	099	0038		NUM CTL APT AUTO DOS		
CN-10X	C	099	0038		NUM CTL PROC APT OS		
CN-12X	C	099	0038		NUM CTL APT AUTO OS		
CO-18X	C	099	0038		LINEAR PGM SYS DOS		
CP-06X	C	099	0038		PROJ CNTL SYS DOS		
CX-12X	C	099	0038		DOC PROC SYS OS		
CX-15X	A	030	1509	AK	ASP SYS OS VERSION 2 13 ASP		
	A	030	1519	AK	ASP SYS OS VERSION 3 13 ASP		
CX-16X	C	099	0038		CONT SYS MODEL OS		
CX-17X	C	099	0038		RMT ACCESS COM BPS		
CX-18X	C	099	0038		ADMIN TERM SYS BOS		
CX-19X	C	099	0038		ADMIN TERM SYS OS		
CX-26X	C	099	0038		PROB LANG ANAL DOS		
CX-27X	C	099	0038		PROB LANG ANAL OS		
CX-32X	C	099	0038		DECIS LOG TRANS DOS		
CX-34X	C	099	0038		PLAN GRAPH SUP 2250		
CX-42X	C	099	0038		CALL/360 OS		
CX-44X	C	099	0038		CALL/360 BASIC OS		
CX-45X	C	099	0038		CALL/360 PL/1 OS		
CX-46X	C	099	0038		CALL/360 FORTRAN OS		
DP-07X	C	099	0038		TXT PROC HYPEN/360		
DP-08X	C	099	0038		TXT PROC COMP/360		
DR-04X	C	099	0038		RET IMPACT SYS FASH		
DR-05X	C	099	0038		RET IMPACT SYS STPL		
DR-07X	C	099	0038		1287 INPUT CONV DOS		
DR-08X	C	099	0038		RET IMPACT SYS FASH		
DR-09X	C	099	0038		RET IMPACT SYS STPL		
DW-05X	C	099	0038		WHLSALE IMPACT O/B		
EM-04X	C	099	0038		MECH DGN SYS KINEMAT		
EO-15X	C	099	0038		PGM OPT SYS DGN OS		
FB-15X	C	099	0038		DEMAND DEP ACCT BOS		
FB-16X	C	099	0038		ONLINE TELLER BOS		
FI-06X	C	099	0038		OPT BOND BID BOS		
IF-10X	C	099	0038		PROP-LIAB INFO BASIC		
IF-11X	C	099	0038		PROP-LIAB INFO AUTO		
IF-13X	C	099	0038		PROP-LIAB INFO OTHR		
ME-07X	C	099	0038		PROD STRUC RETR		
MF-04X	C	099	0038		INVEN CTRL DOS		
MF-05X	C	099	0038		REQ PLANNING DOS		
SC-01X	C	099	0038		COMM CNTL APPL PGM		
SE-15X	C	099	0038		DATA CONV PGM UTIL1		
SE-19X	C	099	0038		1400 AUTOCD COB CON		
SE-20X	C	099	0038		DATA CONV PGM UTIL2		
SE-22X	C	099	0038		FLOW CHART DOS		
SE-23X	C	099	0038		DATA CONV-LBL T/DOS		
SE-26X	C	099	0038		DATA CONV PGM UTIL3		
SE-32X	C	099	0038		SYN TR/REC ACC METH		
SE-33X	C	099	0038		SYN TR/REC ACC METH		
ST-06X	C	099	0038		VEHICLE SCHED DCS		
SV-001	C	099	0038		S/360 RTM		

PGM NO.	SVC CLS	FESN BASE	COMP	MAIL ADDR.	PROGRAM TITLE	SUPP CODE	FTSC GROUP
TX-011	C	099	0038		DOS ASM/7		
TX-012	C	099	0039		DOS PREP/7		
TX-013	C	099	0039		DOS FORMAT/7		
TX-014	C	099	0039		DOS MACLIB/BASIC		
TX-015	C	099	0039		DOS LINK/7		
TX-016	A	030	0169	AF	DOS MACLIB/RELOCATE	27	
TX-021	C	099	0039		OS ASM/7		
TX-022	C	099	0039		OS PREP/7		
TX-023	C	099	0039		OS FORMAT/7		
TX-024	C	099	0039		OS MACLIB/BASIC		
TX-025	C	099	0039		OS LINK/7		
TX-026	A	030	0269	AF	OS MACLIB/RELOCATE	27	
TX-032	C	099	0038		S/370/DSP/OS		
UH-08L	C	099	0038		MISP		
UH-11X	C	099	0038		SHRD HOSP ACCT SHAS		
US-06X	C	099	0038		STUD SCHED T-C MAT		
US-07X	C	099	0038		STUD SCHED SCHED		
UX-01X	C	099	0038		COURSEWRITER III		
360B							
-ALL-	C	099	0039		-ALL 360B PROGRAMS-		
360C							
-ALL-	C	099	0039		-ALL 360C PROGRAMS-		

360D							

051014	A	009	0149	AK	HASP	13	HASP
-REST-	C	099	0038		-ALL OTHER 360D PROGRAMS-		
NOTE - FOR RETAIN RETRIEVAL, OMIT THE FIRST CHARACTER TO THE RIGHT OF 360D. FOR EXAMPLE, RETAIN LABEL FOR 360D-05.1.014 IS 360D-51014.							
360F							
-ALL-	C	099	0039		-ALL 360F PROGRAMS-		
360G							
CL-627	C	099	0038		360/67 TSS		

360H							

TX-033	A	029	0339	BG	3705 EP SUPPORT	23	3705 PROG
TX-034	A	029	0349	AL	3705 NCPI FOR OS	23	3705 PROG
TX-035	A	029	0359	AL	3705 SSP FOR OS	23	3705 PROG
TX-036	C	099	0039		3705 SSP FOR DOS/360		
360M							
-ALL-	C	099	0039		-ALL 360M PROGRAMS-		

360N-DOS							

AS-465	C	099	0032		DOS/360 ASM BASIC		
AS-466	C	099	0032		DOS/360 ASM F		
CB-452	C	099	0032		DOS/360 COBOL		
CB-468	C	099	0032		DOS/360 CBL DASD MAC		
CB-482	C	099	0032		DOS/360 ANS COBOL		
CL-453	C	099	0032		DOS/360 SYS CTL BA		
CQ-469	C	099	0032		DOS/360 BTAM		
CQ-470	C	099	0032		DOS/360 QTAM		
CQ-493	C	099	0032		3735 MACROS/UTIL.		
CV-489	C	099	0039		COBOL LCP		
DN-481	C	099	0032		DOS/360 OLTEP		
EU-484	C	099	0032		DOS/360 14XX EM CMP		
EU-485	C	099	0032		DOS/360 14XX EM CMP		

PAGE OF : G229-2228-20
 REVISED : NOVEMBER 1977
 BY TNL : GN25-0005-4

PGM NO.	SVC CLS	FESN BASE	COMP	MAIL ADDR.	PROGRAM TITLE	SUPP CODE	FTSC GROUP
EU-490	C	099	0032		14XX EMUL S/370		
FD-451	C	099	0032		DOS/360 FORTRAN IV		
FG-479	A	002	4799	AK	DOS/360 FORTRAN IV	13	FORTRAN
		042	4799	AK	RELEASE 27 AND ABOVE	13	FORTRAN
IC-001	C	099	0032		DOS/360 2596		
IC-002	C	099	0032		DOS/BTAM 3270/3735		
IC-003	C	099	0039		MACROS AND UTIL SUPP		
	C	099	0039		RELEASE 27 AND ABOVE		
IO-454	C	099	0032		DOS/360 DA METHOD		
IO-455	C	099	0032		DOS/360 CONS DISK		
IO-456	C	099	0032		DOS/360 CONS TAPE		
IO-457	C	099	0032		DOS/360 ISFMS		
IO-458	C	099	0032		DOS/360 CONS PT		
IO-476	C	099	0032		DOS/360 CMPL IO MOD		
IO-477	C	099	0032		DOS/360 1259/1412/19		
IO-478	C	099	0032		DOS/360 OCR		
LM-480	A	002	4809	AK	DOS/360 FORT4 LIB	13	FORTRAN
		042	4809	AK	RELEASE 27 AND ABOVE	13	FORTRAN
PL-464	C	099	0032		DOS/360 PL/1		
PT-459	C	099	0032		AUTOTEST		
RG-460	C	099	0032		DOS/360 RPG		
SM-400	C	099	0032		DOS/360 SRT/MKGE IP		
SM-450	C	099	0032		DOS/360 S/MRG DK/TP		
SM-483	C	099	0032		DOS/360 S/MRG 2314		
SV-474	C	099	0032		DOS/360 SPR 6K 2311		
SV-486	C	099	0032		DOS/360 SPR 8K 2311		
UT-461	C	099	0032		DOS/360 GP1 UTIL		
UT-462	C	099	0032		DOS/360 GP2 UTIL		
UT-463	C	099	0032		DOS/360 GP3 UTIL		
UT-471	C	099	0032		DOS/360 MPS UTIL MAC		
UT-472	C	099	0032		DOS/360 VOC FILE UT		

360P

UT-213	A	004	2139	AK	OS/360 DASDI	13	UTILITY
UT-214	A	004	2149	AK	OS/360 DUMP RESTR	13	UTILITY
UT-215	A	004	2159	AK	OS/360 RECOVERY	13	UTILITY
-REST-	C	099	0033		-ALL OTHER 360P PROGRAMS		
					-BASIC PROG SYS-		

*360S-OS-CLASS C 11/30/77 *

AL-531	C	099	0039		ALGOL F		
AS-036	C	099	0031		ASSEMBLER E 18X		
AS-037	C	099	0039		ASSEMBLER F		
CA-505	C	099	0039		MFT DISK ERP		
CA-535	C	099	0039		MVT DISK ERP		
CA-555	C	099	0039		TSD DISK ERP		
CA-566	C	099	0031		PCP DISK ERP		
CB-505	C	099	0039		MFT UNIT REC ERP		
CB-535	C	099	0039		MVT UNIT REC ERP		
CB-545	C	099	0031		ANS COBOL VER I		
CB-555	C	099	0039		TSD UNIT REC ERP		
CB-566	C	099	0031		PCP UNIT REC ERP		
CC-505	C	099	0039		MFT TP ERP		
CC-535	C	099	0039		MVT TP ERP		
CC-555	C	099	0039		TSD TP ERP		
CC-566	C	099	0031		PCP TP ERP		
CD-505	C	099	0039		MFT 1419-1275 ERP		
CD-535	C	099	0039		MVT 1419-1275 ERP		
CD-555	C	099	0039		TSD 1419-1275 ERP		
CD-566	C	099	0031		PCP 1419-1275 ERP		
CE-505	C	099	0039		MFT 12XX ERP		
CE-535	C	099	0039		MVT 12XX ERP		
CE-555	C	099	0039		TSD 12XX ERP		

PGM NO.	SVC CLS	FESN BASE	COMPT	MAIL ADDR.	PROGRAM TITLE	SUPP CODE	FTSC GROUP
	CE-566	C	099	0031	PCP 12XX ERP		
	CF-505	C	099	0039	MFT 2495 ERP		
	CF-535	C	099	0039	MVT 2495 ERP		
	CF-555	C	099	0039	TSO 2495 ERP		
	CF-566	C	099	0031	PCP 2495 ERP		
	CG-505	C	099	0039	MFT CHKPOINT RESTART		
	CG-535	C	099	0039	MVT CHKPOINT RESTART		
	CG-555	C	099	0039	TSO CHKPOINT RESTART		
	CG-566	C	099	0031	PCP CHKPOINT RESTART		
	CI-514	C	099	0039	STARTER SYSTEM		
	CI-534	C	099	0039	STARTER SYS/2314		
	CI-555	C	099	0039	DS/360 UTILITIES		
	CK-555	C	099	0039	TSO TIOC		
	CL-555	C	099	0039	LINK LOADGO PROMPTER		
	CN-505	C	099	0039	SMF SAMPLIB PARMLIB		
	CN-535	C	099	0039	SMF SAMPLIB PARMLIB		
	CO-503	C	099	0031	COBOL E		
	CP-505	C	099	0039	MFT GTF		
	CP-535	C	099	0039	MVT GTF		
	CP-555	C	099	0039	TSO GTF		
	CQ-513	C	099	0039	BTAM-2740 MCS		
	CQ-519	C	099	0031	QTAM		
	CQ-563	C	099	0031	3735 MACROS AND UTIL		
	C1-548	C	099	0039	TCAM		
	C2-505	C	099	0039	SUPERVISOR MFT		
	C2-535	C	099	0039	SUPERVISOR MVT		
	C2-548	C	099	0039	TSO TCAM		
	C2-555	C	099	0039	SUPERVISOR TSO		
	C2-566	C	099	0031	SUPERVISOR PCP		
	C3-505	C	099	0039	IOS MFT		
	C3-535	C	099	0039	IOS MVT		
	C3-548	C	099	0039	TOTE		
	C3-555	C	099	0039	IOS TSO		
	C3-566	C	099	0031	IOS PCP		
	C4-505	C	099	0039	MFT GRAPH OPR SUPP		
	C4-535	C	099	0039	MVT GRAPH OPR SUPP		
	C4-548	C	099	0039	TSO TCAM SUBROUTINES		
	C4-555	C	099	0039	TSO GRAPH OPR SUPP		
	C4-566	C	099	0031	PCP GRAPH OPR SUPP		
	C5-505	C	099	0039	MFT SCHED		
	C5-535	C	099	0039	MVT SCHED		
	C5-555	C	099	0039	TSO SCHED		
	C5-566	C	099	0031	PCP SCHED		
	C6-505	C	099	0039	MFT LKED OVLY SUPVR		
	C6-535	C	099	0039	MVT LKED OVLY SUPVR		
	C6-555	C	099	0039	TSO LKED OVLY SUPVR		
	C6-566	C	099	0031	PCP LKED OVLY SUPVR		
	C7-505	C	099	0039	MFT SYSOUT WRITER		
	C7-535	C	099	0039	MVT SYSOUT WRITER		
	C7-555	C	099	0039	TSO SYSOUT WRITER		
	C7-566	C	099	0031	PCP SYSOUT WRITER		
	C9-505	C	099	0039	MFT SYSGEN MACROS		
	C9-535	C	099	0039	MVT SYSGEN MACROS		
	C9-555	C	099	0039	TSO SYSGEN MACROS		
	C9-566	C	009	0039	PCP SYSGEN MACROS		
	DN-509	C	099	0039	BDAM		
	DN-527	C	099	0039	SERO/1/OBR/EREPO		
	DN-533	C	099	0039	QLTEP		

PAGE OF : G229-2228-20
 REVISED : NOVEMBER 1977
 BY TNL : GN25-0005-4

PGM NO.	SVC CLS	FESN BASE COMP	MAIL ADDR.	PROGRAM TITLE	SUPP CODE	FTSC GROUP
DN-539	C	099	0039	RECOVERY MGMT M65		
DN-611	C	099	0039	HMASMP		
DN-614	C	099	0039	POWER WARNING FEAT		
D1-508	C	099	0039	OPEN/CLOSE/EOV		
D1-527	C	099	0039	155 ERROR RECOVERY		
D1-554	C	099	0039	IMDSADMP		
D2-508	C	099	0039	ACCESS METHODS		
D2-554	C	099	0039	IMDPRDMP		
D3-508	C	099	0039	CATALOG		
D3-554	C	099	0039	IMASPZAP		
D4-508	C	099	0039	DAOSM		
D4-554	C	099	0039	IMAPTFILE		
D5-508	C	099	0039	OPT/RDR 12XX		
D5-554	C	099	0039	IMCJODMP		
D6-508	C	099	0039	RDR 1419/1275		
D6-554	C	099	0039	IMAPTFLS		
D7-508	C	099	0039	DM CHKPT RESTART		
D7-554	C	099	0039	IMBMDMAP		
D8-508	C	099	0039	2245-3211 SUPPORT		
D8-554	C	099	0039	IMBLIST		
D9-508	C	099	0039	3505-3523 SUPPORT		
ED-510	C	099	0039	LKED E 15K,18K		
ED-521	C	099	0039	LKED F		
FO-092	C	099	0039	FORTRAN E 15K		
FO-500	C	099	0039	FORTRAN 4 H		
FO-520	C	099	0039	FORTRAN 4 G		
FO-550	C	099	0039	FORTRAN SYNTAX CHK		
IO-523	C	099	0039	GRAPH PGM SVCS		
IO-526	C	099	0039	ISAM		
LD-547	C	099	0039	LOADER		
LM-501	C	099	0039	FORTRAN LIBRARY		
LM-504	C	099	0039	COBOL E LIBRARY		
LM-512	C	099	0039	PL/1 SUB LIBRARY		
LM-532	C	099	0039	ALGOL F LIBRARY		
LM-537	C	099	0039	GRAPH SUB PGM		
LM-542	C	099	0039	1130/360 DATA TRANS		
LM-546	C	099	0039	USA STAND COBOL LIB		
NL-511	C	099	0039	PL/1 F		
PL-552	C	099	0039	PL/1 SYNTAX CHK		
PT-516	C	099	0039	TESTRAN		
RC-536	C	099	0039	RJE		
RC-541	C	099	0039	GRAPH JOB PROC		
RC-543	C	099	0039	SATE GRAPH JOB		
RC-551	C	099	0039	CRJE		
RG-038	C	099	0039	RPG		
SM-023	C	099	0039	SORT/MERGE		
UA-506	C	099	0039	IEBEDIT		
UB-506	C	099	0039	IEBUPDAT		
UC-506	C	099	0039	IEBCOMPR		
UD-506	C	099	0039	IEHIOSUP		
UE-506	C	099	0039	IHGUAU		
UF-506	C	099	0039	IEHUCSLD		
UG-506	C	099	0039	IEBTCRIN		
UH-506	C	099	0039	IEHATLAS		
UJ-506	C	099	0039	IFHSTATR		
UK-506	C	099	0039	IEHDSADR		
UL-506	C	099	0039	TSD EDIT		
UM-506	C	099	0039	TSD UTILITIES		
UN-506	C	099	0039	TSD UTIL COMMANDS		
UP-506	C	099	0039	TSD UTIL OUTPUT		
UT-506	C	099	0039	OS/360 UTILITIES		

PGM NO.	SVC CLS	FESN BASE	COMP	MAIL ADDR.	PROGRAM TITLE	SUPP CODE	FTSC GROUP
UT-507	C	099	0039		INDEPENDENT UTIL		
UT-558	C	099	0039		IEHMAN		
U1-506	C	099	0039		IEHMOVE		
U2-506	C	099	0039		IEBUPDTE		
U2-507	C	099	0039		IBCDMPRS		
U3-506	C	099	0039		IEBCOPY		
U3-507	C	099	0039		IBCDASDI		
U4-506	C	099	0039		IEBGENR		
U4-507	C	099	0039		IBCRVPR		
U5-506	C	099	0039		IEHLIST		
U5-507	C	099	0039		ICAPRTBL		
U6-506	C	099	0039		IEBISAM		
U7-506	C	099	0039		IEHPRGM		
U8-506	C	099	0039		IEBTPCH		
U9-506	C	099	0039		IEHINITT		
U0-506	C	099	0039		IEBDG		

360T, 360U, 360V, 360W							

-ALL-	C	099	0038		-ALL 360T PROGRAMS-		
-ALL-	C	099	0038		-ALL 360U PROGRAMS-		
-ALL-	C	099	0038		-ALL 360V PROGRAMS-		
-ALL-	C	099	0038		-ALL 360W PROGRAMS-		

370H							

TX-001	A	028	0019	AK	HASP II VERSION 4	13	HASP

370N-DOS							

AS-465	C	099	0039		DOS/370 ASSEMBLER		
CL-453	C	099	0039		DOS/370 SYS CTL BA		
CQ-469	C	099	0039		DOS/370 BTAM		
CQ-470	C	099	0039		DOS/370 QTAM		
CQ-493	C	099	0039		DOS/370 3735 TRM SUP		
DN-481	C	099	0039		DOS/370 DLTEP		
EU-490	C	099	0039		DOS/370 14XX EMUL		
IC-001	C	099	0039		3275 SWITCHED SUPPT		
IC-002	C	099	0039		DOS/370 MOD 20 EM		
IC-003	C	099	0039		3735 TERMINAL SUPT		
IC-004	C	099	0039		MODEL 125 SUPT		
IO-454	C	099	0039		DOS/370 DA METHOD		
IO-455	C	099	0039		DOS/370 CONS DISK		
IO-456	C	099	0039		DOS/370 CONS TAPE		
IO-457	C	099	0039		DOS/370 ISFMS		
IO-458	C	099	0039		DOS/370 CONS PT IOCS		
IO-476	C	099	0039		DOS/370 CMPL IO MOD		
IO-477	C	099	0039		DOS/370 1259/1412/19		
IO-478	C	099	0039		DOS/370 OCR		
SV-495	C	099	0039		DOS/370 2311/14/3330		
UT-491	C	099	0039		DOS/370 SYS UTIL PRG		
UT-492	C	099	0039		DOS/370 EREP		

370S							

DL-002		310	0029	AH	DATA LINK SOFTWARE		

PAGE OF : G229-2228-20
 REVISED : NOVEMBER 1977
 BY TNL : GN25-0005-4

PGM NO.	SVC CLS	FESN BASE	MAIL COMP	PROGRAM TITLE	SUPP CODE	FTSC GROUP
NO.			ADDR.			

5701-SYS/3-MOD 10 (CARD SYSTEM)						

D11	C	099 0038		S/3 UNIT INV TECH		
D12	C	099 0038		APPAREL BUS CTRL		
D51	C	099 0038		S/3 OPT BLNDG		
G21	C	099 0038		S/3 LAW ENFORCE SYS		
G22	C	099 0038		S/3 APPROP ACTG SYS		
G23	C	099 0038		S/3 CITA PROC SYS		
G24	C	099 0038		S/3 UTIL BILL SYS		
M41	C	099 0038		S/3 ORDER PT TECH		
M42	C	099 0038		S/3 CARD BILL MATL		
N21	C	099 0038		S/3 P&L AGENCY SYS		
RG1	C	099 0038		S/3 CARD RPG II		
SC1	SCP	161 0009	AP	S/3 CARD SYSTEM	10	
SM1	C	099 0038		S/3 TAPE SORT		
UT1	C	099 0039		S/3 CARD SYS UTIL		

5702-SYS/3 MOD 10 (DISK SYSTEM)						

AS1	A	262 0369	AP	S/3 BASIC ASSM	10	
CB1	A	262 2559	AP	S/3 ANS COBOL	10	
F01	A	262 2569	AP	S/3 FORTRAN IV	10	
K11	B	099 0028	AB	S/3 FOR TV AND RADIO	CH	
M41	B	099 0028	AB	S/3 BM PROC	CH	
M52	B	099 0028	AB	S/3 INV RQMNTS PLNG	CH	
P21	C	099 0038		PROCPU MODEL 10		
RG1	A	262 0379	AP	S/3 DISK RPG II	10	
SC1	SCP	162 0019	AP	S/3 DISK SYSTEM	10	
		162 1039	AP	S/3 C.C.P. FEATURE	10	
		162 1059	AP	S/3 M.R.J.E. FEATURE	10	
SM1	A	262 0389	AP	S/3 DISK SORT	10	
SM2	C	099 0038		S/3 TAPE SORT		
UT1	A	262 0399	AP	S/3 CARD UTIL	10	
UT2	A	262 1669	AP	S/3 1255 UTIL	10	
XN1	C	099 0038		APT-BC		
XP1	B	099 0028	N	JAS/3	WP	
XX1	B	099 0028		DATA/3 LOGIC		

5703-SYS/3-MOD 4 & 6						

F01	A	263 3479	AP	S/3 FORTRAN IV	10	
N11	B	099 0028		HEALTH,WELF,PENS FND	WP	
P21	C	099 0038		PROCPU MODEL 6		
IL-09X	C	099 0038		ADV LIFE INFO S/DOS		
ME-06X	C	099 0038		BM PROC B/DOS		
RG1	A	263 1729	AP	S/3 DISK RPG II	10	
SC1	SCP	163 0039	AP	S/3 DISK SYSTEM	10	
		163 1069	AP	S/3 M.R.J.E. FEATURE	10	
		163 1089	AP	S/3 CCP FEATURE	10	
SM1	A	263 1739	AP	S/3 DISK SORT	10	
SM2	A	263 1759	AP	S/3 CCP/DISK SORT	10	
UT1	A	263 1749	AP	S/3 CONV UTIL	10	
UT2	C	099 0039		S/3 1255 UTIL		
XA1	C	099 0038		STAT/BASIC		
XM1	C	099 0038		S/3 BASIC		
XM2	B	099 0028	BL	S/3 MOD 6 MATH/BASIC	13	
XM3	C	099 0038		S/3 M6 BUS ANL/BASIC		

PGM NO.	SVC	FESN	MAIL	PROGRAM TITLE	SUPP CODE	FTSC GROUP
	CLS	BASE	COMP	ADDR.		

5704-SYS/3-MOD 15 (A,B,C)						

AS1	A	264	3619	AP BASIC ASSM		10
CB1	A	264	3599	AP ANS COBOL		10
FO1	A	264	3609	AP FORTRAN IV		10
RG1	A	264	3589	AP RPG II		10
SC-1	SCP	164	0879	AP DISK SCP		10
		164	1019	AP CCP FEATURE		10
		164	1079	AP M.R.J.E. FEATURE		10
SM1	A	264	3629	AP DISK SORT		10
SM2	A	264	3639	AP TAPE SORT		10
UT1	A	264	3649	AP UTILITIES		10
XX1	B	099	0028	DATA/3 LOGIC		

5704-SYS/3-MOD 15D						

AS2	A	264	3659	AP BASIC ASSEM		10
CB2	A	264	3669	AP ANS COBOL		10
FO2	A	264	3679	AP FORTRAN IV		10
RG2	A	264	3689	AP RPG II		10
SC2	S	164	1089	AP DISK SCP		10
		164	1099	AP CCP FEATURE		10
		164	1109	AP M.R.J.E. FEATURE		10
SM7	A	264	3709	AP CCP/DISK SORT		10
SM8	A	264	3719	AP TAPE SORT		10
SM9	A	264	3699	AP DISK SORT		10
UT3	A	264	3729	AP UTILITIES		10

5705-SYS/3-MOD 12						

AS1	A	265	0059	AP BASIC ASSM		10
CB1	A	265	0039	AP COBOL		10
FO1	A	265	0049	AP FORTRAN IV		10
RG1	A	265	0029	AP RPGII		10
SC1	SCP	165	0019	AP DISK SCP		10
		165	0029	AP CCP FEATURE		10
		165	0039	AP MRJE FEATURE		10
SM1	A	265	0069	AP DISK SORT		10
SM2	A	265	0079	AP TAPE SORT		10
UT1	A	265	0089	AP UTILITIES		10
UT2	A	265	0099	AP 1255 UTILITIES		10

5707-SYS/7						

AA1	SCP	151	0900	AF SYS/7 PPF		27
AB1	SCP	151	0919	AF MSP/7 PROCLIB		27
AC1	SCP	151	0929	AF MSP/7 SYSCODE		27
AD1	SCP	151	0939	AF MSP/7 ASM/7		27
AE1	SCP	151	0949	AF MSP/7 SLE		27
AF1	SCP	151	0959	AF MSP/7 LINK/7		27
AG1	SCP	151	0969	AF MSP/7 DSS/7 8-12K		27
FO1	A	251	3679	AF MSP/7 FORT IV		27
F12	B	099	0028	GRAPHICS FEAT		
LM1	C	099	0038	APPL MODULE LIB/7		
M31	C	099	0038	MMS OS/VS		
M32	C	099	0038	MMS DOS/VS		
M33	B	099	0028	G MMS OS/VS V 2		ST
M34	B	099	0028	G MMS DOS/VS V 2		ST
RC1	C	099	0038	CCAP/7		
RC2	B	099	0028	V CCAP/7 VER 2		WA
SC2	SCP	151	0449	AF MSP/7 DSS/7		27

PAGE OF : G229-2228-20
 REVISED : NOVEMBER 1977
 BY TNL : GN25-0005-4

PGM NO.	SVC	FESN	MAIL	PROGRAM TITLE	SUPP	FTSC
	CLS	BASE	COMP	ADDR.	CODE	GROUP
T12	B	099	0028	N ACD-MONITOR		WP
U11	B	099	0028	ENERGY MGMT SYSTEM		
XC1	B	099	0028	APG/7		
XN3	C	099	0038	PCP/7 OS		
XN4	C	099	0038	PCP/7 DOS		
XN5	C	099	0038	PCP/7 PREP		
XR1	C	099	0038	TGS/7		

5711-1130

-ALL- C 099 0038 -ALL 1130 PROGRAMS-

5718-1800

H11	C	099	0038	1800 CLDAS		
H12	C	099	0038	1800 CLMS		
P81	C	099	0038	PROSPRO II		
RG1	C	099	0038	1800 RPG		
SC2	SCP	151	*	AF S/7 SCP		27
*USE THE FOLLOWING COMPONENT NUMBERS FOR						
BASE NUMBER 151						
0051 IPL/LOADER						
0052 ASSEMBLER						
0053 UTILITIES						
0054 SUBROUTINES						
0055 SAMPLE PROGRAM						
XX1	C	099	0038	1800 CHROMA MON.		

5719-SERIES/1

AS1	319	0010	AE	PROG PREP SUBSYSTEM		27
AS-1AB	319	0010	AE	APPLICATION BUILDER		27
AS-1IN	319	0010	AE	PROG PREP INSTALL		27
AS-1JS	319	0010	AE	JOB STREAM PROCESSOR		27
AS-1MA	319	0010	AE	MACRO ASSEMBLER		27
AS-1TE	319	0010	AE	TEXT EDITOR		27
F01	319	3931	AE	FORT COMP & OBJ LIB		27
F03	319	3933	AE	FORT REALTIME SUB LIB		27
LM1	319	3941	AE	MFSL		27
PC1	319	0011	AE	REALTIME PROG SYSTEM		27
PC-1CM	319	0011	AE	COMMUNICATIONS		27
PC-1DM	319	0011	AE	DATA MANAGEMENT		27
PC-1SG	319	0011	AE	SYSTEM GENERATION		27
PC-1SS	319	0011	AE	SUPERVISOR		27
PC-1UT	319	0011	AE	UTILITIES		27
PL1	319	3951	AE	PL/1 COMP & RES LIB		27
PL3	319	3953	AE	PL/1 TRANSIENT LIB		27
SC2 SCP	119	3911	AE	STANDALONE UTILITIES		27
U11	219	3911	BO	FC/PM1		27
U12	219	3912	BO	FC/PM2		27
	219	3913	BO	FC/PM3		27
	219	3914	BO	APPU		27

PGM ND.	SVC CLS	FESN BASE	MAIL COMP	MAIL ADDR.	PROGRAM TITLE	SUPP CODE	FTSC GROUP

5725-SYSTEM/32							

RG-1AR	A	225	3709	CC	RPG II AUTO REPORT	10	
RG-1BS	A	225	3709	CC	RPG II BSC SUPPORT	10	
RG-1RG	A	225	3709	CC	RPG II COMPILER	10	
SC-1BA	SCP	125	1040	CC	\$BACK BACKUP LIB UTL	10	
SC-1BI	SCP	125	1040	CC	\$BICR INTRCHG UTL	10	
SC-1BS	SCP	125	1040	CC	BSC IDS	10	
SC-1BW	SCP	125	1070	CC	BWS/SNA/SDLC	10	
SC-1BU	SCP	125	1040	CC	\$BUILD ALT SECT ASSG	10	
SC-1CE	SCP	125	1040	CC	CE DIAG AIDS	10	
SC-1CN	SCP	125	1040	CC	CNFIGSCP SCP INSTALL	10	
SC-1CO	SCP	125	1040	CC	\$COPY DISK COPY UTL	10	
SC-1CS	SCP	125	1040	CC	CNTL STORE UCODE	10	
SC-1DE	SCP	125	1040	CC	\$DELET FILE DELETE	10	
SC-1DM	SCP	125	1040	CC	DATA MANAGEMENT	10	
SC-1DU	SCP	125	1040	CC	\$DUPRD DISKETTE COPY	10	
SC-1HI	SCP	125	1040	CC	\$HIST HISTORY DISP	10	
SC-1IN	SCP	125	1040	CC	\$INIT DISKETTE INIT	10	
SC-1LA	SCP	125	1040	CC	\$LABEL VTDC DISPLAY	10	
SC-1LE	SCP	125	1040	CC	LINKAGE EDITOR	10	
SC-1LO	SCP	125	1040	CC	\$LOAD RELOAD LIB	10	
SC-1MA	SCP	125	1040	CC	\$MAINT LIB MAINT	10	
SC-1MG	SCP	125	1040	CC	\$MGBLD CREATE MSG	10	
SC-1MR	SCP	125	1050	CC	MRJE	10	
SC-1PA	SCP	125	1040	CC	\$PACK DISK REORG	10	
SC-1RE	SCP	125	1040	CC	\$REBLD REBUILD DATA	10	
SC-1SE	SCP	125	1040	CC	\$SETCF SET UTL	10	
SC-1SH	SCP	125	1040	CC	SCHEDULER	10	
SC-1ST	SCP	125	1040	CC	\$STATS STATUS DISP	10	
SC-1US	SCP	125	1040	CC	\$USDD SYNTAX CHECK	10	
SC-1WP	SCP	125	1060	DA	WORD PROCESSING FEAT	10	
UT-1DS	A	225	3719	CC	DISK SORT	10	
UT-1DF	A	225	3729	CC	DATA FILE UTL	10	
UT-1SE	A	225	3739	CC	SOURCE ENTRY UTL	10	
XX-1WP	A	225	3759	DB	WORD PROCESSOR/32	10	

PAGE OF : G229-2228-20
 REVISED : NOVEMBER 1977
 BY TNL : GN25-0005-4

PGM NO.	SVC CLS	FESN BASE	MAIL COMP	MAIL ADDR.	PROGRAM TITLE	SUPP CODE	FTSC GROUP

5734-OS/V5 PP							

AS-100	C	099	0039		ASSEMBLER H		
CB-101	C	099	0039		FULL ANS COBOL V3		
CB-202	A	2**	1449	AK	OS FULL ANS COBOL V4	13	COBOL
CB4	B	099	0028	AK	COBOL INTER DEBUG		WP
CP-101	A	2**	1469	AK	TSO COBOL PROMPTER	13	COBOL
CP-201	C	099	0039		TSO ASSEMBLER PROMPT		
CP-301	C	099	0038		TSO FORTRAN PROMPTER		
CP4	C	099	0038		ALGOL-F PROMPTER		
D32	C	099	0038		OS COGS ALLOCATION		
D33	C	099	0038		OS COGS FORECAST		
EE1	C	099	0038		ELEC CKT ANAL PGM II		
E12	C	099	0038		COURSE WRITER III V2		
E13	B	099	0028	V	CRSWRTR III OS V3		WP
FO-101	C	099	0039		CODE AND GO FORTRAN		
FO-201	A	2**	1509	AK	FORTAN IV G1 COMP	13	FORTAN
FO-301	A	2**	1479	AK	FORTAN IV H EXT CMP	13	FORTAN
FO-401	A	251	3009	AF	OS FORT/7	27	FORTAN
F05	B	099	0028	AK	FORTAN INTER DEBUG		WP
F11	B	099	0028	N	CHECK PROC CTRL SYS		WP
F31	B	099	0028	AC	TELECOMM CTL TCS		WP
F32	B	099	0028	AC	SEC ORDER MATCH		WP
F34	B	099	0028	N	REGISTERED REP SYS		WP
F51	C	099	0038		BUDPLAN OS - WTC		
G21	C	099	0038		OS FASTER MT		
H11	B	099	0028	N	ECG ANALYSIS/OS		WP
LM-101	C	099	0039		FORTAN IV LIB MOD 1		
LM-201	A	2**	1449	AK	COBOL V4 LIB ONLY	13	COBOL
LM-301	A	2**	1489	AK	FORTAN IV LIB MOD 2	13	FORTAN
LM-441	A	2**	1919	AK	OS PL/1 RESIDENT LIB	13	PL1
LM-541	A	2**	1929	AK	OS PL/1 TRANS LIB	13	PL1
M31	C	099	0038		OS/360 SHOP FL CTRL		
M41	B	099	0028	AB	OS/360 CAPOSS		ST
M51	C	099	0038		OS/360 REQUIRE PLAN		
M52	C	099	0038		OS/360 INVENTORY CTR		
M53	C	099	0038		OS CAP PLAN INFINITE		
M54	C	099	0038		OS CAP PLAN FINITE		
PL-141	A	2**	1949	AK	OS PL/1 OPT COMP	13	PL1
PL-241	A	2**	1679	AK	OS PL/1 CHECKOUT CMP	13	PL1
RC-102	C	099	0038		OS-ITF PL1		
RC-202	C	099	0038		TSO-ITF PL1		
RC-302	C	099	0038		OS-ITF BASIC		
RC-402	C	099	0038		TSO-ITF BASIC		
RC-500	A	2**	2389	E	OS/VIDEO/370	62	VIDEO 370
SM-102	C	099	0039		OS SORT/MERGE 1		
UT-101	C	099	0039		TSO DATA UTILITIES		
UT2	C	099	0038		OS OS UTIL W/ASCII		
UT3	C	099	0038		OS BASIC UNIFORM RD		
XA2	C	099	0038		STAFOS		
XA3	B	099	0028	BL	STAT/BASIC	13	
XC3	B	099	0028	BD			MP
XC4	B	099	0028		OS/DMS-3270		
XMB	B	099	0028	BL	BUS ANAL/BASIC ITF	13	
XMC	C	099	0038		MGRW		
XM1	B	099	0028	AK	APL OS	13	
XM3	C	099	0038		PL/MATH		
XM4	B	099	0028	N	MPSX/GUB		WP
XM5	C	099	0038		VEHICLE SCHED PROG		
XM-641	C	099	0039		APL OS		

** - RECORD THE OPERATING SYSTEM OF PROGRAM PRODUCT:
 DO NOT USE 042 FOR DOS REGARDLESS OF THE RELEASE LEVEL
 OS & OTHER - 01, OS/V51 - 52, SVS - 53, MVS - 55,
 VM/370 - 54, DOS - 02, DOS/V5 - 56

PGM NO.	SVC CLS	FESN BASE	COMP	MAIL ADDR.	PROGRAM TITLE	SUPP CODE	FTSC GROUP
XM8	B	099	0028	BL	MATH/BASIC ITF		
XP3	C	099	0038		MINIPERT		
XP4	B	099	0028	N	PROG MGMT SYS OS	WP	
XR2	C	099	0038		DECTAT		
XR3	C	099	0038		STAIRS		
XS2	C	099	0038		GPSS V OS		
XS3	C	099	0038		DATA 360 OS		
XS7	C	099	0038		FAMS OS		
XS8	C	099	0038		DATA/360 OS		
XS9	C	099	0038		CSMP III		
XXB	C	099	0038		SIMPL/I - WTC		
XXC	B	099	0028	N	ITS/OS	WP	
XX-100	A	2**	0789	AK	GIS/2.2	13	GIS
XX2	C	099	0038		S/360 GATD OS		
XX-634	A	2**	0999	AK	IMS/360 V2 DATA BASE	13	IMS
					IMS/360 V2 DATA COMM	13	IMS
XX-635	A	2**	0999	AK	IQF/IMS	13	IMS
XX-701	A	2**	3019	CB	CICS/OS-STANDARD V2	13	CICS-US
				BW	FERS	03	
XX8	C	099	0038		LEARN ATS-OS		
XX9	C	099	0038		IMS/BOMP BRIDGE		

5735							

ICV1	B	099	0028	G	DOS/VS RPGII CONV	64	
E91	C	099	0038		EPIC - SOCRATES 3881		
E92	C	099	0038		EPIC - FAST		
E93	C	099	0038		EPIC - BUDGET/FIN		
E94	C	099	0038		EPIC - STUDENT		
SC1	SCP	135	0329	BG	EP SUPPORT VS	23	3705 PROG
SC2	SCP	135	0309	AL	NCP2 SUPPORT VS	23	3705 PROG
SC3	SCP	135	0709	AL	NCP3 SUPT DGS/OS/VS	23	3705 PROG

5736-DOS DOS/VS PP							

CB-102	C	099	0038		DOS ANS SUBSET COBL		
CB-201	A	202	2049	G	DOS/FULL ANS COBL V3	64	COBOL
CX1	C	099	0038		GIS OS		
CX3	C	099	0038		IMS OS VI		
D11	C	099	0038		FASHION REPORT SYS		
D31	C	099	0038		COGS ALLOCATION DOS		
D32	C	099	0038		COGS FORECAST DOS		
D41	C	099	0038		OAS DOS		
D51	B	099	0028	AB	AGRI BUS MANG INFO	CH	
E11	B	099	0028	V	CRSWRTR III DOS		
F01	A	251	2999	AF	DOS FORT/7	27	
F12	C	099	0038		FIN TERM SYS		
F31	C	099	0038		BASE VER 2		
F32	C	099	0038		ACTIVE CIR INFO ACIP		
G21	C	099	0038		S/360 LEMRAS DOS		
G22	B	099	0028	V	FASTER LC	WA	
G24	C	099	0038		DOS FASTER MT		
G25	C	099	0038		BUDGET ACCT INFO SYS		
G26	C	099	0038		BASIC COURTS SYS		
H12	C	099	0038		SHARED LIB INFO SYS		
H15	B	099	0028	N	ECG ANALYSIS/DOS/VS	WP	
K12	C	099	0038		PAGINATION DOS		
LM-201	A	2**	2109	G	DOS F/ANS COBL LIB 3	02	COBOL
LM-461	A	2**	2119	AK	DOS PL/1 RES LIB	13	PL1
LM-561	A	2**	2129	AK	DOS PL/1 TRANS LIB	13	PL1
M11	C	099	0038		S/360 CAP PLN INF LD		

** - RECORD THE OPERATING SYSTEM OF PROGRAM PRODUCT:
 DD NOI USE 042 FOR DOS REGARDLESS OF THE RELEASE LEVEL
 OS & OTHER - 01, OS/VS1 - 52, SVS - 53, MVS - 55,
 VM/370 - 54, DOS - 02, DOS/VS - 56

PAGE OF : G229-2228-20
 REVISED : NOVEMBER 1977
 BY TNL : GN25-0005-4

PGM NO.	SVC CLS	FESN BASE	MAIL COMP	MAIL ADDR.	PROGRAM TITLE	SUPP CODE	FTSC GROUP
M12	C	099	0038		S/360 CAP PLN FIN LD		
M13	C	099	0038		S/360 REQ PLN INTRFC		
M31	C	099	0038		DOS/360 SHOP FL CNTR		
M41	B	099	0028	G	DOS/360 CAPOSS	ST	
M61	C	099	0038		PACIFIC-ESTIMATING		
M62	C	099	0038		PACIFIC-COST CONTROL		
M63	C	099	0038		PACIFIC-WORK MEASURE		
N11	C	099	0038		ALIS VER II DOS		
N13	B	099	0028	AB	CFO 11		CH
N14	B	099	0028	AB	ALPHA SEARCH		CH
N21	C	099	0038		PLIS DOS		
N22	C	099	0038		PALIS ADD FILE M1		
N24	C	099	0038		PALIS		
PL-161	A	2**	2169	AK	DOS PL/1 OPT COMP	13	PL1
P71	C	099	0038		ARRAY PROC SUBR M44		
P72	C	099	0038		ARRAY PROC SUBR OS		
RC-101	C	099	0039		DOS-ITF PL1		
RC-201	C	099	0039		DOS-ITF BASIC		
RC-300	A	2**	2399	E	DOS/VIDEO/370	62	VIDEO 370 DOS
RG-101	A	2**	1279	G	DOS RPG II	64	RPG
RG-1AR	A	2**	1279	G	AUTO REPORT	64	RPG
SM-101	C	099	0038		DOS TAPE/DISK S/M		
T11	B	099	0028	N	FARE QUOTE/TICKETING	WP	
T21	L	099	0038		TARIFF PUBLISH SYS		
T22	C	099	0038		TRAFFIC PROFILE ANAL		
UT1	C	099	0038		DOS BASIC UNFORM RD		
UT2	C	099	0038		ASCII II UTIL MAG TP		
UT4	B	099	0028	G	DOS/360 UDB	ST	-WT ONLY-
U12	C	099	0038		POWER SYS PLNG OS		
XC3	B	099	0028	BD	DOS S/7 APG	MF	
XC4	B	099	0028		DMS II DOS/VS		
XM3	C	099	0038		VEHICLE SCHED PROG		
XM-641	C	099	0039		APL DOS		
XM7	C	099	0038		S/360-S/370 SL MATH		
XP2	C	099	0038		REAL/360		
XS2	C	099	0038		DATA 360		
XS3	C	099	0038		GPSS V DOS		
XS4	C	099	0038		FAMS DOS		
XT2	B	099	0028		SPF/TSO		
XX2	C	099	0038		CATALIST		
XX3	C	099	0038		LEARN ATS-DOS		
XX4	C	099	0038		DATA BASE ORG & MAIN		
XX-600	A	2**	1629	CB	CICS/DOS-ENTRY	13	CICS-DOS
XX-700	A	2**	1639	CB	CICS/DOS-STANDARD	13	CICS-DOS
				BW	FERS	03	

5740-OS/VS PP

CB-103	A	2**	3779	AK	OS/VS COB COMPILER	13	COBOL
LM-103	A	2**	3779	AK	OS/VS COBOL LIB	13	CGBOL
11-214	A	2**	3841	AK	IMVS/VS FAST PATH	13	IMS
F11	B	099	0028		PC/3600		
F12	B	099	0028		TREND ANALYSIS/370		
M41	B	099	0028		CAPOSS-E		
M51	C	099	0038		370 APT-BP		
M52	B	099	0028		370 APT-IC	LA	
M53	B	099	0028		370 APT-AC	LA	
SM-105	A	2**	3539	S	OS/VS SORT/MERGE	65	SORT
UT-1	A	2**	3971	S	DASDR	65	
U11	B	099	0028		ENERGY MGMT SYSTEM		
XC2	B	099	0028		DMS/OS/VS		
XE2	B	099	0028	EM	MVS TSO 3270 EXTENDED02		

** - RECORD THE OPERATING SYSTEM OF PROGRAM PRODUCT:
 OS & OTHER - 01, OS/VS1 - 52, SVS - 53, MVS - 55,
 VM/370 - 54, DOS - 02, DOS/VS - 56

PGM NO.	SVC CLS	FESN BASE	MAIL COMP	MAIL ADDR.	PROGRAM TITLE	SUPP CODE	FTSC GROUP
XM1	C	099	0038		GRAPHAGE OS/V5		
XM3	B	099	0028	AR	MPSX/370 OS/V5	PR	
XN2	C	099	0038		MDAP		
XP1	B	099	0028	AR	PROJACS OS/V5	PR	
XR1	B	099	0028	G	STAIRS/V5	ST	
XR2	C	099	0038		RIRMS OS/V5		
XR3	C	099	0038		TGS/7		
XR4	B	099	0028	AR	DECTAT OS/V5	PR	
XR-500	A	252	3871	AK	OS/V51 VSPC		13 VSPC
XR-600	A	255	3881	AK	OS/V52 VSPC		13 VSPC
XR-800	A	255	4121	AK	JES 2 NJE		13 JES 2
XR9	B	099	0028		VS TS10		
XT1	C	099	0038		PSG/TS0		
XT2	B	099	0028		3270 SPF		
XT3	B	099	0028		PSG II/OS/V5		
XT4	B	099	0028		TPNS		
XT5	B	099	0028		PSG II/V5-T50		
XT6	A	255	3961	BN	TSO CMD PKG	02	TSO
XT7	B	099	0028		OPC ENTRY		
XT8	B	099	0028		TSO 3270 SPF		
XXA	C	099	0038		DB/DC DRIVER SYSTEM		
XXB	B	099	0028	AR	STEPS-PROD OS/V5	PR	
XXC	A	2**	3821	CN	TCAM IMS		13 IMS
XX-D00	A	2**	3831	CK	TCS-AF		23 TCS
XXF	B	099	0028		DB/DC DATA DICTIONARY		
XX-H00	A	255	3911	BN	RACF	02	RACF
XX-M00	A	255	3591	CG	RMF	02	RMF
XXT	B	099	0028		DB/DC DRIVER SYS		
XXV	B	099	0028		ATMS-II/OS/V5		
XX-100	A	2**	3509	CB	CICS/OS/V5		13 CICS
XX-210	A			AK	IMS/V5 V1 M0 (SEE NOTE 1)		
	A	2**	3519		DATA BASE		13 IMS
	A	2**	3518		DATA COMM		13 IMS
	A	2**	3517		SYSTEM		13 IMS
	A	2**	3516		UTILITIES		13 SEE NOTE 2
	C	099	0028		IQF		
XX-211	A			AK	IMS/V5 V1 M1 (SEE NOTE 1)		
	A	2**	3519		DATA BASE		13 IMS
	A	2**	3518		DATA COMM		13 IMS
	A	2**	3517		SYSTEM		13 IMS
	A	2**	3516		UTILITIES		13 SEE NOTE 2
	C	099	0028		IQF		
XX-214	A			AK	IMS/V5 V1 M4 (SEE NOTE 1)		
	A	2**	3519		DATA BASE		13 IMS
	A	2**	3518		DATA COMM		13 IMS
	A	2**	3517		SYSTEM		13 IMS
	A	2**	3516		UTILITIES		13 SEE NOTE 2
	C	099	0028		IQF		
XX-3	B	099	0028		ATMS/OS		
XX-700	A	2**	3669	AK	GIS/V5		13 IMS
XX-8	B	099	0028	AR	PLANCODE I OS VS	PR	
XX-9	B	099	0028	AR	PLANCODE S OS VS	PR	
XY-211	A	2**	3842		MSC		13 IMS

NOTE 1: CROSS-REFERENCE MODULE BY SERVICE NUMBER USING
 IMS/V5 SERVICE NUMBER REFERENCE SUMMARY SY25-7722.
 NOTE 2: SEE DB OR DC MICROFICHE AS NECESSARY.

** - RECORD THE OPERATING SYSTEM OF PROGRAM PRODUCT:
 DO NOT USE 042 FOR DOS REGARDLESS OF THE RELEASE LEVEL
 OS & OTHER - 01, OS/V51 - 52, SVS - 53, MVS - 55,
 VM/370 - 54, DOS - 02, ODS/V5 - 56

PAGE OF : G229-2228-20
 REVISED : NOVEMBER 1977
 BY TNL : GN25-0005-4

PGM NO.	SVC CLS	FESN BASE	MAIL COMP ADDR.	PROGRAM TITLE	SUPP CODE	FTSC GROUP

5741- OS/VS1 RELEASE 050,060						

SC1-BB	SCP	152 1002	AN	RES/RTAM	02	JOB MGMT
SC1-BC	SCP	152 1003	BN	RES ACCOUNT UTILITY	02	JOB MGMT
SC1-BD	SCP	152 1004	AN	RSTRT RDR/DSOR PROC	02	JOB MGMT
SC1-BE	SCP	152 1005	AN	SYSTEM LOG	02	JOB MGMT
SC1-BF	SCP	152 1006	AN	WTP	02	JOB MGMT
SC1-BG	SCP	152 1007	AN	SCHED INITIALIZATION	02	JOB MGMT
SC1-BJ	SCP	152 1011	AN	JOB LIST MGR	02	JOB MGMT
SC1-BK	SCP	152 1012	AN	ISSP	02	JOB MGMT
SC1-BZ	SCP	152 1026	O	MSS RECOVERY SERV	13	JOB MGMT
SC1-B0	SCP	152 1030	AN	JEC5	02	JOB MGMT
SC1-B1	SCP	152 1031	AN	INPUT STREAM CONTROL	02	JOB MGMT
SC1-B2	SCP	152 1032	AN	OUTPUT STREAM CTL	02	JOB MGMT
SC1-B3	SCP	152 1033	AN	SYSTEM RESTART	02	JOB MGMT
SC1-B4	SCP	152 1034	AN	I O DEVICE ALLOC	02	JOB MGMT
SC1-B5	SCP	152 1035	AN	QUEUE MANAGER	02	JOB MGMT
SC1-B6	SCP	152 1036	AN	INITIATOR/DSO	02	JOB MGMT
SC1-B7	SCP	152 1037	AN	TERMINATION	02	JOB MGMT
SC1-B8	SCP	152 1038	AN	COMMANDS	02	JOB MGMT
SC1-B9	SCP	152 1039	AN	INTERPRETER	02	JOB MGMT
SC1-CA	SCP	152 1101	AK	OASD ERP	13	ERP
SC1-CB	SCP	152 1102	AK	UNIT RECORD ERP	13	ERP
SC1-CC	SCP	152 1103	AK	TAPE ERP/VES	13	ERP
SC1-CD	SCP	152 1104	BG	OBR/EREP/RDE	02	ERP
SC1-CE	SCP	152 1105	BG	RMS	02	SUPERVISOR
SC1-CI	SCP	152 1109	O	3851 ERP	13	ERP
SC1-CN	SCP	152 1115	AN	COMMON SUPV MACROS	02	SUPERVISOR
SC1-CP	SCP	152 1117	AN	EXT PREC FLT PT SIM	02	SUPERVISOR
SC1-CS	SCP	152 1122	AK	CONDITIONAL ASM SWTH	13	SUPERVISOR
SC1-C1	SCP	152 1131	AN	IPL	02	SUPERVISOR
SC1-C2	SCP	152 1132	AK	OVERLAY SUPERVISOR	13	SUPERVISOR
SC1-C3	SCP	152 1133	AN	IOS	02	IOS
SC1-C4	SCP	152 1134	BG	DIDDCS	02	DIDDCS
SC1-C5	SCP	152 1135	AN	SUPERVISOR	02	SUPERVISOR
SC1-C7	SCP	152 1137	AK	FETCH	13	SUPERVISOR
SC1-C8	SCP	152 1138	AN	NIP	02	SUPERVISOR
SC1-DB	SCP	152 1202	AK	JES COMPAT INTERFACE	13	DATA MGMT
SC1-DC	SCP	152 1203	AK	PASSWORD PROTECT	13	DATA MGMT
SC1-DD	SCP	152 1204	AK	3505/3525 RDR/PCH SP	13	DATA MGMT
SC1-DE	SCP	152 1205	AK	VSAM	13	DATA MGMT
SC1-DF	SCP	152 1206	AN	3890 DOC PROC	02	DATA MGMT
SC1-DK	SCP	152 1212	AK	IDCAMS	13	DATA MGMT
SC1-DL	SCP	152 1213	AN	3886 OCR	02	DATA MGMT
SC1-DN	SCP	152 1216	AN	3540	02	DATA MGMT
SC1-DP	SCP	152 1217	O	MSS COMMUNICATOR	13	DATA MGMT
SC1-DQ	SCP	152 1218	O	MSC TABLE CREATE	13	DATA MGMT
SC1-DR	SCP	152 1219	O	MSS SPACE MANGE	13	DATA MGMT
SC1-DS	SCP	152 1222	O	MSS DATA ANALYSIS	13	DATA MGMT
SC1-DT	SCP	152 1223	O	MSC TRACE	13	DATA MGMT
SC1-DU	SCP	152 1224	O	MSS SERVICES	13	DATA MGMT
SC1-D0	SCP	152 1230	AK	SAM	13	DATA MGMT
SC1-D1	SCP	152 1231	AK	OPEN/CLOSE/EOV	13	DATA MGMT
SC1-D2	SCP	152 1232	AK	PAM	13	DATA MGMT
SC1-D3	SCP	152 1233	AK	CATALOG	13	DATA MGMT
SC1-D4	SCP	152 1234	AK	DADSM	13	DATA MGMT
SC1-D5	SCP	152 1235	AN	OCR	02	DATA MGMT
SC1-D6	SCP	152 1236	AK	MICR	13	DATA MGMT
SC1-D7	SCP	152 1237	AK	DAM	13	DATA MGMT
SC1-D8	SCP	152 1238	AK	ISAM	13	DATA MGMT
SC1-D9	SCP	152 1239	AK	JAM	13	DATA MGMT
SC1-E1	SCP	152 1241	F	EMUL CONTROL	63	EMULATOR
SC1-G0	SCP	152 1640	CF	GAM	02	BTAM
SC1-I0	SCP	152 1540	S	IBCDMPRS	65	UTILITY
SC1-I1	SCP	152 1541	S	IBCDASDI	65	UTILITY

PGM NO.	SVC CLS	FESN BASE	COMP	MAIL ADDR.	PROGRAM TITLE	SUPP CODE	FTSC GROUP
SC1-12	SCP	152	1542	S	ICAPRTBL	65	UTILITY
SC1-SS	SCP	152	1322	BX	SSS (BASE IND) INTG	03	INDUSTRY SYS
		152	1322	BX	SSS (BASE IND) ICR	03	INDUSTRY SYS
SC1-S1	SCP	152	1331	AN	SYSGEN	02	SYSGEN
SC1-S2	SCP	152	1332	AN	STARTER SYSTEM 3330	02	SYSGEN
SC1-S3	SCP	152	1333	AN	STARTER SYSTEM 2314	02	SYSGEN
SC1-S4	SCP	152	1334	AN	SUPERVISOR SYSGEN	02	SYSGEN
SC1-S5	SCP	152	1335	AN	SCHEDULER SYSGEN	02	SYSGEN
SC1-S6	SCP	152	1336	BG	SERVICE AIDS SYSGEN	02	SYSGEN
SC1-UA	SCP	152	1501	S	IEBPTPCH	65	UTILITY
SC1-UC	SCP	152	1503	S	IEHMOVE	65	UTILITY
SC1-UD	SCP	152	1504	S	IEHINITT	65	UTILITY
SC1-UE	SCP	152	1505	S	IEHSTATR	65	UTILITY
SC1-UF	SCP	152	1506	S	IEHATLAS	65	UTILITY
SC1-UG	SCP	152	1507	AN	IEBTCRIN	02	UTILITY
SC1-UH	SCP	152	1508	S	IEBISAM	65	UTILITY
SC1-UJ	SCP	152	1511	S	IEBDG	65	UTILITY
SC1-UK	SCP	152	1512	S	IEBCOMPR	65	UTILITY
SC1-UM	SCP	152	1514	S	IEBIMAGE	65	UTILITY
SC1-UX	SCP	152	1527	S	SGIEH402	65	UTILITY
SC1-U0	SCP	152	1530	S	IEHDASDR	65	UTILITY
SC1-U1	SCP	152	1531	S	IEHIDOSUP	65	UTILITY
SC1-U2	SCP	152	1532	S	IEHLIST	65	UTILITY
SC1-U3	SCP	152	1533	S	IEHPRGM	65	UTILITY
SC1-U6	SCP	152	1536	S	IEBCOPY	65	UTILITY
SC1-U7	SCP	152	1537	S	IEBGENER	65	UTILITY
SC1-U8	SCP	152	1538	S	IEBUPDTE	65	UTILITY
SC1-U9	SCP	152	1539	S	IEBEDIT	65	UTILITY
SC1-0A	SCP	152	1601	AK	CRJE	02	CRJE
SC1-0B	SCP	152	1602	AN	REL LEVEL ID MACROS	02	SUPRV MACRO
SC1-0C	SCP	152	1603	BX	TOLTEP	02	VTAM
SC1-0E	SCP	152	1605	CF	POWER WARNING FEAT	02	SUPERVISOR
SC1-00	SCP	152	1630	AN	SCHEDULER SMF	02	JOB MGMT
SC1-01	SCP	152	1631	BN	MAPPING MACROS	02	SUPRV MACRO
SC1-02	SCP	152	1632	AN	SMF	02	JOB MGMT
SC1-03	SCP	152	1633	S	ASSEMBLER XF	65	ASSEMBLER
SC1-04	SCP	152	1634	AK	LINKAGE EDITOR	13	LINK EDIT
SC1-05	SCP	152	1635	AK	LOADER	13	LINK EDIT
SC1-06	SCP	152	1636	BG	DLTEP	02	DLTEP
SC1-07	SCP	152	1637	CF	GSP	02	SUPERVISOR
SC1-08	SCP	152	1638	AN	IVP	02	SYSGEN
SC1-09	SCP	152	1639	AK	CHECK POINT/RESTART	13	JOB MGMT
SC1-10	C	099	0039		DSS	02	
SC1-11	SCP	152	1731	BG	GTF	02	SERVICE AID
SC1-12	SCP	152	1732	BG	HMASPZAP	02	SERVICE AID
SC1-13	SCP	152	1733	BG	HMDPRDMP	02	SERVICE AID
SC1-14	SCP	152	1734	AK	HMBLIST	13	SERVICE AID
SC1-15	SCP	152	1735	BG	HMDSADMP	02	SERVICE AID
SC1-16	SCP	152	1736	BG	HMAPTFLE	02	SERVICE AID
SC1-17	SCP	152	1737	AN	IMCJOBQD	02	SERVICE AID
SC1-18	SCP	152	1738	BG	HMDPRDMP/EDIT	02	SERVICE AID
SC1-19	SCP	152	1739	AN	IMCOSJQD	02	SERVICE AID
SC1-20	SCP	152	1830	CE	BTAM	02	BTAM
SC1-21	SCP	152	1831	AL	TCAM (LEVELS 8 & 9)	23	TCAM
		152	1832	AL	TCAM DIRECT(LEVEL 10)	23	TCAM
SC1-23	SCP	152	1833	BX	VTAM	02	VTAM
SC1-24	SCP	152	4012	CM	3600 HOST SUPPORT	02	INDUSTRY SYS
*SC1-26	SCP	152	3183	BU	CTS-RETAIL HOST	23	INDUSTRY SYS
*SC1-27	SCP	152	3192	BU	CTS-SUPERMARKET HOST	23	INDUSTRY SYS
*SC1-28	SCP	152	3182	AL	CTS-SPPS	23	INDUSTRY SYS
SC1-29	SCP	152	1839	BX	SPS/KE	02	INDUSTRY SYS
SC1-30	SCP	152	1740	CF	HMASMP	02	SMP
SC1-31	SCP	152	1841	AK	3344/3350 AP-1	13	SUPERVISOR

PAGE OF : G229-2228-20
 REVISED : NOVEMBER 1977
 BY TNL : GN25-0005-4

PGM NO.	SVC CLS	FESN BASE	MAIL COMP	PROGRAM ADDR.	TITLE	SUPP CODE	FTSC GROUP

5742 - OS/VS2 RELEASE 017							

SC1-BZ	SCP	153	1026	O	MSS REC SERVICE	13	
SC1-B2	SCP	153	0142	AK	SYSOUT WRITER	13	JOB MGMT
SC1-B3	SCP	153	0143	AX	SYSTEM RESTART	02	JOB MGMT
SC1-B4	SCP	153	0144	AX	ALLOCATION	02	JOB MGMT
SC1-B5	SCP	153	0145	AX	QUEUE MANAGER	02	JOB MGMT
SC1-B6	SCP	153	0146	AX	INITIATOR	02	JOB MGMT
SC1-B7	SCP	153	0240	AX	TERMINATION	02	JOB MGMT
SC1-B8	SCP	153	0147	AX	COMMANDS	02	JOB MGMT
SC1-B9	SCP	153	0148	AX	INTERPRETER	02	JOB MGMT
SC1-CA	SCP	153	0165	AK	DASD ERP	13	ERP
SC1-CB	SCP	153	0166	AK	UNIT RECORD ERP	13	ERP
SC1-CC	SCP	153	0167	AK	TAPE ERP/VES	13	ERP
SC1-CD	SCP	153	0168	BG	OBR/EREP/RDE	02	ERP
SC1-CE	SCP	153	0169	BG	RMS	02	SUPERVISOR
SC1-CF	SCP	153	0135	BG	EXTENDED SERVICE RTR	02	SUPERVISOR
SC1-CI	SCP	153	1109	O	MSS 3851 ERP	13	ERP
SC1-CN	SCP	153	0241	BG	COMMON SUPV MACROS	02	SUPERVISOR
SC1-CP	SCP	153	0242	AN	EXT PREC FLT PT SIM	02	SUPERVISOR
SC1-CS	SCP	153	0119	AK	CONDITIONAL ASH SWTH	13	SUPERVISOR
SC1-CT	SCP	153	0243	BN	BLDL LIST	02	SUPERVISOR
SC1-C1	SCP	153	0131	BG	IPL	02	SUPERVISOR
SC1-C2	SCP	153	0132	AK	OVERLAY SUPERVISOR	13	SUPERVISOR
SC1-C3	SCP	153	0133	AK	IOS	13	IOS
SC1-C4	SCP	153	0134	BG	DIDDCS	02	DIDDCS
SC1-C5	SCP	153	0244	BG	SUPERVISOR	02	SUPERVISOR
SC1-C7	SCP	153	0137	AK	FETCH	13	SUPERVISOR
SC1-DC	SCP	153	0154	AK	PASSWORD PROTECT	13	DATA MGMT
SC1-DD	SCP	153	0158	AK	3505/3525 RDR/PCH SP	02	DATA MGMT
SC1-DE	SCP	153	0157	AK	VSAM	13	DATA MGMT
SC1-DK	SCP	153	0159	AK	IDCAMS	13	DATA MGMT
SC1-DP	SCP	153	1217	O	MSS COMMUNICATOR	13	DATA MGMT
SC1-DQ	SCP	153	1218	O	MSS TABLE CREATE	13	DATA MGMT
SC1-DR	SCP	153	1219	O	MSS SPACE MGT	13	DATA MGMT
SC1-DS	SCP	153	1222	O	MSS DATA ANALYSIS	13	DATA MGMT
SC1-OT	SCP	153	1223	O	MSS TRACE	13	DATA MGMT
SC1-OU	SCP	153	1224	O	MSS SERVICES	13	DATA MGMT
SC1-D0	SCP	153	0153	AK	SAM	13	DATA MGMT
SC1-D1	SCP	153	0152	AK	OPEN/CLOSE/EDV	13	DATA MGMT
SC1-D2	SCP	153	0246	AK	PAM	13	DATA MGMT
SC1-D3	SCP	153	0245	AK	CATALOG	13	DATA MGMT
SC1-D4	SCP	153	0247	AK	DADSM	13	DATA MGMT
SC1-D5	SCP	153	0248	AN	OCR	02	DATA MGMT
SC1-D6	SCP	153	0249	AK	MICR	13	DATA MGMT
SC1-D7	SCP	153	0250	AK	DAM	13	DATA MGMT
SC1-D8	SCP	153	0151	AK	ISAM	13	DATA MGMT
SC1-G0	SCP	153	0155	CF	GAM	02	BTAM
SC1-I0	SCP	153	0123	S	IBCDMPRS	65	UTILITY
SC1-I1	SCP	153	0251	S	IBCDASDI	65	UTILITY
SC1-I2	SCP	153	0252	S	ICAPRTBL	65	UTILITY
SC1-S5	SCP	153	1322	BX	SSS (BASE IND SUPT)	03	INDUSTRY SYS
SC1-S1	SCP	153	0117	AK	SYSGEN	13	SYSGEN
SC1-S2	SCP	153	0112	AK	STARTER SYSTEM 3330	13	SYSGEN
SC1-S3	SCP	153	0111	AK	STARTER SYSTEM 2314	13	SYSGEN
SC1-S4	SCP	153	0253	AK	SUPERVISOR SYSGEN	02	SYSGEN
SC1-S5	SCP	153	0254	AX	SCHEDULER SYSGEN	02	SYSGEN
SC1-S6	SCP	153	0255	BG	SERVICE AIDS SYSGEN	02	SYSGEN
SC1-T0	SCP	153	0181	AX	TSO EDIT	02	TSO
SC1-T1	SCP	153	0182	AX	TSO TEST	02	TSO
SC1-T2	SCP	153	0256	AX	TSO UTILITIES	23	TSO
SC1-T3	SCP	153	0183	AX	TSO DATA MANAGEMENT	23	TSO
SC1-T4	SCP	153	0184	AX	TSO SCHEDULER	02	TSO

PGM NO.	SVC CLS	FESN BASE	MAIL ADDR.	PROGRAM TITLE	SUPP CODE	FTSC GROUP
SC1-T5	SCP	153 0185	AK	LINK LOADGO PROMPTER	13	TSO
SC1-T7	SCP	153 0187	AX	TSO SUPERVISOR	02	TSO
SC1-T8	SCP	153 0188	AL	TSO TCAM SUBROUTINE	23	TSO TCAM
SC1-T9	SCP	153 0189	AX	TSO TRACE	02	TSO
SC1-UA	SCP	153 0122	S	IEBPDPCH	65	UTILITY
SC1-UC	SCP	153 0121	S	IEHMOVE	65	UTILITY
SC1-UD	SCP	153 0257	S	IEHINIT	65	UTILITY
SC1-UE	SCP	153 0258	S	IEHSTATR	65	UTILITY
SC1-UF	SCP	153 0259	S	IEHATLAS	65	UTILITY
SC1-UG	SCP	153 0260	AN	IEBTGRIN	02	UTILITY
SC1-UH	SCP	153 0261	S	IEBISAM	65	UTILITY
SC1-UJ	SCP	153 0262	S	IEBDG	65	UTILITY
SC1-UK	SCP	153 0263	S	IEBCOMPR	65	UTILITY
SC1-UM	SCP	153 1514	S	IEBIMAGE	65	UTILITY
SC1-UX	SCP	153 0116	S	SGIEH402	65	UTILITY
SC1-UO	SCP	153 0264	S	IEHDASDR	65	UTILITY
SC1-U2	SCP	153 0265	S	IEHLIST	65	UTILITY
SC1-U3	SCP	153 0266	S	IEHPRGM	65	UTILITY
SC1-U6	SCP	153 0267	S	IEBCOPY	65	UTILITY
SC1-U7	SCP	153 0268	S	IEBGENER	65	UTILITY
SC1-U8	SCP	153 0269	S	IEBUPDTE	65	UTILITY
SC1-U9	SCP	153 0270	S	IEBEDIT	65	UTILITY
SC1-0B	SCP	153 0271	BN	REL LEVEL ID MACROS	02	SUPRV MACRO
SC1-0C	SCP	153 1603	BX	TOLTEP	02	VTAM
SC1-0E	SCP	153 0150	CF	POWER WARNING FEAT	02	SUPERVISOR
SC1-00	SCP	153 0138	AX	SCHEDULER SMF	02	JOB MGMT
SC1-01	SCP	153 0272	BN	MAPPING MACROS	02	SUPRV MACRO
SC1-02	SCP	153 0273	AX	SMF	02	JOB MGMT
SC1-03	SCP	153 0113	S	ASSEMBLER XF	65	ASSEMBLER
SC1-04	SCP	153 0114	AK	LINKAGE EDITOR	13	LINK EDIT
SC1-05	SCP	153 0115	AK	LOADER	13	LINK EDIT
SC1-06	SCP	153 0161	BG	DLTEP	02	DLTEP
SC1-07	SCP	153 0156	CF	GSP	02	SUPERVISOR
SC1-08	SCP	153 0118	BR	IYP	02	SYSGEN
SC1-09	SCP	153 0136	AK	CHECK POINT/RESTART	13	JOB MGMT
SC1-10	C	099 0039		DSS	02	
SC1-11	SCP	153 0163	BG	GTF	02	SERVICE AID
SC1-12	SCP	153 0164	BG	AMASPZAP	02	SERVICE AID
SC1-13	SCP	153 0274	BG	ANDPRDMP	02	SERVICE AID
SC1-14	SCP	153 0275	AK	AMBLIST	13	SERVICE AID
SC1-15	SCP	153 0276	BG	AMDSADMP	02	SERVICE AID
SC1-16	SCP	153 0277	BG	AMAPTFILE	02	SERVICE AID
SC1-18	SCP	153 0278	BG	ANDPRDMP/EDIT	02	SERVICE AID
SC1-20	SCP	153 0176	CE	BTAM	02	BTAM
SC1-21	SCP	153 1831	AL	TCAM (LEVEL 5)	23	TCAM
		153 1832	AL	TCAM DIRECT(LEVEL 10)	23	TCAM
SC1-22	SCP	153 0172	BG	3735 MACROS/UTILITY	23	BTAM
SC1-23	SCP	153 1833	BX	VTAM	03	VTAM
SC1-30	SCP	153 0230	CF	HMASNP	02	SMP
SC1-31	SCP	153 1841	AK	3344/3350 AP-1	13	SUPERVISOR

5743						

SM-103	C	099 0038		DOS SORT/MERGE 3330		

PAGE OF : G229-2228-20
 REVISED : NOVEMBER 1977
 BY TNL : GN25-0005-4,

PGM NO.	SVC CLS	FESN BASE	MAIL COMP	MAIL ADDR.	PROGRAM TITLE	SUPP CODE	FTSC GROUP

5744							

AA1	SCP	151	0809	AF	OS/V5 MACLIB/R		27
AB1	SCP	151	0819	AF	OS/V5 ASM/7		27
AC1	SCP	151	0829	AF	OS/V5 LINK/7		27
AD1	SCP	151	0839	AF	OS/V5 FORMAT/7		27

*THE FOLLOWING 5744 PID NUMBERS ARE FOR OS/V5 *							

AE1	SCP	152	2051		1285/1287/1288 DM		DATA MGMT
AG1	SCP	1**	2071	F	1410 EMULATOR	63	EMULATOR
AH1	SCP	1**	2081	F	1401 EMULATOR	63	EMULATOR
AJ1	C	099	0038		155,158/7074 EMUL		
AK1	C	099	0038		165,168/7074 EMUL		
AL1	C	099	0038		165,168/7080 EMUL		
AM1	C	099	0038		165,168/7094 EMUL		
AN1	SCP	1**	2151	AL	3705 SSP FOR OS/V5	23	3705 PROG
AS1	SCP	1**	2221	F	005 EMULATOR	63	EMULATOR
AZ1	SCP	152	2291	BG	3735 MACROS & UTIL	23	BTAM
BJ1	C	099	0038		OS/V51 DISK COPY PROG		
BK1	SCP	152	3121	CF	DIST INTEL SYS	02	INDUSTRY SYS
BL1	C	099	0038		OS/V52 DISK COPY PROG		
BQ2	SCP	1**	3182	AL	CTS SPPS	23	INDUSTRY SYS
BQ3	SCP	152	3183	BU	CTS RETAIL HOST	23	INDUSTRY SYS
BQ4	SCP	155	3183	BU	CTS RETAIL HOST	23	INDUSTRY SYS
BR2	SCP	1**	3192	BU	CTS SUPERMARKET HOST	23	INDUSTRY SYS
BZ1	SCP	152	3291	BT	3790 HOST SUPPORT	02	INDUSTRY SYS
BZ2	SCP	155	3291	BT	3790 HOST SUPPORT	02	INDUSTRY SYS
BZ3	SCP	1**	3291	BT	3790 HOST SUPPORT	02	INDUSTRY SYS
CA3	SCP	1**	4012	CM	3600 HOST SUPPORT	02	INDUSTRY SYS
CG1	SCP	152	4071	H	BATCH TRANSFER PROG	03	INDUSTRY SYS
CG2	SCP	155	4072	H	BATCH TRANSFER PROG	03	INDUSTRY SYS
CH1	SCP	153	4073	H	BATCH TRANSFER PROG	03	INDUSTRY SYS

** - RECORD THE OPERATING SYSTEM OF THE COMPONENT :
 OS/V51 - 52, SVS - 53, MVS - 55.

PGM NO.	SVC CLS	FESN BASE	MAIL COMP	ADDR.	PROGRAM TITLE	SUPP CODE	FTSC GROUP

```

*****
*5745-DOS/V5 RELEASE 320, 330, 340, 701 *
*****
* FOR SCP RECORD BASE OF 156. *
* DOS/V5 ADVANCED FUNCTION IS A PROGRAM PRODUCT. *
* FOR ADVANCED FUNCTION COMPONENTS RECORD BASE 256. *
* RECORD LEVEL 701 IN THE RELEASE BLOCK OF THE PSAR *
* AND COMPONENT LEVEL BLOCK OF THE APAR WHEN WORKING *
* ON ADVANCED FUNCTION COMPONENTS. *
* USE THE BASE SCP COMPONENT ID'S WHEN SUBMITTING *
* APARS. DO NOT SUBMIT APAR AGAINST 5746 COMPONENT ID*
*****
SC-AIT SCP *** 0132 H ATTENTION ROUTINES 02 SUPERVISOR
SC-AMS SCP 156 0122 AK VSAM SERVICE PROG 13 LIOCS
SC-APC SCP 156 1841 AK 3344/3350 AP-1 13 SUPERVISOR
SC-ASM SCP 156 0137 S ASSEMBLER PHK 02 ASSEMBLER
SC-BTM SCP 156 0171 CE BTAM 23 BTAM
SC-CKR SCP 156 0133 H CHECKPOINT/RESTART 02 SUPERVISOR
SC-DAM SCP 156 0152 H DIR ACC METHOD 02 LIOCS
SC-DIO SCP 156 0153 AN DISKETTE IOCS 02 LIOCS
SC-DIS SCP 156 0123 H DISTRIBUTION PROGRAM 02 SUPERVISOR
SC-DKE SCP 156 0166 H DISK ERP 02 SUPERVISOR
SC-DOC SCP *** 0138 H DISP OPER CONSOLE 02 SUPERVISOR
SC-DSK SCP 156 0153 H SEQUENT DISK I/O 02 LIOCS
*SC-EML SCP 156 0181 F 1401/1410 EMULATOR 02 EMULATOR
SC-ERP SCP 156 0165 H EREP 02 SUPERVISOR
SC-E20 SCP 156 0182 F MOD 20 EMULATOR 02 EMULATOR
SC-IDM SCP 156 0154 H COMP I/O MODULES 02 LIOCS
SC-IDX SCP 156 0155 H IOCS/DEV IND I/O 02 LIOCS
SC-IPL SCP *** 0134 H IPL BUFFER LOAD 02 SUPERVISOR
SC-ISM SCP 156 0156 H INDEX SEQ FILE MGMT 02 LIOCS
SC-JCL SCP *** 0141 H JOB CONTROL 02 JOB CONTROL
SC-LBR SCP *** 0135 H LIB, SERV AND MAINT 02 SUPERVISOR
156 0135 G COPYSERV (R330 ONLY) 02 SUPERVISOR
SC-LNK SCP *** 0136 H LINKAGE EDITOR 02 JOB CONTROL
SC-MCR SCP 156 0157 H MCR IOCS 02 LIOCS
SC-OCR SCP 156 0158 AN OCR IOCS 02 LIOCS
SC-OLT SCP 156 0161 BG OLTEP 02 SUPERVISOR
SC-PDA SCP *** 0163 H PD AIDS 02 SERVICE AID
SC-PTP SCP 156 0154 H PAPER TAPE IOCS 02 LIOCS
SC-PWR SCP 156 0143 H POWER/V5 02 POWER
SC-QTM SCP 156 0172 CE QTAM 23 QTAM
SC-RMS SCP 156 0164 H RMSR 02 SUPERVISOR
*SC-RTL SCP 156 3183 BU CTS RETAIL HOST 23 INDUSTRY SYS
*SC-SMK SCP 156 3192 BU CTS SUPERMARKET HOST 23 INDUSTRY SYS
*SC-SPP SCP 156 3182 AL CTS-SPPS 23 INDUSTRY SYS
*SC-SSS SCP 156 0190 BX SSS (BASE IND SUPT) 02 INDUSTRY SYS
SC-SUP SCP *** 0131 H SUPERVISOR 02 SUPERVISOR
SC-TAP SCP 156 0159 H MAG TAPE IOCS 02 LIOCS
SC-TLT SCP 156 0162 BX TOLTEP 02 VTAM
SC-TPE SCP 156 0167 H TAPE ERP 02 SUPERVISOR
SC-UTL SCP 156 0121 H SYSTEM UTILITIES 02 UTILITY
156 0121 G BACKUP (IJWSABK) 02 UTILITY
156 0121 G RESTORE (IJWSARST) 02 UTILITY
156 0121 H OBJMAINT 02 UTILITY
SC-UTS SCP 156 0124 G MAINTAIN SYS HIST 02 SUPERVISOR
SC-VSM SCP 156 0151 G VSAM 13 LIOCS
SC-VTM SCP 156 0173 BX VTAM 02 VTAM
SC-124 SCP 156 1181 CM 3600 HOST SUPPORT 02 INDUSTRY SYS

```

*** INDICATES COMPONENTS AFFECTED BY ADVANCED FUNCTION.
 * INDEPENDENT RELEASE - NOT INTEGRATED WITH BASE SYSTEM.

PAGE DF : G229-2228-20
 REVISED : NOVEMBER 1977
 BY TNL : GN25-0005-4

PGM NO.	SVC CLS	FESN I	MAIL BASE	PROGRAM TITLE	SUPP CODE	FTSC GROUP

5746-DOS/VS PP						

CB-100	A	256 3569	G	DOS/VS FULL CBL/LIB	64	COBOL DOS

* THESE ARE THE COMPONENTS OF DOS/VS ADVANCED FUNCTION *						
*E2-AIT	A	256 0132	*	ATTENTION ROUTINES	02	SUPERVISOR
*E2-DOC	A	256 0138	*	DISP OPER CONSOLE	02	SUPERVISOR
*E2-IPL	A	256 0134	*	IPL BUFFER LOAD	02	SUPERVISOR
*E2-JCL	A	256 0141	*	JOB CONTROL	02	JOB CONTROL
*E2-LBR	A	256 0135	*	LIB,SERV AND MAINT	02	SUPERVISOR
*E2-LNK	A	256 0136	*	LINKAGE EDITOR	02	JOB CONTROL
*E2-PDA	A	256 0163	*	PD AIDS	02	SERVICE AID
*E2-SUP	A	256 0131	*	SUPERVISOR	02	SUPERVISOR
* FOR APAR REPORTING USE THE CORRESPONDING 5745 COMPO- *						
* NENT ID AND MAILING ADDRESS. RECORD LEVEL 701 IN THE *						
* RELEASE BLOCK OF THE PSAR AND THE COMPONENT LEVEL *						
* BLOCK OF THE APAR FORM. *						
* DO NOT APAR THE 5746 COMPONENTS--USE THE *						
* CORRESPONDING 5745 COMPONENTS FOR APAR PURPOSES *						

F11	B	099 0029		PROG CUSTOMIZER		
F12	B	099 0029		DOSCHECK		
F31	C	099 0039		BASE VER 3		
F51	C	099 0038		BUOPLAN DOS/VS		
H12	C	099 0038		HCS/LIS		
H13	C	099 0038		HCS/DATA COMM		
H14	B	099 0028	N	HCS/ACCTG SYS		WP
LM-302	A	256 3439	AK	FORT 4 LIB DOS 3330	13	FORTRAM
LM-400	A	256 3569	G	DOS/VS FULL LIB	02	COBOL
M41	B	099 0028		CAPOSS-E		
N11	B	099 0029		LIFE INQ/DATA ENTRY		
RG-100	A	256 1278	G	RPG II COMPILER	64	RPG
SM-104	A	256 3529	S	DOS/VS SORT/MERGE	65	SORT DOS
SM-200	A	256 3528	S	DOS/VS SORT/MERGE	65	SORT DOS
XC2	B	099 0028		DMS/DOS/VS		
XM1	C	099 0038		GRAPHAGE DOS/VS		
XM2	B	099 0028	AR	MPSX/370 DOS/VS		PR
XN1	B	099 0028	AR	APT-BC DOS/VS		PR
XN2	C	099 0038		DOS/VS MDAF		
XP1	B	099 0028	AR	PROJACS DOS/VS		PR
XR1	C	099 0038		RIRMS DOS/VS		
XR2	B	099 0028	AR	DECTAT DOS/VS		PR
XR-300	A	256 3891	AK	DOS/VS VSPC	13	VSPC
XR4	B	099 0028		STAIRS/DOS/VS		
XT1	B	099 0028		PSG II/DOS/VS		
XXA	B	099 0028	AR	PLANCODE S DOS VS		PR
XX-800	A	256 3498	CI	CICS DOS VS EXTM	13	CICS
XXC	B	099 0028		DB/DC DATA DICTIONARY		
XXG	B	099 0028		ATMS-II/DOS/VS		
XX-100	A	256 3469	G	DL/I DOS	13	DLI
XX2	B	099 0029	AR	STEPS PROD DOS/VS		PR
XX-300	A	256 3499	CB	CICS/DOS/VS	13	CICS DOS
XX-400	B	099 0029		ATMS/DOS/VS		
XX-700	A	256 3689	G	DL/I ENTRY DOS/VS	13	DLI
XX9	B	099 0029	AR	PLANCODE/I DOS/VS		PR

PGM NO.	SVC CLS	FESN BASE	COMP	MAIL ADDR.	PROGRAM TITLE	SUPP CODE	FTSC GROUP

5747-SYS/7 & DOS/VS							

AB1	SCP	151	0469	AF	DOS/VS ASM/7		27
AC1	SCP	151	0479	AF	DOS/VS LINK/7		27
AD1	SCP	151	0489	AF	DOS/VS FORMAT/7		27
AE1	SCP	151	0499	AF	DOS/VS MACLIB/R		27
AF1	SCP	151	0609	AF	DOS/VS MSP/7 HPPF		27
AG1	SCP	156	2151	AL	3705 SSP FOR DOS/VS	23	3705 PROG
AZ1	SCP	156	1029	BG	3735 MACROG & UTIL	23	BTAM
BQ1	SCP	156	1171	BT	3790 HOST SUPPORT	02	INDUSTRY SYS
BR1	SCP	156	1181	CM	3600 HOST SUPPORT	02	INDUSTRY SYS
BW1	SCP	156	1191	H	BATCH TRANSFER PROG	03	INDUSTRY SYS
CC3	SCP	156	0181	F	14XX/7010 EMULATOR	63	EMUL
CC6	SCP	156	0190	BX	SSS LEVEL 4	03	INDUSTRY SYS

5748-PP							

AP-101	A	2**	3809	AK	VS APL	13	APL
FO-211	A	2**	3819	AK	VSPC FORTRAN	13	FORTRAN
IF12	B	099	0028		DIDM		
H11	B	099	0029		NEW HEALTH CARE		
XT2	B	099	0028		PSG II/VS-CMS		
XX-111	A	2**	3699	AK	VS/BASIC	13	BASIC
XX3	B	099	0028		DL/1 BRIDGE		
XX4	B	099	0028		DATA BASE DESIGN AID		
XX6	B	099	0028		IIS		

5749-VM/370 - RELEASE 2, 3							

DMK	SCP	154	0429	AG	VM/370 CP	02	VM 370
DMM-00	SCP	154	0709	AG	IPCS	02	VM 370
DMS	SCP	154	0679	AG	VM/370 CMS	02	VM 370
DMT	SCP	154	0689	AG	VM/370 RSCS	02	VM 370
SC-1CD	SCP	154	0729	BG	EREP		02
SC-103	SCP	154	0699	S	VM/370 ASSEMBLER	65	ASSEMBLER

*5752-OS/VS2 RELEASE 030, 037 *							

					REFERENCE TOOLS (SEE PLM SECTION)		
					SYSTEM FICHE INDEX (SEE PLM SECTION)		
BD-TST	SCP	155	1040	BR	DLIB LOAD/INSTALL		02
SC1-8A	SCP	155	1001	AK	JES 3	13	JES 3
SC1-8H	SCP	155	1008	AK	JES 2	13	JES 2
SC1-8N	SCP	155	1015	BN	SYSTEM SECURITY SUPT		02
SC1-8Z	SCP	155	1026	O	MSS RECOVERY SERV		13
SC1-82	SCP	155	1032	AK	EXTERNAL WRITER		13 JOB MGMT
SC1-83	SCP	155	1033	BN	SCHEDULER RESTART		02 JOB MGMT
SC1-84	SCP	155	1034	BN	ALLOC/UNALLOC/VAC		02 JOB MGMT
SC1-85	SCP	155	1035	BN	SWA MANAGER		02 JOB MGMT
SC1-86	SCP	155	1036	BN	INITIATOR TERMINATOR		02 JOB MGMT
** - RECORD THE OPERATING SYSTEM OF PROGRAM PRODUCT:							
DO NOT USE 042 FOR DOS REGARDLESS OF THE RELEASE LEVEL							
OS & OTHER - 01, OS/VS1 - 52, OS/VS2 (REL. 1.X) - 53,							
OS/VS2 (REL. 2 & ABOVE) - 55, VM/370 - 54, DOS - 02,							
DOS/VS - 56							

PAGE OF : G229-2228-20
 REVISED : NOVEMBER 1977
 BY TNL : G425-0005-4

PGM NO.	SVC	FESN	MAIL	PROGRAM TITLE	SUPP	FTSC
	CLS	BASE	COMP	ADDR.	CODE	GROUP
SC1-B8	SCP	155	1038	BN M S COMMANDS	02	JOB MGMT
SC1-B9	SCP	155	1039	BN CONVERTER/INTERPRETER	02	JOB MGMT
SC1-CA	SCP	155	1101	AK DASD ERP	13	ERP
SC1-CB	SCP	155	1102	AK U R ERP	13	ERP
SC1-CC	SCP	155	1103	AK TAPE/ ERP/VES	13	ERP
SC1-CD	SCP	155	1104	BG OBR/EREP/RDE	02	ERP
SC1-CE	SCP	155	1105	BN RMS	02	SUPERVISOR
SC1-CF	SCP	155	1106	BN EXTENDED SVC ROUTER	02	SUPERVISOR
SC1-CG	SCP	155	1107	BN SVC 109	02	SUPERVISOR
SC1-CH	SCP	155	1108	BN VIRT STOR MANGR	02	SUPERVISOR
SC1-CI	SCP	155	1109	O 3851 DSM ERP	13	ERP
SC1-CJ	SCP	155	1111	BN CONTENTS SUPERVISOR	02	SUPERVISOR
SC1-CK	SCP	155	1112	BN COMM TASK	02	SUPERVISOR
SC1-CL	SCP	155	1113	BN TASK MANAGER	02	SUPERVISOR
SC1-CM	SCP	155	1114	BN RECOVERY TERMINATION	02	SUPERVISOR
SC1-CP	SCP	155	1117	AN EXT PREC FLT PNT	02	SUPERVISOR
SC1-CQ	SCP	155	1118	CG MF/1	02	SUPERVISOR
SC1-CR	SCP	155	1119	BN REAL STOR MANAGER	02	SUPERVISOR
SC1-CU	SCP	155	1124	BN REGION CONTROL TASK	02	SUPERVISOR
SC1-CV	SCP	155	1125	BN TIMER SUPERVISOR	02	SUPERVISOR
SC1-CW	SCP	155	1126	BN AUX STOR MANAGER	02	SUPERVISOR
SC1-CX	SCP	155	1127	CG SYSTEM RESOURCE MGR	02	SUPERVISOR
SC1-CY	SCP	155	1128	BS RADIX PARTITION TREE	02	SUPERVISOR
SC1-CZ	SCP	155	1129	BN MP RECONFIGURATION	02	SUPERVISOR
SC1-C2	SCP	155	1132	AK OVERLAY SUPERVISOR	13	SUPERVISOR
SC1-C3	SCP	155	1133	BN IOS	02	IOS
SC1-C4	SCP	155	1134	BN DIOOCS	02	DIOOCS
SC1-C5	SCP	155	1135	BN SUPERVISOR CONTROL	02	SUPERVISOR
SC1-C6	SCP	155	1136	BN EXCP	02	SUPERVISOR
SC1-C7	SCP	155	1137	AK FETCH	13	SUPERVISOR
SC1-C8	SCP	155	1138	BN NIP	02	SUPERVISOR
SC1-C9	SCP	155	1139	BN IPL	02	SUPERVISOR
SC1-DA	SGP	155	1201	AK BLOCK PROCESSOR	13	DATA MGMT
SC1-DB	SCP	155	1202	AK SAM SUBSYSTEM INTFACE	13	DATA MGMT
SC1-DC	SCP	155	1203	AK PASSWORD PROTECT	13	DATA MGMT
SC1-DD	SCP	155	1204	AK 3505/3525 RDR/PCH	02	DATA MGMT
SC1-DE	SCP	155	1205	AK VSAM & VSAM CATALOG	13	DATA MGMT
SC1-DF	SCP	155	1206	AN 3890 DOCUMNT PROCESSOR	02	DATA MGMT
SC1-DG	SCP	155	1207	AK VBP	13	DATA MGMT
SC1-DH	SCP	155	1208	AK CATALOG CNTRLR 3	13	DATA MGMT
SC1-DJ	SCP	155	1211	AK WINDOW INTERCEPT	13	DATA MGMT
SC1-DK	SCP	155	1212	AK ACCESS METHOD SERVICE	13	DATA MGMT
SC1-DL	SCP	155	1213	AN 3886 OCR	02	DATA MGMT
SC1-DN	SCP	155	1215	AN 3540	02	DATA MGMT
SC1-DP	SCP	155	1217	O MSS COMMUNICATOR	13	DATA MGMT
SC1-DQ	SCP	155	1218	O MSC TABLE CREATE	13	DATA MGMT
SC1-DR	SCP	155	1219	O MSS SPACE MANGE	13	DATA MGMT
SC1-DS	SCP	155	1222	O MSS DATA ANALYSIS	13	DATA MGMT
SC1-DT	SCP	155	1223	O MSC TRACE	13	DATA MGMT
SC1-DU	SCP	155	1224	O MSS SERVICES	13	DATA MGMT
SC1-DO	SCP	155	1230	AK SAM	13	DATA MGMT
SC1-D1	SCP	155	1231	AK O/C/EGV	13	DATA MGMT
SC1-D2	SCP	155	1232	AK PAM	13	DATA MGMT

PGM NO.	SVC CLS	FESN BASE	COMP	MAIL ADDR.	PROGRAM TITLE	SUPP CODE	FTSC GROUP
SC1-D4	SCP	155	1234	AK	DADSM		13 DATA MGMT
SC1-D5	SCP	155	1235	AN	OCR		02 DATA MGMT
SC1-D6	SCP	155	1236	AK	MICR		13 DATA MGMT
SC1-D7	SCP	155	1237	AK	DAM		13 DATA MGMT
SC1-D8	SCP	155	1238	AK	ISAM		13 DATA MGMT
SC1-E1	SCP	155	1241	F	EMUL CONTROL		63 EMULATOR
SC1-G0	SCP	155	1640	CF	GAM		02 BTAM
SC1-I0	SCP	155	1540	S	IBCOMPRS		65 UTILITY
SC1-I1	SCP	155	1541	S	IBCDASDI		65 UTILITY
SC1-I2	SCP	155	1542	S	ICAPRTBL		65 UTILITY
SC1-S5	SCP	155	1322	BX	SSS (BASE IND SUPT)		03 INDUSTRY SYS
SC1-S1	SCP	155	1331	AK	SYSGEN		13 SYSGEN
SC1-S2	SCP	155	1332	AK	3330 STARTER		02 SYSGEN
SC1-S3	SCP	155	1333	AK	2314 STARTER		02 SYSGEN
SC1-S4	SCP	155	1334	BN	SUPERVISOR SYSGEN		02 SYSGEN
SC1-S5	SCP	155	1335	BN	SCHEDULER SYSGEN		02 SYSGEN
SC1-S6	SCP	155	1336	BG	SERVICE AIDS SYSGEN		02 SYSGEN
SC1-T0	SCP	155	1430	BN	TSO EDIT		02 TSO
SC1-T1	SCP	155	1431	BN	TSO TEST		02 TSO
SC1-T2	SCP	155	1432	AX	TSO UTILITIES		23 TSO
SC1-T3	SCP	155	1433	AX	TSO TIOC		23 TSO
SC1-T4	SCP	155	1434	BN	TSO SCHEDULER		02 TSO
SC1-T5	SCP	155	1435	AK	LINK LOADGD PROMPTER		13 TSO
SC1-T8	SCP	155	1438	AL	TSO TCAM SUBROUTINES		23 TSO TCAM
SC1-T9	SCP	155	1439	BX	VTIOC/TCAS		02 TSO
SC1-UA	SCP	155	1501	S	IEBPTPCH		65 UTILITY
SC1-UC	SCP	155	1503	S	IEHMOVE		65 UTILITY
SC1-UD	SCP	155	1504	S	IEHINITT		65 UTILIT
SC1-UE	SCP	155	1505	S	IEHSTATR		65 UTILITY
SC1-UF	SCP	155	1506	S	IEHATLAS		65 UTILITY
SC1-UG	SCP	155	1507	AN	IEBTGRIN		02 UTILITY
SC1-UH	SCP	155	1508	S	IEBISAM		65 UTILITY
SC1-UJ	SCP	155	1511	S	IEBDG		65 UTILITY
SC1-UK	SCP	155	1512	S	IEBCOMPR		65 UTILITY
SC1-UM	SCP	155	1514	S	IEBIMAGE		65 UTILITY
SC1-UX	SCP	155	1527	S	SGIEH402		65 UTILITY
SC1-UY	SCP	155	1528	CL	IEHUCAT		02 UTILITY
SC1-U0	SCP	155	1530	S	IEHDASDR		65 UTILITY
SC1-U2	SCP	155	1532	S	IEHLIST		65 UTILITY
SC1-U3	SCP	155	1533	S	IEHPRGGM		65 UTILITY
SC1-U6	SCP	155	1536	S	IEBCOPY		65 UTILITY
SC1-U7	SCP	155	1537	S	IEBGENER		65 UTILITY
SC1-U8	SCP	155	1538	S	IEBUPDTE		65 UTILITY
SC1-U9	SCP	155	1539	S	IEBEDIT		65 UTILITY
SC1-OC	SCP	155	1603	BX	TOLTEP		02 VTAM
SC1-OE	SCP	155	1605	BN	POWER WARNING FEATURE		02 SUPERVISOR
SC1-O0	SCP	155	1630	BN	SMF SCHEDULER		02 JOB MGMT
SC1-O1	SCP	155	1631	BR	MAPPING/SUPVSR		MACRO02 SUPVR MACRO
SC1-O2	SCP	155	1632	BN	SMF		02 JOB MGMT
SC1-O3	SCP	155	1633	S	ASSEMBLER XF		65 ASSEMBLER
SC1-O4	SCP	155	1634	AK	LINKAGE EDITOR		13 LINK EDIT
SC1-O5	SCP	155	1635	AK	LOADER		13 LINK EDIT
SC1-O6	SCP	155	1636	BG	DLTEP		02 DLTEP
SC1-O7	SCP	155	1637	CF	GSP		02 SUPERVISOR
SC1-O8	SCP	155	1638	BR	IVP		02 SUPERVISOR
SC1-O9	SCP	155	1639	AK	CHKPT/RSTR		13 JOB MGMT
SC1-10	C	099	0039	DSS			02
SC1-11	SCP	155	1731	BG	GTF		02 SERVICE AID
SC1-12	SCP	155	1732	BG	AMASPZAP		02 SERVICE AID
SC1-13	SCP	155	1733	BG	AMOPRDMP		02 SERVICE AID

PAGE OF : G229-2228-20
 REVISED : NOVEMBER 1977
 BY TNL : GN25-0005-4

PGM NO.	SVC CLS	FESN BASE	MAIL COMP	MAIL ADDR.	PROGRAM TITLE	SUPP CODE	FTSC GROUP
SC1-14	SCP	155 1734	AK	AMBLIST		13	SERVICE AID
SC1-15	SCP	155 1735	BG	AMDSADMP		02	SERVICE AID
SC1-16	SCP	155 1736	BG	AMAPTFL		02	SERVICE AID
SC1-18	SCP	155 1738	BG	AMDPRDMP EDIT		02	SERVICE AID
SC1-20	SCP	155 1830	CE	BTAM		02	BTAM
SC1-21	SCP	155 1831	AL	TCAM (LEVELS 6,8,9)		23	TCAM
		155 1832	AL	TCAM DIRECT(LEVEL 10)		23	TCAM
SC1-23	SCP	155 1833	BX	VTAM		02	VTAM
SC1-24	SCP	155 4012	CM	3600 HOST SUPPORT		02	INDUSTRY SYS
*SC1-26	SCP	155 3183	BU	CTS-RETAIL HOST		23	INDUSTRY SYS
*SC1-27	SCP	155 3192	BU	CTS-SUPERMARKET HOST		23	INDUSTRY SYS
*SC1-28	SCP	155 3182	AL	CTS-SPPS		23	INDUSTRY SYS
SC1-29	SCP	155 1839	BX	SPS/KE		02	INDUSTRY SYS
SC1-30	SCP	155 1740	CF	HMASMP		02	SMP
SC1-31	SCP	155 1841	AK	3344/3350 AP-1		13	SUPERVISOR

* INDEPENDENT RELEASE - NOT INTEGRATED WITH BASE SYSTEM.

5799

AAA	C	099 0038		PRPQ			
AAB	A	648 0059	H	EMULATOR H120/200		01	
AAE	C	099 0038		G/L COBOL SYM DEBUG			
AAH	C	099 0038		PRPQ			
AAJ	C	099 0038		PRPQ			
AAK	C	099 0038		1800/2260 DATA ENTRY			
AAM	C	099 0038		PRPQ			
AAN	B	099 0028	T	S/S TERMINAL CTL PGM			
AAR	A	648 0229	AJ	PRPQ		02	
AAT	A	648 0239	AJ	PRPQ		02	
AAU	B	099 0028	V	PRPQ			WA
AA-W01	A	648 0259	AK	FORTRAN H EXT PLUS		13	FORTRAN
AAZ	C	099 0038		REQUIRE. PLAN. EXT.			
AAZ	C	099 0038		APPAREL BUSINESS CTL			
ABP	B	099 0029	AB	PRPQ			CH
ACY	C	099 0038		ATS/360 3330 SUPT			
ADA	C	099 0038		S/7 FF TR-1130/1800			
ADB	C	099 0038		S/7 FF TR-05/DOS			
ADG	B	099 0028	AF	S/7 D D D-05/DOS			
ADJ	B	099 0029	AM	S/3 M6 1627 PLOTTER			RG
ADR	C	099 0039		EMUL RCA 301/DOS			
ADT	C	099 0039		EMUL HONW 200/DOS			
ADW	B	099 0029	AM	S/3-10 1627 PLOTTER			RO
ADZ	B	099 0028	AM	S/3-6 1627 PLOTTER			RO
AEB	B	099 0028	AF	S/7 CAS-05/DOS			BR
AEX	C	099 0038		S/7 RDC-05			
AEY	C	099 0038		PRPQ			
AFN	B	099 0028	AF	S/7 TMS-05/DOS			BR
AFZ	A	648 1319	BG	3705 ASCII TRANS		23	3705 PROG
AHA	B	099 0029	AF	S/7 CAS-05/DOS			BR
AJF	B	099 0029		APL SV			
AJR	B	099 0029	AM	S/3 M10 TQF/3			RO
AJT	B	099 0029	AM	S/3 M15 TQF/3			RO
AJW		348 0039	BP	S/7 TTS PRPQ			BR
AKE	B	099 0029	AM	S/3 M10 1255/DPF			RO
ALK	C	099 0038		APL/CMS PRPQ			
ALQ	B	099 0028		PRINTEX/370			
ALR	B	099 0028		PRINTEX/370			
ALX	B	099 0029	AK	GIS DOS/V5		13	
ANR	A	648 2009	AM	S/3 M15 1255 UTIL		10	

PGM NO.	SVC CLS	FESN BASE	MAIL COMP	PROGRAM ADDR.	TITLE	SUPP CODE	FISC GROUP
AQC	B	099	0028	AK	APLSV		13
AQR	A	648	2199	F	NCP PRPQ COMPAT		63
AQT	A	648	2209	F	BSC SWIFT PRPQ		63
AQY	A	648	2239	F	NCP PRPQ COMPAT		63
ARD	B	099	0028		FIN SERV TERM		
ARE	B	099	0028		FSTS		
ARG	A	648	2089		3350/3330 MOD 11		
ARG-CA	A	648	2089	AK	DASD ERP	13	SUPERVISOR
ARG-CB	A	648	2089	AK	UNIT RECORD ERP	13	SUPERVISOR
ARG-CC	A	648	2089	O	SVC-91	13	SUPERVISOR
ARG-C2	A	648	2089	BG	SUPERVISOR	02	SUPERVISOR
ARG-C3	A	648	2089	AK	IOS	13	SUPERVISOR
ARG-C5	A	648	2089	AX	SCHEDULER	02	JOB MGMT
ARG-C9	A	648	2089	AK	SYSGEN	13	SYSGEN
ARG-D2	A	648	2089	AK	SAM/DAM/PAM	13	DATA MGMT
ARG-D3	A	648	2089	BG	OLTEP	02	OLTEP
ARG-D4	A	648	2089	AK	DADSM	13	DATA MGMT
ARG-D7	A	648	2089	BG	OBR/EREP	02	SUPERVISOR
ARG-D9	A	648	2089	BG	RMS	02	SUPERVISOR
ARG-IO	A	648	2089	AK	ISAM	13	DATA MGMT
ARG-SC	A	648	2089	AK	AP-1	13	SUPERVISOR
ARG-UH	A	648	2089	S	IEHATLAS	65	UTILITY
ARG-UK	A	648	2089	S	IEHDASDR	65	UTILITY
ARG-UN	A	648	2089	AK	SVC-98	13	UTILITY
ARG-UY	A	648	2089	S	IEBCOPY	65	UTILITY
ARG-U2	A	648	2089	S	IBCDMPRS	65	UTILITY
ARG-U3	A	648	2089	S	IBCDASDI	65	UTILITY
ARG-U5	A	648	2089	S	IEHLIST	65	UTILITY
ARQ	A	648	2159	AG	VM/370 RESOURCE MGT	02	VM 370
ATA	A	648	2149	BY	VM/370 NJI		02
ATB	B	099	0028		ASP NETWORKING		
ATC	A	648	2179		HASP NETWORKING		
IATQ	B	099	0028		HASP/MVT/3800		
WAA	A	649	0029		FILM RDR/RECORDER	02	
WAB	A	649	0079	AK	2740/2968 A/V CTL PK	13	
WAC	C	099	0038		PSHRPQ		
WAD	SCP	549	0019	AM	S/3 M10 C 1017 IOCS	10	
WAE	SCP	549	0029	AM	S/3 M10 D 1017 IOCS	10	
WAF	C	099	0039		PSHRPQ		
WA-GC0	C	099	0038		PSHRPQ		
WAH	C	099	0038		2969-1 CTL PROG		
WAM	SCP	549	0069	AM	S/3 M10 C 1018 IOCS	10	
WAN	SCP	549	0079	AM	S/3 M10 D 1018 IOCS	10	
WAU	SCP	549	0089	AP	S/3 M10 D MLTA IOCS	10	
WAZ	C	099	0038		S/7 BSC-OS/DOS		
WBA	C	099	0038		S/7 BSC-1130		
WBB	C	099	0038		S/7 TPMM ASC-1130		
WBC	C	099	0038		S/7 TPMM ASC-OS/DOS		
WBD	C	099	0038		S/7 7414-OS/DOS		
WBE	C	099	0038		S/7 7414-1130/1800		
WBF	C	099	0038		S/7 TAPE-1130/1800		
WBG	C	099	0038		S/7 TAPE-OS/DOS		
WBH	C	099	0038		S/7 1017-1130/1800		
WBJ	C	099	0038		S/7 1017-OS/DOS		
WBT	C	099	0038		S/7 CX/BPE-1130/1800		
WBW	C	099	0038		S/7 CX/BPE-OS/DOS		
WBZ	C	099	0038		S/7 1018-1130/1800		
WCA	C	099	0038		S/7 1018-OS/DOS		

PAGE OF : G229-2228-20
 REVISED : NOVEMBER 1977
 BY TNL : GN25-0005-4

PGM NO.	SVC CLS	FESN BASE	COMP	MAIL ADDR.	PROGRAM TITLE	SUPP CODE	FTSC GROUP
WCB	A	649	0619	AF S/7	CH ATT-OS/DOS	27	
WCE	SCP	549	0099	AP S/3	M10 C 2501 ATT	10	
WCF	SCP	549	0109	AP S/3	M10 D 2501 ATT	10	
WCG	C	099	0038	S/7	1627-OS/DOS		
WCH	C	099	0038	S/7	1627-1130/1800		
WCT	C	099	0039	S/7	SBCA-OS/DOS		
WCW	C	099	0038	S/7	MAG RDR-OS/DOS		
WCY	B	099	0028	AF S/7	TAPE CASSETTE	BR	
WCZ	C	099	0038		5930 BTAM DOS		
WDA	C	099	0038		5930 BTAM OS		
WDB	C	099	0038	S/7	CD REC-1130/1800		
WDC	C	099	0038	S/7	CD REC-OS/DOS		
WDD	C	099	0038	S/7	7431-1130/1800		
WDE	C	099	0038	S/7	7431-OS/DOS		
WDF	SCP	549	0119	AM S/3	MOD6 1017 IOCS	10	
WDG	C	099	0038	S/7	029 CD RDR ATT		
WDK	C	099	0038	S/7	SBCU-OS		
WDL	SCP	549	0129	AM S/3	MOD6 1018 IOCS	10	
WDM	C	099	0038	S/7	TPMM ASC-1800		
WDM	C	099	0038	S/7	BSC-1800		
WDP	SCP	549	0179	AM S/3	M10 1017/1442	10	
WDT	SCP	549	0169	AM S/3	M10 2793/2797	10	
WEA	B	099	0028	AF S/7	AUD RESP-OS/DOS	BR	
WEC	B	099	0028	AF S/7	I T S-OS/DOS	BR	
WEH	C	099	0038	S/7	3410 ATTACHMENT		
WER	B	099	0029	AM S/3	M10 3735 SUPPORT	RO	
WEZ	C	099	0038		DOS SUPPORT 3735		
WFD	SCP	549	0209	AM S/3	M10 1018/1442	10	
WFE	B	099	0028	AF S/7	EXT ITS-OS/DOS	BR	
WFF	C	099	0038	S/7	TPMM BSC-1130		
WFG	A	649	1649	AF S/7	TPMM BSC-OS/DOS	27	
WFH	C	099	0038	S/7	TPMM BSC-1800		
WFJ	SCP	549	0219	AM S/3	DUMP/RESTORE	10	
WFK	SCP	549	0229	AP S/3	M15 A/B/C MLTA	10	
WGF	A	649	1709	CC	5930 BTAM 2701/2/3	63	
WGG	A	649	1719	CC	5930 BTAM 2701/2/3	63	
WGH	A	649	1729	CC	5930 BTAM 2701/2/3	63	
WGJ	A	649	1739	CC	5930 BTAM 3704/5	63	
WGL	A	649	1759	CC	5930 BTAM 3704/5	63	
WGX	SCP	549	0339	AP S/3	M10 D 2956 ATT	10	
WGY	SCP	549	0349	AP S/3	M10 INT. TIMER	10	
WGZ	A	649	1789	AM S/3	M15 FORTRAN	10	
WHG	SCP	549	0379	AP S/3	M10 BSCA MODIF	10	
WHL	SCP	549	0399	AP S/3	M10 2ND 1403 ATT	10	
WHP	SCP	549	0409	AM S/3	M15 1017 IOCS	10	
WHQ	B	099	0029	AM S/3	M15 3735 SUPPORT	RO	
WHT	SCP	549	0419	AM S/3	M15 1018 IOCS	10	
WHX	B	099	0028		DOS/V5 RJE WK STAT		
WHZ	B	099	0028		3333/3330 DISK STORAGE		
WJH	SCP	549	0469	AF S/7	3340 ATT OS/V5	27	
WJJ	SCP	549	0479	AF S/7	3340 ATT DOS/V5	27	
WJK	SCP	549	0489	AF S/7	3340 ATT	27	
WJX	A	649	2019	AF S/7	3340 ATT DOS	27	
WJY	A	649	2029	AF S/7	3340 ATT OS	27	
WJW	A	649	2079	CJ	3890 PRPQ SUPPORT	C2	DATA MGMT
WKH	SCP	549	0579	AP S/3	M12 MLTA IOCS	10	
WLD	SCP	549	2089	AP S/3	M15 D MLTA IOCS	10	
7040, 7080, 7090							
-ALL-	C	099	0039		-ALL 7040, 7080, 7090 PROGRAMS-		

031 7770 FIELD DEVELOPED PGMS

OLT APAR MAILING LIST

THIS LIST PROVIDES THE COMPONENT IDENTIFICATION NUMBERS USED IN CONJUNCTION WITH THE AUTHORIZED PROGRAM ANALYSIS REPORT (APAR), LOCATION "N" ON THE FORM. THE ID NUMBERS REFERENCE THE MAJOR OLT "FAMILY" AND ARE LISTED NUMERICALLY. ENTER RUN NAME AND VERSION LEVEL IN LOCATION "S". THE FIRST WORD OF THE ABSTRACT SHOULD CORRESPOND TO THE SYMPTOM CODE, ALSO INCLUDE THE OP SYSTEM RELEASE LEVEL IF NOT OPERATING UNDER OLTSEP. AN ADDRESS CODE IS LISTED BESIDE EACH COMPONENT IDENTIFICATION NUMBER WHICH REFERENCES THE APAR MAILING ADDRESS.

<u>COMPONENT</u>	<u>MAIL_ADDR.</u>	<u>COMPONENT</u>	<u>MAIL_ADDR.</u>
OLTS0200A	BD	OLTS2820A	BD
OLTS0370A	BJ	OLTS2821A	AN
OLTS1012A	BD	OLTS2826A	BE
OLTS1030A	X	OLTS2835A	BD
OLTS1050A	X	OLTS2841A	BD
OLTS1060A	X	OLTS2845A	X
OLTS1231A	AQ	OLTS2848A	X
OLTS1255A	AN	OLTS2947A	BK
OLTS1270A	BE	OLTS2955A	AH
OLTS1275A	BE	OLTS2970A	AD
OLTS1285A	AQ	OLTS2972A	AD
OLTS1287A	AQ	OLTS2976A	X
OLTS1288A	AQ	OLTS3155A	BH
OLTS1403A	AN	OLTS3158A	BH
OLTS1404A	AN	OLTS3165A	BJ
OLTS1419A	AN	OLTS3168A	BJ
OLTS1442A	AQ	OLTS3210A	AN
OLTS1443A	AN	OLTS3215A	AN
OLTS1445A	AN	OLTS3270A	AD
OLTS2150A	BJ	OLTS3271A	AD
OLTS2245A	BB	OLTS3330A	BD
OLTS2250A	AD	OLTS3340A	BD
OLTS2260A	X	OLTS3410A	CD
OLTS2265A	X	OLTS3420A	CD
OLTS2301A	BD	OLTS3505A	AQ
OLTS2303A	BD	OLTS3525A	AQ
OLTS2305A	BD	OLTS3540A	AQ
OLTS2311A	BD	OLTS3670A	X
OLTS2313A	BD	OLTS3700A	X
OLTS2314A	BD	OLTS3704A	X
OLTS2321A	BD	OLTS3705A	X
OLTS2400A	CD	OLTS3735A	X
OLTS2495A	BG	OLTS3811A	AN
OLTS5201A	AQ	OLTS3830A	BD
OLTS2520A	AQ	OLTS3850A	G
OLTS2540A	AN	OLTS3881A	AQ
OLTS2596A	AQ	OLTS3886A	AQ
OLTS2671A	BC	OLTS3890A	AN
OLTS2700A	X	OLTS3945A	BE
OLTS2701A	X	OLTS4640A	AN
OLTS2702A	X	OLTS5010A	BV
OLTS2703A	X	OLTS5098A	BV
		OLTS5998A	BV
OLTS2715A	X	OLTS7770A	X
OLTS2740A	X	OLTSSEPCO	BG
OLTS2741A	X	OLTSSEPD T	BG
OLTS2760A	X	OLTSOSPB	BG
		OLTSWINCO	BG

APAR MAILING ADDRESSES

- D- DELETED JANUARY 1976
- E- *SEE INSTRUCTIONS FOR SUBMITTAL OF APARS
TO EUROPEAN LOCATIONS.
- F- *SEE INSTRUCTIONS FOR SUBMITTAL OF APARS
TO EUROPEAN LOCATIONS.
- G- *SEE INSTRUCTIONS FOR SUBMITTAL OF APARS
TO EUROPEAN LOCATIONS.
- H- *SEE INSTRUCTIONS FOR SUBMITTAL OF APARS
TO EUROPEAN LOCATIONS.
- J- DELETED MARCH 1976
- K- DELETED MARCH 1976
- N- IBM CORPORATION
APAR PROCESSING
DEPT. 772
1133 WESTCHESTER AVE.
WHITE PLAINS, N. Y. 10604
-NO PREPAID MAILING LABEL-
- D- IBM CORPORATION
APAR PROCESSING
P.O. BOX 1900
BOULDER, COLORADO 80302
-NO PREPAID MAILING LABEL-
- R- IBM CORPORATION
APAR PROCESSING
LOS ANGELES DEVELOPMENT CENTER
1930 CENTURY PARK WEST
LOS ANGELES, CALIFORNIA 90067
-NO PREPAID MAILING LABEL-
- S- *SEE INSTRUCTIONS FOR SUBMITTAL OF APARS
TO EUROPEAN LOCATIONS.
- T- IBM CORPORATION
2651 STRANG BLVD.
DEPT. 935
YORKTOWN HEIGHTS, N. Y. 10598
ATTN: MR. ELLIS JONES
-NO PREPAID MAILING LABEL-
- U- IBM CORPORATION
APAR PROCESSING
DEPT. 835
112 EAST POST ROAD
WHITE PLAINS, N. Y. 10601
-NO PREPAID MAILING LABEL-

* - WORLD TRADE LOCATIONS SHOULD NOT MAIL APARS
TO THESE ADDRESSES. REFER TO WORLD TRADE
GENERAL PSM NO. 1 FOR PROPER APAR MAILING
ADDRESSES IF YOU ARE SUBMITTING AN APAR FROM
A WORLD TRADE LOCATION.

V- IBM CORPORATION
APAR PROCESSING
WASHINGTON DEVELOPMENT CENTER
11141 GEORGIA AVE.
WHEATON, MARYLAND 20902
-NO PREPAID MAILING LABEL-
W- DELETED SEPTEMBER 1976
X- IBM CORPORATION
APAR PROCESSING
DEPT. G62, BLDG. 061
RESEARCH TRIANGLE PARK, N. C. 27709
-NO PREPAID MAILING LABEL-
Y- DELETED MARCH 1976
AA- DELETED MARCH 1977 (SEE AK)
AB- IBM CORPORATION
APAR PROCESSING
TECHNICAL SERVICES MANAGER
380 NORTHWEST HIGHWAY
DES PLAINES, ILLINOIS 60016
-NO PREPAID MAILING LABEL-
AC- IBM CORPORATION
APAR PROCESSING
DEPT. 888 - 3RD FLOOR
1350 AVENUE OF THE AMERICAS
NEW YORK, N. Y. 10019
-NO PREPAID MAILING LABEL-
AD- IBM CORPORATION
DEPT. 57Q, BLDG. 202
NEIGHBORHOOD ROAD
KINGSTON, N. Y. 12401
-NO PREPAID MAILING LABEL-
AE- IBM CORPORATION
SERIES/I APAR CONTROL
P.O. BOX 1328
BOCA RATON, FLORIDA 33432
-NO PREPAID MAILING LABEL-
AF- IBM CORPORATION
APAR PROCESSING
DEPT. 23B, BLDG. 203
P.O. BOX 1328
BOCA RATON, FLORIDA 33432
-NO PREPAID MAILING LABEL-
AG- IBM CORPORATION
APAR PROCESSING
DEPT. H68, BLDG. 706-2
| P.O. BOX 390/BOARDMAN ROAD
POUGHKEEPSIE, N. Y. 12602
-NO PREPAID MAILING LABEL-

PAGE OF : G229-2228-20
REVISED : NOVEMBER 1977
BY TNL : GN25-0005-4

AH- IBM CORPORATION
MAINTENANCE TECHNOLOGY APAR COORDINATOR
P.O. BOX 12195
DEPT. 817-X585, BLDG. 051
RESEARCH TRIANGLE PARK, N. C. 27709
-NO PREPAID MAILING LABEL-

AJ- IBM CORPORATION
GEM REGION DESIGN CENTER
APAR PROCESSING
10401 FERNWOOD ROAD
BETHESDA, MD. 20034
-NO PREPAID MAILING LABEL-

AK- IBM CORPORATION
APAR PROCESSING
SANTA TERESA LAB
555 BAILEY AVE.
P. O. BOX 50020
SAN JOSE, CALIFORNIA 95150
-PREPAID MAILING LABEL FORM NO. S229-2159-

AL- IBM CORPORATION
APAR PROCESSING
BOX 12134
RESEARCH TRIANGLE PARK, N. C. 27709
-PREPAID MAILING LABEL FORM NO. S229-2160-

AM- IBM CORPORATION
APAR PROCESSING
DEPT. 430
3605 HIGHWAY 52 N.
ROCHESTER, MINN. 55901
-NO PREPAID MAILING LABEL-

AN- IBM CORPORATION
APAR PROCESSING
DEPT. 74C, MODULE 20
P.O. BOX 6
ENDICOTT, N. Y. 13760
-PREPAID MAILING LABEL FORM NO. S229-2236-

AO- IBM CORPORATION
APAR PROCESSING
CUSTOM SYSTEMS PROGRAMMING
I P.O. BOX 390/BOARDMAN ROAD
DEPT. C47, BLDG. 702
POUGHKEEPSIE, N. Y. 12602
-NO PREPAID MAILING LABEL-

AP- IBM CORPORATION
SYSTEM/3 APAR CONTROL
DEPT. 252
37TH ST., HIGHWAY 52 N.W.
ROCHESTER, MINN. 55901
-NO PREPAID MAILING LABEL-

AQ- IBM CORPORATION
DEPT. 400
HIGHWAY 52 AND NW 37TH STREET
ROCHESTER, MINN. 55901
-NO PREPAID MAILING LABEL-

AR- DELETED MARCH 1977

AS- DELETED OCTOBER 1977
AT- DELETED APRIL 1977
AV- DELETED MARCH 1976
AW- IBM CORPORATION
DEPT. LS1
3540 APAR PROC.
18100 FREDERICK PIKE
GAITHERSBURG, MD. 20760
-NO PREPAID MAILING LABEL-
AX- IBM CORPORATION
APAR PROCESSING
P. O. BOX 12134
DEPT. 944, X585
RESEARCH TRIANGLE PARK, N. C. 27709
-NO PREPAID MAILING LABEL-
AY- IBM CANADA, LTD.
1445 WEST GEORGIA STREET
VANCOUVER 5, BRITISH COLUMBIA
CANADA
-NO PREPAID MAILING LABEL-
AZ- IBM CORPORATION
APAR PROCESSING
DEPT. D54, BLDG. 705
I P.O. BOX 390/BOARDMAN ROAD
POUGHKEEPSIE, N. Y. 12602
-NO PREPAID MAILING LABEL-
BA- IBM U. K. LABORATORIES, LTD.
MAILPOINT 168
HURSLEY PARK, WINCHESTER
HANTS, ENGLAND
-NO PREPAID MAILING LABEL-
BB- IBM JAPAN
DEPT. 811, RAS
1 KIRIHARA-CHO, FUJISAWA-SHI
KANAGAWA-KEN
JAPAN 252
-NO PREPAID MAILING LABEL-
BC- IBM CORPORATION
CER - DEPT. 0766
06610 LAGAUE, FRANCE
-NO PREPAID MAILING LABEL-
BD- IBM CORPORATION
APAR PROCESSING
DEPT. D06, BLDG. 026
5600 COTTLE ROAD
SAN JOSE, CALIFORNIA 95193
-NO PREPAID MAILING LABEL-
BE- IBM CORPORATION
A. DE BOER
RAS DEPARTMENT
P.O. BOX 24
UITHOORN, NETHERLANDS
-NO PREPAID MAILING LABEL-
BF- DELETED JUNE 1977

* - WORLD TRADE LOCATIONS SHOULD NOT MAIL APARS
TO THESE ADDRESSES. REFER TO WORLD TRADE
GENERAL PSM NO. 1 FOR PROPER APAR MAILING
ADDRESSES IF YOU ARE SUBMITTING AN APAR FROM
A WORLD TRADE LOCATION.

PAGE OF : G229-2228-20
REVISED : NOVEMBER 1977
BY TNL : GN25-0005-4

BG- IBM CORPORATION
APAR PROCESSING (ENTER PROGRAM NUMBER ON LABEL)
DEPT. 77Q LOCATION Z6-2-3C-63
18100 FREDERICK PIKE
GAITHERSBURG, MD. 20760
-NO PREPAID MAILING LABEL-

BH- IBM CORPORATION
APAR COORDINATOR
DEPT. D61, BLDG. 705
| P.O. BOX 390/BOARDMAN ROAD
POUGHKEEPSIE, N. Y. 12602
-NO PREPAID MAILING LABEL-

BJ- IBM CORPORATION
APAR COORDINATOR
DEPT. 874, BLDG. 707
| P.O. BOX 390/BOARDMAN ROAD
POUGHKEEPSIE, N. Y. 12602
-NO PREPAID MAILING LABEL-

BK- IBM CORPORATION
APAR COORDINATOR
DEPT. C47, BLDG. 702
| P.O. BOX 390/BOARDMAN ROAD
POUGHKEEPSIE, N. Y. 12602
-NO PREPAID MAILING LABEL-

BL- IBM CORPORATION
APAR PROCESSING
DEPT. 70R
1133 WESTCHESTER AVE.
WHITE PLAINS, N. Y. 10604
-NO PREPAID MAILING LABEL-

BM- IBM CORPORATION
APAR PROCESSING
DEPT. D82, BLDG. 706
| P.O. BOX 390/BOARDMAN ROAD
POUGHKEEPSIE, N. Y. 12602
-NO PREPAID MAILING LABEL-

BN- IBM CORPORATION
APAR PROCESSING
DEPT. D11, BLDG. 706
| P.O. BOX 390/BOARDMAN ROAD
POUGHKEEPSIE, N. Y. 12602
-NO PREPAID MAILING LABEL-

BO- IBM CORPORATION
APAR PROCESSING
2800 SAND HILL ROAD
MENLO PARK, CALIFORNIA 94025
-NO PREPAID MAILING LABEL-

BP- IBM CORPORATION
APAR PROCESSING
DEPT. 21Z031 1
P.O. BOX 1326
BOCA RATON, FLORIDA 33432
-NO PREPAID MAILING LABEL-

BQ- DELETED MARCH 1977 (SEE AK)

BR- IBM CORPORATION
APAR PROCESSING
DEPT. D94, BLDG. 706
| P.O. BOX 390/BOARDMAN ROAD
POUGHKEEPSIE, N. Y. 12602
-NO PREPAID MAILING LABEL-

- BS- IBM CORPORATION
APAR PROCESSING
DEPT. 852, BLDG. 707
| P.O. BOX 390/BOARDMAN ROAD
POUGHKEEPSIE, N. Y. 12602
-NO PREPAID MAILING LABEL
- BT- IBM CORPORATION
APAR PROCESSING
DEPT. 63M, BLDG. 201-2
NEIGHBORHOOD ROAD
KINGSTON, N. Y. 12401
-NO PREPAID MAILING LABEL-
- BU- IBM CORPGRATION
BLDG. 602
P.O. BOX 12134
RESEARCH TRIANGLE PARK, N. C. 27709
ATTN: APAR COORDINATOR DEPT. F32/D537
-NO PREPAID MAILING LABEL
- BV- IBM CORPORATION
APAR PROCESSING
DEPT. 26N, BLDG. 203
P.O. BOX 1328
BOCA RATON, FLORIDA 33432
-NO PREPAID MAILING LABEL-
- BW- IBM CORPORATION
1439 PEACHTREE STREET N.E.
ATLANTA, GEORGIA 30309
ATTN: W. W. LYONS
-NO PREPAID MAILING LABEL-
- BX- IBM CORPGRATION
APAR PROCESSING
DEPT. 74M, BLDG. 001
NEIGHBORHOOD ROAD
KINGSTON, N. Y. 12401
-NO PREPAID MAILING LABEL-
- BY- IBM CAMBRIDGE SCIENTIFIC CENTER
545 TECHNICAL SQUARE
CAMBRIDGE, MASS. 02139
-NO PREPAID MAILING LABEL-
- CB- *SEE INSTRUCTIONS FOR SUBMITTAL OF APARS
TO EUROPEAN LOCATIONS.
- CC- IBM CORPORATION
SYSTEM/32 APAR CONTROL
DEPT. 540
37TH STREET AND HIGHWAY 52 NW
ROCHESTER, MINN. 55901
-NO PREPAID MAILING LABEL-
- CD- IBM CORPORATION
APAR PROCESSING
DEPT. 677, BLDG. 142
5600 COTTLE ROAD
SAN JOSE, CALIFORNIA 95114
-NO PREPAID MAILING LABEL-
- CE- IBM CORPORATION
APAR PROCESSING
P. O. BOX 12134
DEPT. 943, X585
RESEARCH TRIANGLE PARK, N. C. 27709
-NO PREPAID MAILING LABEL-

* - WORLD TRADE LOCATIONS SHOULD NOT MAIL APARS TO THESE ADDRESSES. REFER TO WORLD TRADE GENERAL PSM NO. 1 FOR PROPER APAR MAILING ADDRESSES IF YOU ARE SUBMITTING AN APAR FROM A WORLD TRADE LOCATION.

PAGE OF : G229-2228-20
REVISED : NOVEMBER 1977
BY TNL : GN25-0005-4

CF- IBM CORPORATION
APAR PROCESSING
P. O. BOX 12134
DEPT. 942, X585
RESEARCH TRIANGLE PARK, N. C. 27709
-NO PREPAID MAILING LABEL-

CG- IBM CORPORATION
APAR PROCESSING
DEPT. D95, BLDG. 705
I P.O. BOX 390/BOARDMAN ROAD
POUGHKEEPSIE, N. Y. 12602
-NO PREPAID MAILING LABEL-

CH- DELETED FEBRUARY 1976

CI- IBM CORPORATION
EXTM APAR PROCESSING
P. O. BOX 12195
DEPT. 997, H589
RESEARCH TRIANGLE PARK, N. C. 27709
-NO PREPAID MAILING LABEL-

CJ- IBM CORPORATION
FINANCE INDUSTRY DEVELOPMENT
DEPT. 849
1133 WESTCHESTER AVE., 1-CP
WHITE PLAINS, N. Y. 10604
-NO PREPAID MAILING LABEL-

CK- IBM CORPORATION
APAR PROCESSING COORDINATOR
TCS-PROGRAM DEVELOPMENT
DEPT. 82L
1133 WESTCHESTER AVENUE
WHITE PLAINS, N. Y. 10604
-NO PREPAID MAILING LABEL-

CL- IBM CORPORATION
APAR PROCESSING
DEPT. D91, BLDG. 707
I P.O. BOX 390/BOARDMAN ROAD
POUGHKEEPSIE, N. Y. 12602
-NO PREPAID MAILING LABEL-

CM- IBM CORPORATION
APAR PROCESSING
DEPT. 56B, BLDG. 003
NEIGHBORHOOD ROAD
KINGSTON, N. Y. 12401
-NO PREPAID MAILING LABEL-

CN- IBM CORPORATION
APAR PROCESSING
TCAM IMS INTERFACE
DEPT. 69M/037-PAS4
1501 CALIFORNIA AVE.
PALO ALTO, CALIFORNIA 94304
-NO PREPAID MAILING LABEL-

CX- DELETED JANUARY 1977

DA- IBM CORPORATION
APAR PROCESSING
DEPT. D93N, BLDG. 203
P. O. BOX 1328
BOCA RATON, FLORIDA 33432
-NO PREPAID MAILING LABEL-

DB- IBM CORPORATION
APAR PROCESSING
DEPT. D26W
2800 SAND HILL ROAD
MENLO PARK, CAL. 94025
-NO PREPAID MAILING LABEL-

FESER MAILING ADDRESSES

SUPPORT CODE	
01, 02, 03	IBM CORPORATION
62, 63	PROGRAMMING SYSTEM MGR.
64, 66	BLDG. 947 DEPT. H74
	IBM ROAD
	POUGHKEEPSIE, N. Y. 12602
10	IBM CORPORATION
	SERVICE PLANNING MANAGER
	BLDG. 109, DEPT. 900
	37TH ST., HIGHWAY 52 N.W.
	ROCHESTER, MN. 55901
13, 65	IBM CORPORATION
	PROGRAMMING SYSTEMS MGR.
	DEPT. T20
	555 BAILEY AVE.
	SAN JOSE, CA. 95150
23	IBM CORPORATION
	SERVICE PLANNING MANAGER
	DEPT. 952/A073
	BLDG. 060
	RESEARCH TRIANGLE PARK
	RALEIGH, N. C. 27709
27	IBM CORPORATION
	P.O. BOX 1328
	BLDG. 001-3, DEPT. 90A
	BOCA RATON, FLA. 33432

PAGE OF : G229-2228-20
REVISED : NOVEMBER 1977
BY TNL : GN25-0005-4

IN ADDITION TO PLM NUMBERS, THIS SECTION NOW INCLUDES THE MICROFICHE NUMBERS. THE FTSC GROUP HAS BEEN MOVED TO THE PROGRAM ID PAGES.

PROGRAM TITLE PROGRAM PLM_NUMBER(S) MICROFICHE_NO.

36QA-APPLICATION

ASP SYS OS VER 2	CX-15X	GY20-0305	GY80-0508
ASP SYS OS VER 3	CX-15X	GY20-0305	GY80-0854
DOS MACLIB/RELOCATE	TX-016	GY34-0010	GJ01-1790
			GJ01-1794
OS MACLIB/RELOCATE	TX-026	GY34-0010	GJ01-1790
			GJ01-1794

36QD-APPLICATION

HASP	51014		GY80-0512
------	-------	--	-----------

36QH-3705

3705 EP SUPPORT	TX-033	SY30-3001	GJ02-4102
3705 NCP FOR OS	TX-034	SY30-3003	GJ02-4105
3705 SSP FOR OS	TX-035	SY30-3001	GJ02-4101

36QN-DOS

DOS/360 FORTRAN IV	FD-479	GY28-6394	GJ01-2056
			GJC7-1922
DOS/360 FORT4 LIB	LM-480		GJ01-2056
			GJC7-1923

36QP-BPS

OS/360 DASDI	UT-213		
OS/360 DUMP RESTORE	UT-214		
OS/360 RECOVERY	UT-215		

37QH

HASP II VERSION 4	TX-001		GY80-0856
-------------------	--------	--	-----------

<u>PROGRAM TITLE</u>	<u>PROGRAM</u>	<u>PLM NUMBER(S)</u>	<u>MICROFICHE NO.</u>
<u>5701-SYS/3-MOD 10 (CARD SYSTEM)</u>			
S/3 CARD SYSTEM	SC1	SY21-0521	
<u>5702-SYS/3-MOD 10 (DISK SYSTEM)</u>			
S/3 ANS COBOL	CB1	LY28-6421	LYC7-1347
S/3 BASIC ASSEM	AS1	LY21-0504	LYC7-1303
S/3 CARD UTILITIES	UT1	LY21-0523	LYC7-1302
S/3 DISK SYSTEM	SC1	SY21-0502	SYC7-1100
		SY21-0503	SYC7-1121
		SY21-0512	SYC7-1123
		SY21-0526	
		SY21-0527	
		SY21-0531	
		SY21-0543	
		SY21-0544	
S/3 DISK RPG II	RG1	LY21-0501	LYC7-1300
			LYC7-1342
S/3 DISK SORT	SM1	LY21-0517	LYC7-1301
S/3 FORTRAN IV	F01	LY28-6848	LYC7-5046
S/3 1255-UTILITY	UT2	LY21-0016	LYC7-1304
<u>5703-SYS/3-MOD 4 & 6</u>			
S/3 CCP/DISK SORT	SM2		LYC7-1341
S/3 CONV UTIL	UT1	LY21-0524	LYC7-1310
S/3 DISK RPG II	RG1	LY21-0501	LYC7-1307
			LYC7-1343
S/3 DISK SORT	SM1	LY21-0517	LYC7-1309
S/3 DISK SYSTEM	SC1	SY21-0502	SYC7-1103
		SY21-0503	SYC7-1124
		SY21-0512	SYC7-1138
		SY21-0526	
		SY21-0531	
		SY21-0544	
S/3 FORTRAN IV	F01	LY28-6848	LYC7-5046
<u>5704-SYS/3 MOD 15</u>			
S/3 ANS COBOL	CB1,CB2	LY28-6421	LYC7-1323
			LYC7-1347
S/3 BASIC ASSEMBLER	AS1,AS2	LY21-0504	LYC7-1322
			LYC7-1346
S/3 DISK SYSTEM	SC1	SY21-0032	SYC7-1125
	SC1,SC2	SY21-0033	SYC7-1126
	SC1,SC2	SY21-0034	SYC7-1132
	SC1,SC2	SY21-0035	
	SC1,SC2	SY21-0036	
	SC1,SC2	SY21-0040	
	SC2	SY21-0052	SYC7-1140
	SC1,SC2	SY21-0526	SYC7-1141
	SC1,SC2	SY21-0543	SYC7-1142
	SC1,SC2	SY21-0552	

PAGE OF : G229-2228-20
 REVISED : NOVEMBER 1977
 BY TNL : GN25-0005-4

<u>PROGRAM TITLE</u>	<u>PROGRAM</u>	<u>PLM NUMBER(S)</u>	<u>MICROFICHE NO.</u>
S/3 FORTRAN	F01,F02	LY28-6848	LYC7-1328 LYC7-1348
S/3 RPG	RG1,RG2	LY21-0501	LYC7-1324 LYC7-1344 LYC7-1349
S/3 DISK SORT	SM1,SM9	LY21-0517	LYC7-1325 LYC7-1350
S/3 TAPE SORT	SM7 SM2,SM8	LY21-0517 LY21-0529	LYC7-1351 LYC7-1326 LYC7-1352
S/3 CARD UTILITIES	UT1,UT3	LY21-0031	LYC7-1327 LYC7-1353

5705-SYS/3 MOD 12

BASIC ASSEMBLER	AS1	LY21-0504	LYC7-1333
COBOL	CB1	LY28-6421	LYC7-1334
DISK SCP	SC1	SY21-0045 SY21-0046 SY21-0526 SY21-0527 SY21-0531 SY21-0544	SYC7-1134 SYC7-1135 SYC7-1136
DISK SORT	SM1	LY21-0517	LYC7-1337
FORTRAN IV	F01	LY28-6848	LYC7-1335
RPG	RG1	LY21-0501	LYC7-1336 LYC7-1345
TAPE SORT	SM2	LY21-0529	LYC7-1338
UTILITIES	UT1	LY21-0031	LYC7-1339
1255 UTILITIES	UT2	LY21-0016	LYC7-1334

5707-SYS/7

MSP/7 ASM/7	AD1		SJD1-1791
MSP/7 DSS/7	SC2	GY34-0011	
MSP/7 DSS/7 8-12K	AG1		SJD1-1792
MSP/7 FORT IV	F01		
MSP/7 LINK/7	AF1		SJD1-1791
MSP/7 PROCLIB	AB1		
MSP/7 SLE	AE1		SJD1-1791
MSP/7 SYSCODE	AC1	GY34-0012	GJD1-1790 GJD1-1794
SYS/7 PPF	AA1		SJD1-1791

5718-SYS/7

S/7 SCP	SC2		
---------	-----	--	--

<u>PROGRAM TITLE</u>	<u>PROGRAM</u>	<u>PLM_NUMBER(S)</u>	<u>MICROFICHE_NO.</u>
<u>5719-SERIES/1</u>			
FC/PM2,3,APPU	U12	LH30-0178	
		LH30-0179	
FORTRAN IV COMP & OBJ	F01	LY34-0134	LJD1-1817
FORTRAN IV REALTIME	F03	LY34-0135	LJD1-1818
MFSL	LM1	LY34-0139	LJD1-1821
PL/1 COMP & RES	PL1		LJD1-1819
PL/1 TRANSIENT	PL3		LJD1-1820
PROG PREP SUB	PL1,PL3	LY34-0086	
	AS1		
	AS-1AB	LY34-0125	LJD1-1830
	AS-1IN	LY34-0122	LJD1-1827
	AS-1JS	LY34-0122	LJD1-1827
	AS-1MA	LY34-0124	LJD1-1829
	AS-1TE	LY34-0123	LJD1-1828
REALTIME PROG SYS	PC1		
	PC-1CM	LY34-0105	LJD1-1824
	PC-1DM	LY34-0104	LJD1-1823
	PC-1SG	LY34-0107	LJD1-1825
	PC-1SS	LY34-0103	LJD1-1822
	PC-1UT	LY34-0107	LJD1-1825
REAL PROG SYS MACROS			LJD1-1826
STANDALONE UTIL	SC2	GY34-0071	GJD1-1813
<u>5725-SYSTEM/32</u>			
CONTROL STORE U CODE	SC-1CS	SY21-0533	SYC7-1139
DATA MANAGEMENT	SC-1DM	SY21-0535	SYC7-1139
RPGII	RG1	LY21-0538	LYC7-1331
SCHEDULAR	SC-1SH	SY21-0534	SYC7-1139
SYS. DATA AREAS HANDBOOK		SY21-0532	
SYS. SERVICES	SC1	SY21-0536	SYC7-1139
		SY21-0537	
		SY21-0551	
		SY21-0567	
UTILITIES	UT1	LY21-0539	LYC7-1332
WORD PROCESSOR	XX-1		LYC7-1354

PAGE OF : G229-2228-20
 REVISED : NOVEMBER 1977
 BY TNL : GN25-0005-4

PROGRAM TITLE PROGRAM PLM NUMBER(S) MICROFICHE NO.

5734-QS/VS1/VS2_PP

CICS/OS-STANDARD V2	XX7		LY80-0781
COBOL V3	CB1	LY28-6407	LYC7-5038
COBOL V4	CB-202	LY28-6420	LYC7-5045
COBOL V4 LIB ONLY	LM-201	LY28-6419	LYC7-5045
FORTRAN IV G1 COMP	FO-201		LYC7-5021
FORTRAN IV H EXT CMP	FO-301		LYC7-5019
FORTRAN IV LIB MOD 2	LM-301	LY28-6409	LYC7-5020
GIS/2.2	XX1	LY20-0697	
		LY20-0809	
IMS/360 V2 DATA BASE	XX-634	LY20-0630	LY80-0631
IQF/IMS	XX-635	LY20-0630	LY80-0834
		LY20-0829	
OS FORT/7	FO4		
OS PL/1 CHECKOUT CMP	PL-241	LY33-6013	LYC7-2500
		LY33-6014	
OS PL/1 OPT CMP	PL-141	LY33-6007	LYC7-2506
OS PL/1 RESIDENT LIB	LM-441	LY33-6008	LYC7-2504
OS PL/1 TRANS LIB	LM-541	LY33-6009	LYC7-2505
OS/VIDEO/370	RC-500		LYC7-5048
TSD COBOL PROMPTER	CP-101	LY28-6406	

5735

EMULATION SUPPORT	SC1	SY30-3004	
		SY30-3006	
NCP/VS	SC2		
NCP3/VTAM	SC3	SY30-3013	SJD2-4125
			SJD2-4126

5736-DOS, DOS/VS_PP

AUTO REPORT	RG-1AR	LY21-0014	
CICS/DOS ENTRY	XX-600		LY80-0724
CICS/DOS STANDARD	XX-700		LY80-0735
DOS F/ANS COBL LIB 3	LM-201		LYC7-5031
DOS FORT/7	FO1		
DOS PL/1 OPT COMP	PL-161	LY33-6010	LYC7-2503
DOS PL/1 RES LIB	LM-461	LY33-6011	LYC7-2501
DOS PL/1 TRANS LIB	LM-561	LY33-6012	LYC7-2502
DOS RPG II	RG-101	LY21-0014	LY81-0450
DOS/FULL ANS COBL V3	CB-201	LY28-6412	LYC7-5030
DOS/VIDEO/370	RC-300		LYC7-5049

<u>PROGRAM TITLE</u>	<u>PROGRAM</u>	<u>PLM NUMBER(S)</u>	<u>MICROFICHE NO.</u>
<u>5740-PP</u>			
CICS/OS/VS	XX-100	LY20-8006	LY80-8008
DASDR	UT-1	LY20-8049	LJB6-0002
GIS/VS	XX-700		
IMS/VS	XX-210	LY20-8004	LJB6-0004
		LY20-8005	LY80-8018
		LY20-8041	LY80-8016
		LY20-8050	LY80-8017
JES2 NJE	XR8	LY24-6001	LY88-0838
OS/VS COBOL COMPILER	C81	LY28-6486	LYC7-5052
OS/VS COBOL LIBRARY	LM1	LY28-6425	LYC7-5052
OS/VS SORT MERGE	SM1	LY33-8042	LYC7-0904
OS/VS1 VSPC	XR5	LY20-8036	LY80-8043
OS/VS2 VSPC	XR6	LY20-8036	LY80-8045
RACF	XXH	LY28-0730	SJB2-9503
RMF	XXM	LY28-0739	SJB2-9500
TCAM IMS	XXC	LY20-2126	LY80-2221
TCS-AF	XXD	LY20-2219	LY80-2257
TSO CMD PKG	XT6	LY28-0749	SJB2-9501
<u>5741-OS/VS1</u>			
ASSEMBLER XF	SC1-03	SY33-8041	SJD2-2034
BTAM	SC1-20	SY27-7246	SJD2-2049
CATALOG	SC1-D3		SJD2-2099
CHECKPOINT/RESTART	SC1-09	SY26-3820	SJD2-2054
COMMANDS	SC1-B8		SJD2-2022
COMMON SUPV MACROS	SC1-CN		
CONDITIONAL ASM SWTH	SC1-C5	SY33-8041	
CRJE	SC1-0A	GY30-2011	
CTS-RETAIL HOST	SC1-26		
CTS-SPPS	SC1-28	SY30-3024	SJD2-4191
DADSM	SC1-D4		SJD2-2060
DAM	SC1-D7	SY26-3836	SJD2-2062
DASD ERP	SC1-CA	SY24-5156	SJD2-2067
DIDDCS	SC1-C4		SJD2-2030
EXT PREC FLT PT SIM	SC1-CP	SY24-5155	
FETCH	SC1-C7	SY24-5155	SJD2-2055
GAM	SC1-G0	SY27-7240	SJD2-2031
		SY27-7241	
GSP	SC1-07	SY27-7242	SJD2-2032
GTF	SC1-11	SY28-0635	SJD2-2041
HMAPTELE	SC1-16	SY28-0635	SJD2-2045
HMASMP	SC1-30	SY28-0685	SJD2-2120
HMASPZAP	SC1-12	SY28-0635	SJD2-2042
HMBLIST	SC1-14	SY28-0635	SJD2-2076
HMDPRDMP	SC1-13	SY28-0635	SJD2-2043
HMDPRDMP/EDIT	SC1-18		SJD2-2106
HMSADMPP	SC1-15	SY28-0635	SJD2-2044
IBCDASDI	SC1-11	SY35-0005	SJD2-2078
IBCDMPRS	SC1-10	SY35-0005	SJD2-2077
ICAPRTBL	SC1-12	SY35-0005	SJD2-2079
IDCAMS	SC1-DK	SY35-0008	SJD2-2114

PAGE OF : G229-2228-20
 REVISED : NOVEMBER 1977
 BY TNL : GN25-0005-4

<u>PROGRAM TITLE</u>	<u>PROGRAM</u>	<u>PLM NUMBER(S)</u>	<u>MICROFICHE NO.</u>
IEBCOMPR	SC1-UK	SY35-0005	SJD2-2089
IEBCOPY	SC1-U6	SY35-0005	SJD2-2085
IEBDG	SC1-UJ	SY35-0005	SJD2-2091
IEBEDIT	SC1-U9	SY35-0005	SJD2-2102
IEBGENER	SC1-U7	SY35-0005	SJD2-2086
IEBISAM	SC1-UH	SY35-0005	SJD2-2090
IEBPTPCH	SC1-UA	SY35-0005	SJD2-2088
IEBTCRIN	SC1-UG	SY35-0005	
IEBUPDTE	SC1-U8	SY35-0005	SJD2-2087
IEHATLAS	SC1-UF	SY35-0005	SJD2-2082
IEHDASDR	SC1-U0	SY35-0005	SJD2-2080
IEHINITT	SC1-UD	SY35-0005	SJD2-2097
IEHIOSUP	SC1-U1	SY35-0005	SJD2-2081
IEHLIST	SC1-U2	SY35-0005	SJD2-2048
IEHMOVE	SC1-UC	SY35-0005	SJD2-2092
IEHPROGM	SC1-U3	SY35-0005	SJD2-2096
IEHSTATR	SC1-UE	SY35-0005	
IMCJOBQD	SC1-17	SY28-0635	
INITIATOR/DSO	SC1-B6		SJD2-2020
IMCOSJQD	SC1-19		SJD2-2129
INPUT STREAM	SC1-B1		SJD2-2015
INTERPRETER	SC1-B9		SJD2-2023
IOS	SC1-C3	SY24-5156	SJD2-2001
IPL	SC1-C1	SY24-5155	SJD2-2000
		SY24-5160	
ISAM	SC1-DB		SJD2-2063
ISSP	SC1-BK		SJD2-2122
IVP	SC1-08		
I O DEVICE ALLOCATION	SC1-B4		SJD2-2018
JAM	SC1-D9		SJD2-2064
JEC5	SC1-80		SJD2-2014
JES COMPAT INTERFACE	SC1-DB	SY26-3840	SJD2-2074
JOB LIST MGR	SC1-BJ		SJD2-2140
LINKAGE EDITOR	SC1-04	SY26-3815	SJD2-2068
LOADER	SC1-05	SY26-3814	SJD2-2069
MAPPING MACROS	SC1-01		SJD2-2003
MICR	SC1-D6		SJD2-2061
MSC TABLE CREATE	SC1-DQ	SY35-0016	SJD2-2141
MSC TRACE	SC1-DT	SY35-0014	SJD2-2144
MSS COMMUNICATOR	SC1-0P	SY35-0012	SJD2-2132
MSS DATA ANALYSIS	SC1-DS	SY28-0669	SJD2-2143
MSS SERVICES	SC1-DU	SY35-0015	SJD2-2145
MSS SPACE MANGE	SC1-DR	SY35-0012	SJD2-2142
NIP	SC1-C8	SY24-5160	SJD2-2111
DBR/EREP/RDE	SC1-CD	SY28-0669	SJD2-2160
OCR	SC1-D5		
OLTEP	SC1-06	SY28-0662	SJD2-2046
OPEN/CLOSE/EOV	SC1-D1	SY26-3839	SJD2-2058
OUTPUT STREAM CTL	SC1-B2		SJD2-2016
OVERLAY SUPERVISOR	SC1-C2	SY24-5155	SJD2-2056
PAM	SC1-D2	SY26-3840	SJD2-2059
PASSWORD PROTECT	SC1-DC	SY26-3836	
QUEUE MANAGER	SC1-B5		SJD2-2019
RES	SC1-BB	SY28-6849	SJD2-2105
RES ACCOUNT UTILITY	SC1-BC		SJD2-2107
RMS	SC1-CE	GY27-7239	SJD2-2033
RSTRT RDR/DSDR PROC	SC1-BD		
SAM	SC1-D0	SY26-3840	SJD2-2057
SCHED INITIALIZATION	SC1-BG		
SCHEDULER SMF	SC1-D0		SJD2-2009
SCHEDULER SYSGEN	SC1-S5		

<u>PROGRAM TITLE</u>	<u>PROGRAM</u>	<u>PLM NUMBER(S)</u>	<u>MICROFICHE NO.</u>
SERVICE AIDS SYSGEN	SC1-S6	SY28-0635	
SGIEH402	SC1-UX	SY35-0005	
SMF	SC1-02	SY24-5155	SJD2-2094
SSS (BASE IND SUPT)	SC1-SS	SY30-3017	SJD2-2133 SJD2-4180
STARTER SYSTEM 3330	SC1-S2		
SUPERVISOR	SC1-C5	SY24-5155	SJD2-2002
SUPERVISOR SYSGEN	SC1-S4		
SYSGEN	SC1-S1		SJD2-2128
SYSTEM LOG	SC1-BE		
SYSTEM RESTART	SC1-B3		SJD2-2017
TAPE/3851 ERP/VES	SC1-CC	SY24-5156	SJD2-2101
TCAM	SC1-21	SY30-2049	SJD2-2124
		SY30-2069	
TCAM DIRECT	SC1-21	SY30-3032	SJD2-2161
TERMINATION	SC1-B7		SJD2-2021
TOLTEP	SC1-0C	SY28-0664	SJD2-2134
UNIT RECORD ERP	SC1-CB	SY24-5156	SJD2-2010
VSAM	SC1-DE	SY26-3841	SJD2-2118
		SY35-0008	
VTAM	SC1-23	SY27-7256	SJD2-2113
		SY27-7257	
		SY27-7266	
WTP	SC1-BF		SJD2-2026
3344/3350 AP-1	SC1-31	SY26-3851	SJD2-2138
3505/3525 RDR/PCH SP	SC1-DD		SJD2-2108
3540	SC1-DN	SY24-5166	SJD2-2131
3600 HOST SUPPORT	SC1-24	SY27-7261	
3851 ERP	SC1-CI		SJD2-2139
3886 OCR	SC1-DL		SJD2-2116
3890 DOC PROCD	SC1-DF		SJD2-2115
<u>5742-05/VS2</u>			
ALLOCATION	SC1-B4		SJD2-0350
AMAPTELE	SC1-16	SY28-0643	SJD2-0470
AMASPZAP	SC1-12	SY28-0643	
AMBLIST	SC1-14	SY28-0643	SJD2-0880
AMDPRDMP	SC1-13	SY28-0643	SJD2-0450
AMDPRDMP/EDIT	SC1-18	SY28-0643	
AMDSADMP	SC1-15	SY28-0643	SJD2-0460
ASSEMBLER XF	SC1-03	SY33-8041	SJD2-0890
BLDL LIST	SC1-CT		
BTAM	SC1-20	SY27-7246	SJD2-0560
CATALOG	SC1-D3		SJD2-0080
CHECKPOINT/RESTART	SC1-09	SY26-3820	SJD2-0820
COMMANDS	SC1-B8		SJD2-0390
COMMON SUPV MACROS	SC1-CN		
CONDITIONAL ASM SWTH	SC1-CS	SY33-8041	
DADSM	SC1-D4		SJD2-0840
DAM	SC1-D7		SJD2-0690
DASD ERP	SC1-CA	SY26-3823	SJD2-0710
DIDOCs	SC1-C4		SJD2-0300
EXT PREC FLT PT SIM	SC1-CP		SJD2-0140
EXTENDED SERVICE RTR	SC1-CF		
FETCH	SC1-C7	SY27-7244	SJD2-0650
GAM	SC1-G0	SY27-7240	SJD2-0290
		SY27-7241	
GSP	SC1-07	SY27-7242	SJD2-0280
GTF	SC1-11	SY28-0643	SJD2-0430
HMASMP	SC1-30	SY28-0685	GJD1-1100

PAGE OF : G229-2228-2C
 REVISED : NOVEMBER 1977
 BY TNL : GN25-0005-4

PROGRAM TITLE	PROGRAM	PLM NUMBER(S)	MICROFICHE NO.
IBCDASDI	SC1-I1	SY35-0005	
IBCDMPRS	SC1-I0	SY35-0005	
ICAPRTBL	SC1-I2	SY35-0005	
IDCAMS	SC1-DK	SY35-0008	SJD2-1220
IEBCOMPR	SC1-UK	SY35-0005	SJD2-0210
IEBCOPY	SC1-U6	SY35-0005	SJD2-0170
IEBOG	SC1-UJ	SY35-0005	SJD2-0230
IEBEDIT	SC1-U9	SY35-0005	SJD2-0050
IEBGENER	SC1-U7	SY35-0005	
IEBISAM	SC1-UH	SY35-0005	
IEBPTPCH	SC1-UA	SY35-0005	SJD2-0200
IEBTGRIN	SC1-UG	SY35-0005	SJD2-0580
IEBUPDTE	SC1-U8	SY35-0005	SJD2-0190
IEHATLAS	SC1-UF	SY35-0005	SJD2-0780
IEHDASDR	SC1-U0	SY35-0005	SJD2-0770
IEHINITT	SC1-UD	SY35-0005	SJD2-0020
IEHLIST	SC1-U2	SY35-0005	
IEHMOVE	SC1-UC	SY35-0005	SJD2-0160
IEHPRGM	SC1-U3	SY35-0005	SJD2-0070
IEHSTATR	SC1-UE	SY35-0005	SJD2-0030
INITIATOR	SC1-B6		SJD2-0370
INTERPRETER	SC1-B9		SJD2-0400
IOS	SC1-C3	SY26-3823	SJD2-0700
IPL	SC1-C1		
ISAM	SC1-D8		SJD2-0810
IVP	SC1-08		
LINK LOADGO PROMPTER	SC1-T5	SY28-0651 SY28-0652 SY28-0650	SJD2-0850
LINKAGE EDITOR	SC1-04	SY26-3815	SJD2-0860
LOADER	SC1-05	SY26-3814	SJD2-0870
MAPPING MACROS	SC1-01		
MICR	SC1-D6		SJD2-0680
OBR/EREP/RDE	SC1-CD		SJD2-0420
OCR	SC1-D5		SJD2-0600
QLTEP	SC1-06		SJD2-0550
OPEN/CLOSE/EOV	SC1-D1		SJD2-0830
OVERLAY SUPERVISOR	SC1-C2	SY27-7244	SJD2-0640
PAM	SC1-D2		SJD2-0670
PASSWORD PROTECT	SC1-DC		
QUEUE MANAGER	SC1-B5		SJD2-0360
REL LEVEL ID MACROS	SC1-0B		
RMS	SC1-CE	SY27-7239	SJD2-0270
SAM	SC1-D0	SY26-3840	SJD2-0660
SCHEDULER SMF	SC1-00		
SCHEDULER SYSGEN	SC1-S5		
SERVICE AIDS SYSGEN	SC1-S6		
SGIEH402	SC1-UX	SY35-0005	
SMF	SC1-02		SJD2-0010
STARTER SYSTEM 2314	SC1-S3		
STARTER SYSTEM 3330	SC1-S2		
SUPERVISOR	SC1-C5	SY27-7244	SJD2-0260
SYSGEN	SC1-S1	SY28-0643	
SYSDOUT WRITER	SC1-B2		SJD2-0790
SYSTEM RESTART	SC1-B3		SJD2-0330
TAPE ERP/VES	SC1-CC	SY26-3823	SJD2-0040
TCAM	SC1-21	SY30-2040 SY30-2049	SJD2-0570
TCAM DIRECT	SC1-21	SY30-3032	SJD2-7200
TERMINATION	SC1-B7		SJD2-0380
TSO DATA MANAGEMENT	SC1-T3	SY30-2049 SY28-0651 SY28-0650	SJD2-0740 SJD2-7205

<u>PROGRAM TITLE</u>	<u>PROGRAM</u>	<u>PLM NUMBER(S)</u>	<u>MICROFICHE NO</u>
TSD EDIT	SC1-T0	SY28-0651 SY33-8548 SY28-0653 SY28-0659 SY28-0650	SJD2-0240
TSD SCHEDULER	SC1-T4	SY28-0650 SY28-0653 SY28-0651 SY28-0659	SJD2-0410
TSD SUPERVISOR	SC1-T7	SY28-0649 SY28-0651 SY28-0650	SJD2-0320
TSD TCAM SUBROUTINE	SC1-T8	SY28-0651 SY28-0650	SJD2-0730
TSD TEST	SC1-T1	SY30-2049 SY28-0651 SY35-0004 SY28-0650	SJD2-0130
TSD TRACE	SC1-T9	SY28-0649 SY28-0651 SY28-0650	
TSD UTILITIES	SC1-T2	SY28-0651 SY28-0652 SY28-0650	SJD2-0120
UNIT RECORD ERP	SC1-CB	SY26-3823	SJD2-0720
VSAM	SC1-DE		SJD2-1220
VTAM	SC1-23		SJB1-0461
3505/3525 RDR/PCH SP	SC1-DD	SY26-3832	SJD2-0590
3735 MACROS/UTILITY	SC1-22		
<u>5744-QS/VS1, QS/VS2, DOS</u>			
BATCH TRANSFER PROGRAM	CG1,CG2,CH1	SY33-8901	SYC7-1702 SYC7-1703 SYC7-1704
DISK COPY PROGRAM	BJ1,BL1		
DISK INTEL SYSTEM	BK1	GY34-0019	GJD1-1795
DOS EMULATOR	AS1	SY33-7015	SYC7-2101
OS/VS ASM/7	AB1		GJD1-1796 GJD1-1797
OS/VS FORMAT/7	AD1		GJD1-1796 GJD1-1797
OS/VS LINK/7	AC1	GY34-0008	GJD1-1796 GJD1-1797
OS/VS MACLIB/R	AA1	GY34-0010 GY34-0012 GY34-0018	GJD1-1790 GJD1-1794
SYSTEM SUPPORT PROGRAM	AN1	SY30-3004 SY30-3006	GJD2-4118
1285/1287/1288 D M	AE1		
1401 EMULATOR	AH1	SY33-7016	
1410 EMULATOR	AG1		
3735 MACROS & UTIL	AZ1		
3790 HOST SUPPORT	BZ1,BZ2	SY27-7264	SJB1-0022

PAGE OF : G229-2228-20
 REVISED : NOVEMBER 1977
 BY TNL : GN25-0005-4

PROGRAM TITLE	PROGRAM	PLM NUMBER(S)	MICROFICHE NO.
5745-DQS/V5			
ASSEMBLER PHK	SC-ASM	SY33-8567	SYC7-1934
ATTENTION ROUTINES	SC-AIT	SY33-8553	SYC7-1932
BTAM	SC-BTM	SY27-7251	SYC7-1935
CHECKPOINT/RESTART	SC-CKR	SY33-8559	SYC7-1936
CTS-RETAIL HOST	SC-RTL		
CTS-SPPS	SC-SPP	SY30-3024	SJD2-4190
COMP I/O MODULES	SC-IOM	SY33-8560	SYC7-1944
DIR ACC METHOD	SC-DAM	SY33-8561	SYC7-1937
DISK EREP	SC-DKE	SY33-8552	SYC7-1938
DISKETTE IOCS	SC-DIO	SY33-8560	SYC7-1966
DISP OPER CONSOLE	SC-DOC	SY33-8553	SYC7-1939
		SY33-8560	
DISTRIBUTION PROGRAM	SC-DIS		SYC7-1964
EREP	SC-ERP	SY33-8554	SYC7-1942
INDEX SEQ FILE MGMT	SC-ISM	SY33-8561	SYC7-1947
IOCS/DEV IND I/O	SC-IOX	SY33-8560	SYC7-1945
		SY33-8552	
IPL BUFFER LOAD	SC-IPL	SY33-8555	SYC7-1946
JOB CONTROL	SC-JCL	SY33-8555	SYC7-1950
LIB, SERV & MAINT	SC-LBR	SY33-8557	SYC7-1949
LINKAGE EDITOR	SC-LNK	SY33-8556	SYC7-1950
MAG TAPE IOCS	SC-TAP	SY33-8560	SYC7-1960
MAINTAIN SYS HIST	SC-UTS	SY33-8558	SYC7-0451
MCR IOCS	SC-MCR	SY33-8560	SYC7-1951
MOD 20 EMULATOR	SC-E20	SY33-8575	SYC7-1943
OCR IOCS	SC-OCR	SY33-8560	SYC7-1952
OLTEP	SC-OLT	SY33-8568	SYC7-1953
PAPER TAPE IOCS	SC-PTP	SY33-8560	SYC7-1955
PD AIDS	SC-PDA	SY33-8554	SYC7-1954
POWER	SC-PWR	SY33-8570	SYC7-1976
		SY33-8572	
		SY33-8576	
		SY33-8577	
		GC33-5405	
QTAM	SC-QTM	SY27-7249	SYC7-1957
RMSR	SC-RMS	SY33-8552	SYC7-1958
SEQUENT DISK I/O	SC-DSK	SY33-8560	SYC7-1940
SSS (BASE IND SUPT)	SC-SSS	SY30-3017	SYC7-1970
SUPERVISOR	SC-SUP	SY33-8551	SYC7-1959
SYSTEM UTILITIES	SC-UTL	SY33-8558	SYC7-1962
TAPE EREP	SC-TPE	SY33-8552	SYC7-1961
TOLTEP	SC-TLT	SY28-0664	SYC7-1969
VSAM	SC-VSM	SY33-8562	SYC7-1963
3344/3350 AP-1	SC-APC	SY26-3852	SYC7-0450
VSAM SERVICE PROG	SC-AMS	SY33-8564	SYC7-1933
VTAM	SC-VTM	SY27-7256	SYC7-1968
		SY27-7262	SJD2-4122
		SY27-7263	
		SY27-7265	
		SY27-7270	
3600 RSS HOST SUPT	SC-124	SY27-7261	
1401/1410 EMULATOR	SC-EML	SY33-8573	SYC7-1941
		SY33-8574	SYC7-2107
5746 DQS/V5_PP			
ATTENTION ROUTINES	E2-AIT	LY33-9063	LYC7-0453
		LY33-9064	
DISP OPER CONSOLE	E2-DOC	LY33-9064	LYC7-0454
IPL BUFFER LOAD	E2-IPL	LY33-9066	LYC7-0455
JOB CONTROL	E2-JCL	LY33-9066	LYC7-0456

<u>PROGRAM TITLE</u>	<u>PROGRAM</u>	<u>PLM NUMBER(S)</u>	<u>MICROFICHE NO.</u>
LIBRARIAN	E2-LBR	LY33-9068	LYC7-0457
LINKAGE EDITOR	E2-LNK	LY33-9067	LYC7-0458
PD AIDS	E2-PDA	LY33-9065	LYC7-0459
SUPERVISOR	E2-SUP	LY33-9063	LYC7-0460
CICS DOS/V5 EXT M	XXB		LYB0-2218
CICS/DOS/V5	XX3	LY20-8007	
DL/1 DOS	XX1	LY12-5016	LYB0-0839
DL/1 ENTRY	XX7	LY12-5017	LYA2-5213
DOS/V5 FULL CBL/LIB	CB1	LY28-6423	LYC7-5050
DOS/V5 FULL LIB	LM4	LY28-6424	LYC7-5050
DOS/V5 SORT/MERGE	SM1	LY33-8038	LYC7-0903
			LYC7-0905
DOS/V5 VSPC	XR3	LY20-8039	LYB0-8046
FOR 4 LIB DOS 3330	LM3	GY28-6394	LYC7-5044
<u>5747 DOS/V5 SYS/7</u>			
BATCH TRANSFER PROG	BW1	SY33-8900	SYC7-1701
DOS/V5 ASM/7	AB1	GY34-0007	GJD1-1787
DOS/V5 FORMAT/7	AD1	GY34-0007	GJD1-1787
DOS/V5 LINK/7	AC1	GY34-0009	GJD1-1787
DOS/V5 MACLIB/R	AE1	GY34-0010	GJD1-1790
		GY34-0012	GJD1-1794
		GY34-0018	
3600 HOST SUPPORT	BR1	SY27-7261	
3705 DOS/V5 ASSEMBLER	AG1	SY30-3004	SJD2-4132
		SY30-3006	
3735 MACROS & UTIL	AZ1		
3790 HOST SUPPORT	BQ1	SY27-7264	GJ81-0001
<u>5748-PP</u>			
VS APL	AP1	LY20-8032	LYB0-8040
VS/BASIC	XX1	LY28-6422	LYC7-5051
VSPC FORTRAN	FQ2	LY20-8031	LYB0-8044
<u>5749-VH/370</u>			
ASSEMBLER	SC-103	SY33-8041	SYB0-0901
CMS	DMS		SYB0-0901
CP	DMK	SY20-0882	SYB0-0900
		SY25-7701	
IPCS	DMH-00		SYC0-9001
RSCS	DMT	SY20-0883	SYC0-9000
<u>5752-OS/V52 RELEASE 2 AND ABOVE</u>			
ACCESS METHOD SERVICE	SC1-DK	SY35-0010	SJD2-4710
ALLOCATION	SC1-B4		SJD2-4260
AMAPTELE	SC1-16	SY28-0643	
AMASPZAP	SC1-12	SY28-0643	SJD2-5230
AMBLIST	SC1-14	SY28-0643	SJD2-5250
AMDPRDMP	SC1-13	SY28-0643	SJD2-5240
AMDPRDMP/EDIT	SC1-18	SY28-0643	SJD2-5280
AMDSADMP	SC1-15	SY28-0643	SJD2-5260
ASSEMBLER XF	SC1-03	SY33-8041	SJD2-5150
AUX STOR MANAGER	SC1-CW		SJD2-4490
BLOCK PROCESSOR	SC1-DA	SY26-3825	SJD2-4620
BTAM	SC1-20	SY27-7246	SJD2-5290
CATALOG CNTRLR 3	SC1-DH	SY35-0011	SJD2-4690
CHECKPOINT/RESTART	SC1-09	SY26-3820	SJD2-5200

PAGE OF : G229-2228-20
 REVISED : NOVEMBER 1977
 BY TNL : GN25-0005-4

<u>PROGRAM TITLE</u>	<u>PROGRAM</u>	<u>PLM NUMBER(S)</u>	<u>MICROFICHE NO.</u>
COMM TASK	SC1-CK		SJD2-4410
COND ASM SWITCH	SC1-CS		
CONTENTS SUPERVISOR	SC1-CJ		SJD2-4400
CONVERTER/INTERPRETER	SC1-B9		SJD2-4310
CTS-RETAIL HOST	SC1-26		
CTS-SPPS	SC1-28	SY30-3024	
DADSM	SC1-04	SY26-3828	SJD2-4770
DAM	SC1-07		SJD2-4800
DASD ERP	SC1-CA	SY26-3823	SJD2-4330
DIDDCS	SC1-C4		SJD2-4560
EXCP	SC1-C6	SY26-3823	SJD2-4580
EXT PREC FLT PNT	SC1-CP		
EXTENDED SVC ROUTER	SC1-CF		
EXTERNAL WRITER	SC1-B2	SY28-0622	SJD2-4240
FETCH	SC1-C7		SJD2-4590
GAM	SC1-G0	SY27-7241	SJD2-4820
		SY27-7260	
GSP	SC1-07	SY27-7242	
GTF	SC1-11	SY28-0643	SJD2-5220
HMASMP	SC1-30	SY28-0685	SJD2-5330
IBCDASDI	SC1-11	SY35-0005	SJD2-4840
IBCDMPRS	SC1-10	SY35-0005	SJD2-4830
ICAPRTBL	SC1-12	SY35-0005	
IEABLD00	SC1-CT		
IEBCMPR	SC1-UK	SY35-0005	
IEBCOPY	SC1-U6	SY35-0005	
IEBDG	SC1-UJ	SY35-0005	SJD2-5000
IEBEDIT	SC1-U9	SY35-0005	SJD2-5090
IEBGENER	SC1-U7	SY35-0005	
IEBISAM	SC1-UH	SY35-0005	SJD2-4990
IEBPTPCH	SC1-UA	SY35-0005	
IEBTCRIN	SC1-UG	SY35-0005	
IEBUPDTE	SC1-U8	SY35-0005	SJD2-5080
IEHATLAS	SC1-UF	SY35-0005	SJD2-4970
IEHDASDR	SC1-U0	SY35-0005	SJD2-5030
IEHINIIT	SC1-UD	SY35-0005	SJD2-4950
IEHLIST	SC1-U2	SY35-0005	SJD2-5040
IEHMOVE	SC1-UC	SY35-0005	SJD2-4940
IEHPRGM	SC1-U3	SY35-0005	SJD2-5050
IEHSTATR	SC1-UE	SY35-0005	
IEHUCAT	SC1-UY	SY35-0005	
INITIATOR	SC1-B6		SJD2-4280
IOS	SC1-C3	SY26-3823	SJD2-4550
IPL	SC1-C9	SY28-0623	
ISAM	SC1-08	SY26-3833	SJD2-4810
IVP	SC1-08		
JES 2	SC1-BH	SY28-0622	SJD2-4230
		SY24-6000	
		SY28-0612	
JES 3	SC1-BA		
LINK LOADGO PROMPTER	SC1-T5		
LINKAGE EDITOR	SC1-04	SY26-3815	SJD2-5160
LOADER	SC1-05	SY26-3814	
M S COMMANDS	SC1-B8		SJD2-4790
MAPPING/SUPVR MACROS	SC1-01		SJD2-5130
MICR	SC1-06	GY21-0012	SJD2-4790
MF/1	SC1-CQ		SJD2-4450

<u>PROGRAM TITLE</u>	<u>PROGRAM</u>	<u>PLM NUMBER(S)</u>	<u>MICROFICHE NO.</u>
M P RECONFIGURATION	SC1-CZ		SJD2-4520
MSC TABLE CREATE	SC1-DQ		SJD2-5440
MSC TRACE	SC1-DT	SY35-0014	SJD2-5400
MSS COMMUNICATOR	SC1-DP	SY35-0013	SJD2-5370
MSS DATA ANALYSIS	SC1-DS	SY28-0678	SJD2-5390
MSS SERVICES	SC1-DU	SY35-0015	SJD2-5410
MSS SPACE MANGE	SC1-DR	SY35-0012	SJD2-5380
NIP	SC1-C8	SY28-0623	SJD2-4600
D/C/EOV	SC1-D1	SY26-3827	SJD2-4740
OBR/EREP/RDE	SC1-CD	SY28-0678	SJD2-4350
OCR	SC1-D5		SJD2-4780
QLTEP	SC1-06		SJD2-5180
OVERLAY SUPERVISOR	SC1-C2		
PAM	SC1-D2	SY26-3828	SJD2-4750
PASSWORD PROTECT	SC1-DC	SY26-3827	SJD2-4640
POWER WARNING FEATURE	SC1-DE		
RADIX PARTITION TREE	SC1-CY		
REAL STOR MANAGER	SC1-CR		SJD2-4460
RECOVERY TERMINATION	SC1-CM		SJD2-4430
REGION CONTROL TASK	SC1-CU		SJD2-4470
RMS	SC1-CE	SY27-7250	SJD2-4360
SAM	SC1-D0		SJD2-4730
SAM SUBSYSTEM	SC1-DB		SJD2-4630
SCHEDULER RESTART	SC1-B3		SJD2-4250
SCHEDULER SYSGEN	SC1-S5		
S SYSGEN	SC1-S6		
SGIEH40Z	SC1-UX	SERVICE AID SY35-0005	
SMF	SC1-02	SY28-0626	SJD2-5140
SSS	SC1-SS	SY30-3017	SJD2-2133
SMF SCHEDULER	SC1-00	SY28-0626	SJD2-5120
SUPERVISOR CONTROL	SC1-C5		SJD2-4570
SUPERVISOR SYSGEN	SC1-S4		
SVC 109	SC1-CG		
SWA MANAGER	SC1-B5		SJD2-4270
SYSGEN	SC1-S1		
SYSTEM RESOURCE MGR	SC1-CX		SJD2-4500
TAPE ERP/VES	SC1-GC	SY26-3823	SJD2-4340
TASK MANAGER	SC1-CL		SJD2-4420
TCAM	SC1-21	SY30-2040	SJD2-5300
TCAM DIRECT	SC1-21	SY30-3032	
TIMER SUPERVISOR	SC1-CV		SJD2-4480
TOLTEP	SC1-0C	SY28-0664	
TSO EDIT	SC1-Y0	SY33-8548	SJD2-4860
TSO SCHEDULER	SC1-T4	SY28-0626	SJD2-4900
TSO TCAM SUBROUTINES	SC1-T8		SJD2-4920
TSO TEST	SC1-T1	SY35-0004	SJD2-4870
TSO TIOC	SC1-T3		SJD2-4890
TSO UTILITIES	SC1-T2		SJD2-4880
W P F00	SC1-CB	SY26-3823	SJD2-4330

PAGE OF : G229-2228-20
 REVISED : NOVEMBER 1977
 BY TNL : GN25-0005-4

<u>PROGRAM TITLE</u>	<u>PROGRAM</u>	<u>PLM NUMBER(S)</u>	<u>MICROFICHE NO.</u>
VBP	SC1-DG	SY26-3834	SJD2-4680
VIRT STOR MANGR	SC1-CH		SJD2-4390
VSAM & VSAM CATALOG	SC1-DE		SJD2-4660
VTAM	SC1-23	SY27-7256 SY27-7267 SY27-7272 SY28-0621 SY26-3834	SJD2-5320
WINDOW INTERCEPT	SC1-DJ		
2314 STARTER	SC1-S3		
3330 STARTER	SC1-S2		
3340/3350 AP-1	SC1-31		SJ86-6002
3505/3525 RDR/PCH	SC1-DD		SJD2-4650
3540	SC1-DN		SJD2-5360
3600 HOST SUPPORT	SC1-24	SY27-7261	SJD2-5430
3886 OCR	SC1-DL		
3890 DOCUMNT PROC	SC1-DF		SJD2-4670
<u>5799-PSHRPQ-RPQ</u>			
EMUL B100/200/300	AAC		
EMULATOR H120/200	AAB		
FILM RDR/RECORDER	WAA		
FORTAN H EXT PLUS	AAW		LYC7-5042
HASP NETWORKING	ATC	LY20-2340	
MLTA TERM ADAPT	WFK	SY21-0527	
PRPQ	AAR		
PRPQ	AAT		
PSHRPQ	WAF		
S/3 MOD6 1017 IOCS	WDF		
S/3 MOD6 1018 IOCS	WDL		
S/3 M10 BSCA MODIF	WHG		
S/3 M10 C 1017 IOCS	WAD		
S/3 M10 C 1018 IOCS	WAM		
S/3 M10 C 2501 ATT	WCE		
S/3 M10 D 1017 IOCS	WAE		
S/3 M10 D 1018 IOCS	WAN		
S/3 M10 D MLTA IOCS	WAU		SYC7-1111
S/3 M10 D 2501 ATT	WCF		
S/3 M10 D 2956 ATT	WGX		
S/3 M10 INT. TIMER	WGY		
S/3 M10 1017/1442	WOP		
S/3 M10 1018/1441	WFD		
S/3 M10 2ND 1403 ATT	WHL		
S/3 M10 2793/2797	WDT		
S/3 M12 MLTA IOCS	WKH	SY21-0527	SYC7-1137
S/3 M15 D MLTA IOCS	WLD		SYC7-1143
S/3 M15 MLTA IOCS	WFK	SY21-0527	SYC7-1127
S/3 M15 1017 IOCS	WHP		
S/3 M15 1018 IOCS	WHI		
S/7 CH ATT-OS/DOS	WCB	SY34-0517	
S/7 TPMM BSC	WFG	SY34-0542	
S/7 3340 ATT	WJH	SY09-1200	GJD1-1804
S/7 3340 ATT	WJJ	SY09-1200	GJD1-1804
S/7 3340 ATT	WJK	SY09-1200	GJD1-1804
S/7 3340 ATT	WJX	SY09-1200	GJD1-1804
S/7 3340 ATT	WJY	SY09-1200	GJD1-1804
VM/370 NETWORKING	ATA	LY20-2342	
VM/370 RESOURCE MGT.	ARQ	LY20-1996	
2740/2968 A/V CTL PK	WAB		
3350/3330 MOD II	ARG	LY20-8047	LJ86-0001
3705 ASC II TRANS	AFZ		

IBM Technical Newsletter

This TNL: GN25-0005-4
Date: November 1977
Base Publication: G229-2228-20

Previous TNLs:
Section 1: None (Previous TNLs
Obsolete)
Section 2: None

IBM Field Engineering
Programming System
General Information

This Technical Newsletter provides replacement pages for Section 1 of the subject publication.

Remove pages	Add new pages
iii	iii
1-1 through 1-57	1-1 through 1-56

Please file this cover letter at the back of the publication to provide a record of changes.

IBM Technical Newsletter

This TNL: GN25-0005-3
Date: October 1977
Base Publication: G229-2228-20

Previous TNLs:
Section 1: (None) Previous TNLs
Obsolete
Section 2: None

IBM Field Engineering
Programming System
General Information

This Technical Newsletter provides replacement pages for Section 1 of the subject publication.

Remove pages

Add new pages

1-1 through 1-57

1-1 through 1-57

Please file this cover letter at the back of the publication to provide a record of changes.

WHEN COMPLETING AR REPORTS RELATED TO PROGRAMS AND PROGRAMMING SYSTEMS, THE CORRESPONDING FE SERVICE NUMBER MUST BE NOTED. WHEN WRITING AN INCOMPLETE AR (2 IN 'CIA' BLOCK) RELATING TO PROGRAMMING SYSTEMS, THE SYSTEM BASE NUMBER MAY BE USED. SYSTEM BASE FE SERVICE NUMBERS ARE AS FOLLOWS:

360D - 009	360N - 002	360P - 004
360S - 001	370N - 042	OS/VSI - 152
OS/SVS - 153	VM/370 - 154	OS/HVS - 155
DOS/VS - 156		

THE FOLLOWING FIELD ENGINEERING FIELD SUPPORT LOCATIONS ARE RESPONSIBLE FOR SUPPORTING CLASS 'A' AND 'SCP' PROGRAMS AND THE FESER AS INDICATED:

SUPP. CODE	LOCATION	SUPP. CODE	LOCATION
01	ENDICOTT	27	BOCA RATON
02	POUGHKEEPSIE	62	HURSLEY
03	KINGSTON	63	LA GAUDE
10	ROCHESTER	64	BOEBLINGEN
13	SANTA TERESA	65	NORDIC LABS
23	RALEIGH	66	UITHOORN

*FOR FESER MAILING ADDRESSES, SEE PAGE 1-40

THE FOLLOWING DP/GSD/SDD SUPPORT LOCATIONS ARE RESPONSIBLE FOR SUPPORTING CLASS 'B' PROGRAMS AS INDICATED:

SUPP. CODE	LOCATION	SUPP. CODE	LOCATION
BR	BOCA RATON	PR	PARIS
CH	CHICAGO	RO	ROCHESTER
CR	CROYDON	ST	STUTTGART
LA	LOS ANGELES	TO	TOKYO
MP	MENLO PARK	WA	WASHINGTON
PA	PALO ALTO	WP	WHITE PLAINS
PK	POUGHKEEPSIE		

IMPORTANT

UNLESS OTHERWISE INDICATED IN THE FOLLOWING LIST, THE ORIGINAL AND GREEN COPIES OF THE APAR FORM SHOULD BE SENT TO THE ADDRESS SPECIFIED. RETAIN THE PINK COPY FOR YOUR FILES. THE BLUE COPY IS EXTRA AND CAN BE USED AS A WORKSHEET.

 *WHEN USING A PREPAID MAILING LABEL, BE SURE TO INCLUDE A RETURN ADDRESS ON THE OUTSIDE OF EACH PACKAGE. FREQUENTLY, PACKAGES ARE RECEIVED WITHOUT POSTMARK AND UNLESS THERE IS A RETURN ADDRESS, IBM WILL BE CHARGED THE MAXIMUM POSTAGE RATE.

SOME PREPAID MAILING LABELS HAVE A DETACHABLE PORTION WHICH **MUST** BE FILLED OUT AND PLACED IN THE LOWER LEFT HAND CORNER OF THE PARCEL PRIOR TO MAILING. THIS INFORMATION WILL BE USED TO EXPEDITE DELIVERY OF THE APAR TO THE PROPER PROCESSING GROUP.

PROVIDE **BOTH** THE PRE-ASSIGNED APAR NUMBER AND THE ASSIGNED NUMBER (IF KNOWN) AT THE TIME OF SUBMISSION. PROVIDE THE ASSIGNED APAR NUMBER WHENEVER SUBMITTING ADDITIONAL INFORMATION.

INSTRUCTIONS FOR SUBMISSION OF APARS TO EUROPEAN CHANGE TEAMS:

FOR NORMAL APAR SHIPMENTS, THAT IS WHEN THE EXPENSE OF HAVING IT EXPEDITED IS NOT WARRANTED, TO APAR ADDRESSES E,F,G,H,S AND CB THROUGH THE WORLD TRADE DISTRIBUTION CENTER FACILITIES, THE FOLLOWING PROCEDURE SHOULD BE FOLLOWED:

1. THE NORMAL APAR PRE-SCREENING PROCESS WILL BE FOLLOWED.
2. THE APAR MATERIAL MUST BE CONTAINED IN THE APAR MAILER BOX (FORM S229-2147) OR A SIMILAR CONTAINER - IT MUST BE BOXED. IF THE APAR MAILER BOX IS NOT USED, THE DIMENSIONS OF THE BOX SHIPPED (LENGTH, WIDTH, AND HEIGHT) MUST BE MARKED ON THE DESCRIPTIVE PORTION OF THE LABEL.
3. THE NEW PREPAID LABEL (FORM S229-3225) MUST BE COMPLETELY FILLED OUT AND AFFIXED TO THE APAR MAILER BOX. IF THE LABEL IS NOT AVAILABLE, THE ADDRESS AND DESCRIPTIVE INFORMATION MUST BE CLEARLY MARKED ON THE BOX.

RETURN ADDRESS:

IBM B/O_____
 _____ (STREET)
 _____ (CITY,STATE,ZIP)

IBM WORLD TRADE CORPORATION
 WORLD TRADE DISTRIBUTION CENTER,BLDG. 306
 ATTN: RECEIVING DEPT.
 EAST FISHKILL FACILITY, ROUTE 52
 HOPEWELL JUNCTION, N.Y. 12533

4. THE FOLLOWING GUIDE IS TO BE USED WHEN COMPLETING THE DESCRIPTIVE PORTION OF THE LABEL:

	P/C		Q	U/Z/Y	V
PRE AP_ _ _ _	32	TAPES	-	___	___
DATE SHIPPED_/_/_/_	71	CARDS	-	___	___
SHIP TO CODE_ _	71	PRINTED MAT.	-	___	___
PROG. ID_ _ _ _ _	32	DISK	-	___	___
	16	PTF	-	___	___
GROSS WEIGHT_____					___

1. PRE AP_ _ _ _; FILL IN THE BLANK WITH THE APAR PRE-ASSIGNED SERIAL NUMBER FROM THE APAR FORM BEING SUBMITTED.
2. DATE SHIPPED_/_/_/_; SUPPLY THE DATE THE PACKAGE IS MAILED BY THE PSR IN THE FORM Y/MM/DD.

3. SHIP TO CODE_ _ _; FILL IN THE SHIP TO CODE AS DESCRIBED BELOW:
 A) USING THE PSGIM, DETERMINE THE CHANGE TEAM CODE USED IN THE PREVIOUS APAR MAILING ADDRESS FOR THE COMPONENT.
 B) OBTAIN THE SHIP TO CODE FROM THE CHART BELOW:

MAIL ADDRESS	SHIP TO CODE
E	5U6
F	2F1
G	1G1
H	4N2
S	5S5
CB	5U6

- C) WRITE THE THREE DIGIT SHIP TO CODE IN THE SPACE PROVIDED ON THE SHIPPING LABEL.
 4. PROG. ID _ _ _ _ _ _ _ _ _ _; COMPLETE THIS FIELD BY INCLUDING THE PROG. ID OF THE COMPONENT BEING APARED.
 5. GROSS WEIGHT _____; ENTER THE WEIGHT OF THE PACKAGE IN POUNDS.
 6.

	Q	U/V	V
TAPES	_____	_____	_____
CARDS	_____	_____	_____
PRINTED MAT.	_____	_____	_____
DISK	_____	_____	_____
PTF	_____	_____	_____

UNDER THE COLUMN LABELED Q, INDICATE THE QUANTITY OF EACH TYPE OF SUPPORTING DOCUMENTATION CONTAINED IN THE PACKAGE. IF THERE ARE NO ITEMS OF A PARTICULAR TYPE LISTED, THEN MARK THAT ROW WITH A ZERO IN EACH COLUMN.

UNDER THE COLUMN LABELED U/V, INDICATE THE UNIT VALUE OF EACH ITEM INCLUDED OF THIS TYPE. A VALUE MUST BE INCLUDED FOR EACH TYPE OF MATERIAL BEING SENT. ZERO MAY NOT BE USED IN THIS COLUMN, OR IN THE V COLUMN, UNLESS THE Q COLUMN FOR THAT TYPE IS ALSO ZERO.

THE FOLLOWING VALUES ARE TO BE USED IN THIS COLUMN:

	UNIT/VALUE
FOR TAPES: 2400 FT REEL	8
1200 FT REEL	6
SMALLER REEL	3
FOR CARDS:	1 FOR EACH DECK
PRINTED MATERIAL:	1 FOR EACH SEPARATE LISTING
FOR DISK PACKS: 1316	360
2316	525
2315	90
3336 MOD I	775
3336 MOD II	1150
3348 35 MEG	1600
3348 70 MEG	2200
3348 FIXED HEAD	4400
5400	175
FOR PTFs:	1 FOR EACH DECK

UNDER THE COLUMN LABELED V, INDICATE THE PRODUCT OF THE VALUE CONTAINED IN COLUMN Q MULTIPLIED BY THE VALUE CONTAINED IN COLUMN U/V.

*FOR CRITICAL OR POTENTIALLY CRITICAL APARS, THAT IS FOR *
*EXPEDITED SHIPMENTS TO APAR ADDRESSES E,F,G,H,S,AS AND CB *
*THROUGH THE WORLD TRADE DISTRIBUTION CENTER FACILITIES, THE *
*FOLLOWING PROCEDURE SHOULD BE FOLLOWED: *

1. THE NORMAL APAR PRE-SCREENING PROCESS WILL BE FOLLOWED.
2. THE APAR MATERIAL MUST BE CONTAINED IN THE APAR MAILER BOX (FORM S229-2147) OR A SIMILAR CONTAINER - IT MUST BE BOXED. IF THE APAR MAILER BOX IS NOT USED, THE DIMENSIONS OF THE BOX SHIPPED (LENGTH, WIDTH, AND HEIGHT) MUST BE MARKED ON THE DESCRIPTIVE PORTION OF THE LABEL.
3. THE DESCRIPTIVE PORTION OF THE NEW LABEL (FORM S229-3225) MUST BE COMPLETELY FILLED OUT, REFERENCE INSTRUCTIONS UNDER NORMAL APAR SHIPMENTS, AND AFFIXED TO THE APAR MAILER BOX (FORM S229-2147) AFTER THE ADDRESS PORTION HAS BEEN DETACHED AND DISCARDED. IF THE LABEL IS NOT AVAILABLE, THE ADDRESS AND DESCRIPTIVE INFORMATION MUST BE CLEARLY MARKED ON THE BOX.
4. LOCAL ARRANGEMENTS MUST BE MADE TO TRANSPORT THE APAR TO:

IBM WORLD TRADE CORPORATION
C/O UNIVERSAL TRANSCONTINENTAL CORPORATION
147-17 NEW YORK BLVD.
JAMAICA, NEW YORK 11434

IF THE APAR IS SHIPPED VIA AN AIRLINE TO JFK, THIS MAY BE BEST HANDLED BY UTILIZING ONE OF THE SPECIAL PROGRAMS THAT MOST AIRLINES HAVE FOR EXPEDITING THE SHIPMENT OF SMALL PACKAGES, THE AIR BILL SHOULD BE MARKED:

NOTIFY: UNIVERSAL TRANSCONTINENTAL CORP. UPON
ARRIVAL. TEL. NO. 212-995-7250

5. THE DESCRIPTIVE INFORMATION CONTAINED ON THE LABEL ALONG WITH THE FLIGHT INFORMATION (AIRLINE, FLIGHT NUMBER, ARRIVAL TIME AT JFK AIRPORT, AIR BILL NUMBER AND METHOD OF SHIPMENT - BAGGAGE OR FREIGHT) SHOULD BE GIVEN TO THE FIELD ENGINEERING TECHNICAL SUPPORT CENTER (FTSC) TO PASS ON TO FIELD ENGINEERING FIELD SUPPORT (FEFS) VIA THE CALL MANAGEMENT FACILITY OF RETAIN/370.

NOTE: THE REQUESTED INFORMATION MUST BE SUPPLIED AS SOON AS POSSIBLE. ANY DELAY OR DEVIATION FROM THIS PROCEDURE WILL RESULT IN A DELAY OF THE APAR SHIPMENT.

*ONLY LETTER SIZE ENVELOPES (4 1/8 X 9 1/2) MAY BE MAILED *
*DIRECT TO MAIL ADDRESS E,F,G,H,S AND CB, VIA AIR MAIL, *
*USING THE FOLLOWING ADDRESS: *
* * *

*MAIL ADDRESS	POSTAL ADDRESS	*
* E	APAR PROCESSING	*
*	IBM UNITED KINGDOM LABORATORIES	*
*	PROGRAMMING CENTRE	*
*	HURSLEY PARK	*
*	WINCHESTER-S 021 2JN	*
*	HAMPSHIRE, ENGLAND	*
* F	APAR PROCESSING D/293	*
*	COMPANIE IBM FRANCE	*
*	F-06610	*
*	LA GAUDE, FRANCE	*
* G	APAR PROCESSING	*
*	IBM PROGRAMMING SYSTEM DEPT. 7921	*
*	P. O. BOX 210	*
*	D-7030 BOEBLINGEN, GERMANY	*
* H	APAR PROCESSING	*
*	IBM LABORATORY CP5G D/266	*
*	P. O. BOX 24	*
*	UITHOORN, NETHERLANDS	*
* S	APAR PROCESSING	*
*	IBM NORDISKA LABORATORIER	*
*	P. O. BOX 962	*
*	S-18109 LINDINGO 9, SWEDEN	*
* CB	APAR PROCESSING	*
*	IBM UNITED KINGDOM LABORATORIES	*
*	MAILPOINT 189	*
*	HURSLEY PARK, WINCHESTER	*
*	HANTS, ENGLAND	*

INDICATE THE COMPONENT ID NUMBER AS WELL AS THE PRO-
GRAMMING SYSTEM ON THE DETACHABLE PORTION OF THE
LABEL. IF YOU DO NOT USE A PREPAID MAILING LABEL,
MARK THIS INFORMATION ON THE OUTSIDE OF THE PACKAGE.
FAILURE TO PROVIDE THIS INFORMATION WILL RESULT IN
UNNECESSARY DELAY IN THE DELIVERY OF YOUR APAR.

WORLD TRADE LOCATIONS SHOULD NOT USE THE UNIVERSAL TRANS-
CONTINENTAL CORPORATION OR THE PREPAID MAILER ADDRESS
WHEN MAILING APARS TO EUROPEAN SDD LOCATIONS.

PAGE OF : G229-2228-20
 REVISED : OCTOBER 1977
 BY TNL : GN25-0005-3

PGM NO.	SVC CLS	FESN BASE	COMP	MAIL ADDR.	PROGRAM TITLE	SUPP CODE	FTSC GROUP
1130							
-ALL-	C	099	0038		-ALL 1130 PROGRAMS-		
1401,1440,1450,1460,1500,1620							
-ALL-	C	099	0039		-ALL 1401,1440,1450,1460,1500 AND 1620 PROGRAMS-		
1800							
-ALL-	C	099	0039		-ALL 1800 PROGRAMS-		

360A							

CN-08X	C	099	0038		NUM CTL AUTOSPOT DOS		
CN-09X	C	099	0038		NUM CTL APT AUTO DOS		
CN-10X	C	099	0038		NUM CTL PROC APT OS		
CN-12X	C	099	0038		NUM CTL APT AUTO OS		
CO-18X	C	099	0038		LINEAR PGM SYS DOS		
CP-06X	C	099	0038		PROJ CNTL SYS DOS		
CX-12X	C	099	0038		DOC PROC SYS OS		
CX-15X	A	030	1509	AK	ASP SYS OS VERSION 2	13	ASP
	A	030	1519	AK	ASP SYS OS VERSION 3	13	ASP
CX-16X	C	099	0038		CGMT SYS MODEL OS		
CX-17X	C	099	0038		RMT ACCESS COM BPS		
CX-18X	C	099	0038		ADMIN TERM SYS BOS		
CX-19X	C	099	0038		ADMIN TERM SYS OS		
CX-26X	C	099	0038		PROB LANG ANAL DOS		
CX-27X	C	099	0038		PROB LANG ANAL OS		
CX-32X	C	099	0038		DECIS LOG TRANS DOS		
CX-34X	C	099	0038		PLAN GRAPH SUP 2250		
CX-42X	C	099	0038		CALL/360 OS		
CX-44X	C	099	0038		CALL/360 BASIC OS		
CX-45X	C	099	0038		CALL/360 PL/1 OS		
CX-46X	C	099	0038		CALL/360 FORTRAN OS		
DP-07X	C	099	0038		TXT PROC HYPEN/360		
DP-08X	C	099	0038		TXT PROC COMP/360		
DR-04X	C	099	0038		RET IMPACT SYS FASH		
DR-05X	C	099	0038		RET IMPACT SYS STPL		
DR-07X	C	099	0038		1287 INPUT CONV DOS		
DR-08X	C	099	0038		RET IMPACT SYS FASH		
DR-09X	C	099	0038		RET IMPACT SYS STPL		
DW-05X	C	099	0038		WHLSALE IMPACT D/B		
EM-04X	C	099	0038		MECH DGN SYS KINEMAT		
EO-15X	C	099	0038		PGM DPT SYS DGN OS		
FB-15X	C	099	0038		DEMAND DEP ACCT BOS		
FB-16X	C	099	0038		ONLINE TELLER BOS		
FI-06X	C	099	0038		OPT BOND BID BOS		
IF-10X	C	099	0038		PROP-LIAB INFO BASIC		
IF-11X	C	099	0038		PROP-LIAB INFO AUTO		
IF-13X	C	099	0038		PROP-LIAB INFO OTHR		
ME-07X	C	099	0038		PROD STRUC RETR		
MF-04X	C	099	0038		INVEN CTRL DOS		
MF-05X	C	099	0038		REQ PLANNING DOS		
SC-01X	C	099	0038		COMM CNTL APPL PGM		
SE-15X	C	099	0038		DATA CONV PGM UTIL1		
SE-19X	C	099	0038		1400 AUTOCD COB CON		
SE-20X	C	099	0038		DATA CONV PGM UTIL2		
SE-22X	C	099	0038		FLOW CHART DOS		
SE-23X	C	099	0038		DATA CONV-LBL T/DOS		
SE-26X	C	099	0038		DATA CONV PGM UTIL3		
SE-32X	C	099	0038		SYN TR/REC ACC METH		
SE-33X	C	099	0038		SYN TR/REC ACC METH		
ST-06X	C	099	0038		VEHICLE SCHED DOS		
SV-001	C	099	0038		S/360 RTM		

PGM NO.	SVC CLS	FESN BASE	COMP	MAIL ADDR.	PROGRAM TITLE	SUPP CODE	FTSC GROUP
TX-011	C	099	0038		DOS ASM/7		
TX-012	C	099	0039		DOS PREP/7		
TX-013	C	099	0039		DOS FORMAT/7		
TX-014	C	099	0039		DOS MACLIB/BASIC		
TX-015	C	099	0039		DOS LINK/7		
TX-016	A	030	0169	AF	DOS MACLIB/RELOCATE	27	
TX-021	C	099	0039		OS ASM/7		
TX-022	C	099	0039		OS PREP/7		
TX-023	C	099	0039		OS FORMAT/7		
TX-024	C	099	0039		OS MACLIB/BASIC		
TX-025	C	099	0039		OS LINK/7		
TX-026	A	030	0269	AF	OS MACLIB/RELOCATE	27	
TX-032	C	099	0038		S/370/DSP/DS		
UH-08L	C	099	0038		MISP		
UH-11X	C	099	0038		SHRD HOSP ACCT SHAS		
US-06X	C	099	0038		STUD SCHED T-C MAT		
US-07X	C	099	0038		STUD SCHED SCHED		
UX-01X	C	099	0038		COURSEWRITER III		
360B							
-ALL-	C	099	0039		-ALL 360B PROGRAMS-		
					-BASIC OPER SYS-		
360C							
-ALL-	C	099	0039		-ALL 360C PROGRAMS-		

360D							

051014	A	009	0149	AK	HASP		13 HASP
-REST-	C	099	0038		-ALL OTHER 360D PROGRAMS-		
NOTE - FOR RETAIN RETRIEVAL, OMIT THE FIRST CHARACTER TO THE RIGHT OF 360D. FOR EXAMPLE, RETAIN LABEL FOR 360D-05.1.014 IS 360D-51014.							
360F							
-ALL-	C	099	0039		-ALL 360F PROGRAMS-		
					-MOD 44 PS-		
360G							
CL-627	C	099	0038		360/67 TSS		

360H							

TX-033	A	029	0339	BG	3705 EP SUPPORT	23	3705 PROG
TX-034	A	029	0349	AL	3705 NCP1 FOR OS	23	3705 PROG
TX-035	A	029	0359	AL	3705 SSP FOR OS	23	3705 PROG
TX-036	C	099	0039		3705 SSP FOR DOS/360		
360M							
-ALL-	C	099	0039		-ALL 360M PROGRAMS-		
					-TAPE OPERATING SYS-		

360N-DOS							

AS-465	C	099	0032		DOS/360 ASM BASIC		
AS-466	C	099	0032		DOS/360 ASM F		
CB-452	C	099	0032		DOS/360 COBOL		
CB-468	C	099	0032		DOS/360 CBL DASD MAC		
CB-482	C	099	0032		DOS/360 ANS COBOL		
CL-453	C	099	0032		DOS/360 SYS CTL BA		
CQ-469	C	099	0032		DOS/360 BTAM		
CQ-470	C	099	0032		DOS/360 QTAM		
CQ-493	C	099	0032		3735 MACROS/UTIL.		
CV-489	C	099	0039		COBOL LCP		
DN-481	C	099	0032		DOS/360 DLTEP		
EU-484	C	099	0032		DOS/360 14XX EM CMP		
EU-485	C	099	0032		DOS/360 14XX EM CMP		

PAGE OF : G229-2228-20
 REVISED : OCTOBER 1977
 BY TNL : GN25-0005-3

PGM NO.	SVC CLS	FESN BASE	COMP	MAIL ADDR.	PROGRAM TITLE	SUPP CODE	FTSC GROUP
EU-490	C	099	0032		14XX EMUL S/370		
FO-451	C	099	0032		DOS/360 FORTRAN IV		
FO-479	A	002	4799	AK	DOS/360 FORTRAN IV	13	FORTRAN
		042	4799	AK	RELEASE 27 AND ABOVE	13	FORTRAN
IC-001	C	099	0032		DOS/360 2596		
IC-002	C	099	0032		DOS/BTAM 3270/3735		
IC-003	C	099	0039		MACROS AND UTIL SUPP		
		C	099	0039	RELEASE 27 AND ABOVE		
IO-454	C	099	0032		DOS/360 DA METHOD		
IO-455	C	099	0032		DOS/360 CONS DISK		
IO-456	C	099	0032		DOS/360 CONS TAPE		
IO-457	C	099	0032		DOS/360 ISFMS		
IO-458	C	099	0032		DOS/360 CONS PT		
IO-476	C	099	0032		DOS/360 CMPL IO MOD		
IO-477	C	099	0032		DOS/360 1259/1412/19		
IO-478	C	099	0032		DOS/360 OCR		
LM-480	A	002	4809	AK	DOS/360 FORT4 LIB	13	FORTRAN
		042	4809	AK	RELEASE 27 AND ABOVE	13	FORTRAN
PL-464	C	099	0032		DOS/360 PL/1		
PT-459	C	099	0032		AUTOTEST		
RG-460	C	099	0032		DOS/360 RPG		
SM-400	C	099	0032		DOS/360 SRT/MRGE TP		
SM-450	C	099	0032		DOS/360 S/MRG DK/TP		
SM-483	C	099	0032		DOS/360 S/MRG 2314		
SV-474	C	099	0032		DOS/360 SPR 6K 2311		
SV-486	C	099	0032		DOS/360 SPR 8K 2311		
UT-461	C	099	0032		DOS/360 GP1 UTIL		
UT-462	C	099	0032		DOS/360 GP2 UTIL		
UT-463	C	099	0032		DOS/360 GP3 UTIL		
UT-471	C	099	0032		DOS/360 MPS UTIL MAC		
UT-472	C	099	0032		DOS/360 VOC FILE UT		

360P

UT-213	A	004	2139	AK	OS/360 DASDI	13	UTILITY
UT-214	A	004	2149	AK	OS/360 DUMP RESTR.	13	UTILITY
UT-215	A	004	2159	AK	OS/360 RECOVERY	13	UTILITY
-REST-	C	099	0033		-ALL OTHER 360P PROGRAMS		
					-BASIC PROG SYS-		

360S-OS-RELEASE 210, 216, 217, 218

AL-531	C	099	0039		ALGOL F		
AS-036	C	099	0031		ASSEMBLER E 18K		
AS-037	C	099	0039		ASSEMBLER F		
CA-505	A	001	5051	AK	MFT DISK ERP	13	ERP
CA-535	A	001	5351	AK	MVT DISK ERP	13	ERP
CA-555	A	001	5551	AK	TSO DISK ERP	13	TSO
CA-566	C	099	0031		PCP DISK ERP		
CB-505	A	001	5051	AK	MFT UNIT REC ERP	13	ERP
CB-535	A	001	5351	AK	MVT UNIT REC ERP	13	ERP
CB-545	C	099	0031		ANS COBOL VER I		
CB-555	A	001	5551	AK	TSO UNIT REC ERP	13	TSO
CB-566	C	099	0031		PCP UNIT REC ERP		
CC-505	A	001	5051	AK	MFT TP ERP	13	ERP
CC-535	A	001	5351	AK	MVT TP ERP	13	ERP
CC-555	A	001	5551	AK	TSO TP ERP	13	TSO
CC-566	C	099	0031		PCP TP ERP		
CD-505	A	001	5051	AK	MFT 1419-1275 ERP	13	ERP
CD-535	A	001	5351	AK	MVT 1419-1275 ERP	13	ERP
CD-555	A	001	5551	AK	TSO 1419-1275 ERP	13	TSO
CD-566	C	099	0031		PCP 1419-1275 ERP		
CE-505	A	001	5051	AN	MFT 12XX ERP	02	ERP
CE-535	A	001	5351	AN	MVT 12XX ERP	02	ERP
CE-555	A	001	5551	AN	TSO 12XX ERP	02	TSO

PGM NO.	SVC CLS	FESN BASE	COMP	MAIL ADDR.	PROGRAM TITLE	SUPP CODE	FTSC GROUP
CE-566	C	099	0031		PCP 12xx ERP		
CF-505	A	001	5051	AN	MFT 2495 ERP	02	ERP
CF-535	A	001	5351	AN	MVT 2495 ERP	02	ERP
CF-555	A	001	5551	AN	TSO 2495 ERP	02	TSO
CF-566	C	099	0031		PCP 2495 ERP		
CG-505	A	001	5058	AK	MFT CHKPOINT RESTART	13	SUPERVISOR
CG-535	A	001	5358	AK	MVT CHKPOINT RESTART	13	SUPERVISOR
CG-555	A	001	5558	AK	TSO CHKPOINT RESTART	13	TSO
CG-566	C	099	0031		PCP CHKPOINT RESTART		
CI-514	A	001	5149	AK	STARTER SYSTEM	13	SUPERVISOR
CI-534	A	001	5349	AK	STARTER SYS/2314	13	SUPERVISOR
CI-555	A	001	5556	*	OS/360 UTILITIES		TSO
* USE THE FOLLOWING APAR MAILING ADDRESSED FOR							
PROGRAM ID CI-555 MODULES:							
AK- IKJLKL01, IKJLKL02, IKJLKM5G							
AX- ALL OTHER MODULES							
CK-555	A	001	5553	AX	TSO TIOC	23	TSO
CL-555	A	001	5552	AK	LINK LOADGO PROMPTER	13	TSO
CN-505	A	001	5056	AX	SMF SAMPLIB PARMLIB	02	JOB MGMT
CN-535	A	001	5356	AX	SMF SAMPLIB PARMLIB	02	JOB MGMT
CO-503	C	099	0031		COBOL E		
CP-505	A	001	5051	BG	MFT GTF	02	SERVICE AID
CP-535	A	001	5351	BG	MVT GTF	02	SERVICE AID
CP-555	A	001	5551	BG	TSO GTF	02	TSO
CQ-513	A	001	5139	CE	BTAM-2740 MCS	02	BTAM
CQ-519	C	099	0031		QTAM		
CQ-563	C	099	0031		3735 MACROS AND UTIL		
C1-548	A	001	5481	AL	TCAM	23	TCAM
C2-505	A	001	5052	BG	SUPERVISOR MFT	02	SUPERVISOR
C2-535	A	001	5352	BG	SUPERVISOR MVT	02	SUPERVISOR
C2-548	A	001	5482	AL	TSO TCAM	23	TSO TCAM
C2-555	A	001	5552	BG	SUPERVISOR TSO	02	TSO
C2-566	C	099	0031		SUPERVISOR PCP		
C3-505	A	001	5053	AK	IOS MFT	13	IOS
C3-535	A	001	5353	AK	IOS MVT	13	IOS
C3-548	A	001	5483	AL	TOTE	23	IOS
C3-555	A	001	5553	AK	IOS TSO	13	IOS
C3-566	C	099	0031		IOS PCP		
C4-505	A	001	5054	BG	MFT GRAPH OPR SUPP	02	SUPERVISOR
C4-535	A	001	5354	BG	MVT GRAPH OPR SUPP	02	SUPERVISOR
C4-548	A	001	5484	AX	TSO TCAM SUBROUTINES	23	TSO TCAM
C4-555	A	001	5554	BG	TSO GRAPH OPR SUPP	02	TSO
C4-566	C	099	0031		PCP GRAPH OPR SUPP		
C5-505	A	001	5055	AX	MFT SCHED	02	JOB MGMT
C5-535	A	001	5355	AX	MVT SCHED	02	JOB MGMT
C5-555	A	001	5555	AX	TSO SCHED	02	TSO
C5-566	C	099	0031		PCP SCHED		
C6-505	A	001	5052	AK	MFT LKED OVLY SUPVR	13	SUPERVISOR
C6-535	A	001	5352	AK	MVT LKED OVLY SUPVR	13	SUPERVISOR
C6-555	A	001	5552	AK	TSO LKED OVLY SUPVR	13	TSO
C6-566	C	099	0031		PCP LKED OVLY SUPVR		
C7-505	A	001	5057	AK	MFT SYSOUT WRITER	13	JOB MGMT
C7-535	A	001	5357	AK	MVT SYSOUT WRITER	13	JOB MGMT
C7-555	A	001	5557	AK	TSO SYSOUT WRITER	13	TSO
C7-566	C	099	0031		PCP SYSOUT WRITER		
C9-505	A	001	5059	AK	MFT SYSGEN MACROS	13	SYSGEN
C9-535	A	001	5359	AK	MVT SYSGEN MACROS	13	SYSGEN
C9-555	A	001	5559	AK	TSO SYSGEN MACROS	13	TSO
C9-566	C	099	0039		PCP SYSGEN MACROS		
DM-509	C	099	0039		BDAM		
DN-527	A	001	5272	BG	SERO/1/OBR/EREPO	02	SUPERVISOR
DN-533	A	001	5339	BG	OLTEP	02	OLTEP

PAGE OF : G229-2228-20
 REVISED : OCTOBER 1977
 BY TNL : GN25-0005-3

PGM NO.	SVC CLS	FESN BASE	MAIL COMP	PROGRAM ADDR.	TITLE	SUPP CODE	FTSC GROUP
DN-539	A	001	5399	BG	RECOVERY MGMT M65	02	SUPERVISOR
DN-611	A	001	6111	CF	HMASMP	02	SMP
DN-614	A	001	6141	CF	POWER WARNING FEAT	02	SUPERVISOR
D1-508	A	001	5081	AK	OPEN/CLOSE/EOV	13	DATA MGMT
D1-527	A	001	5271	BG	155 ERROR RECOVERY	02	SUPERVISOR
D1-554	A	001	5544	BG	IMDSADMP	02	SERVICE AID
D2-508	A	001	5082	AK	ACCESS METHODS	13	DATA MGMT
D2-554	A	001	5544	BG	IMDPRDMP	02	SERVICE AID
D3-508	A	001	5083	AK	CATALOG	13	DATA MGMT
D3-554	A	001	5541	BG	IMASPZAP	02	SERVICE AID
D4-508	A	001	5084	AK	DADSM	13	DATA MGMT
D4-554	C	099	0039		IMAPTFILE		
D5-508	A	001	5085	AN	OPT/RDR 12XX	02	DATA MGMT
D5-554	A	001	5543	BG	IMCJODMP	02	SERVICE AID
D6-508	A	001	5086	AK	RDR 1419/1275	13	DATA MGMT
D6-554	C	099	0039		IMAPTFLS		
D7-508	A	001	5087	AK	DM CHKPT RESTART	13	DATA MGMT
D7-554	A	001	5542	BG	IMBMDMAP	02	SERVICE AID
D8-508	A	001	5088	AK	2245-3211 SUPPORT	13	DATA MGMT
D8-554	A	001	5545	AK	IMBLIST	13	SERVICE AID
D9-508	A	001	5089	BN	3505-3523 SUPPORT	02	DATA MGMT
ED-510	C	099	0039		LKED E 15K,18K		
ED-521	C	099	0039		LKED F		
FO-092	C	099	0039		FORTTRAN E 15K		
FO-500	C	099	0039		FORTTRAN 4 H		
FO-520	C	099	0039		FORTTRAN 4 G		
FO-550	C	099	0039		FORTTRAN SYNTAX CHK		
IO-523	C	099	0039		GRAPH PGM SVCS		
IO-526	C	099	0039		ISAM		
LD-547	C	099	0039		LOADER		
LM-501	C	099	0039		FORTTRAN LIBRARY		
LM-504	C	099	0039		COBOL E LIBRARY		
LM-512	C	099	0039		PL/I SUB LIBRARY		
LM-532	C	099	0039		ALGOL F LIBRARY		
LM-537	C	099	0039		GRAPH SUB PGM		
LM-542	C	099	0039		1130/360 DATA TRANS		
LM-546	C	099	0039		USA STAND COBOL LIB		
NL-511	C	099	0039		PL/I F		
PL-552	C	099	0039		PL/I SYNTAX CHK		
PT-516	C	099	0039		TESTRAN		
RC-536	C	099	0039		RJE		
RC-541	C	099	0039		GRAPH JOB PROC		
RC-543	C	099	0039		SATE GRAPH JOB		
RC-551	C	099	0039		CRJE		
RG-038	C	099	0039		RPG		
SM-023	C	099	0039		SORT/MERGE		
UA-506	C	099	0039		IEBEDIT		
UB-506	C	099	0039		IEBUPDAT		
UC-506	C	099	0039		IEBCOMPR		
UD-506	C	099	0039		IEHIOSUP		
UE-506	C	099	0039		IHGUAU		
UF-506	C	099	0039		IEHUCSLD		
UG-506	C	099	0039		IEBTGRIN		
UH-506	C	099	0039		IEHATLAS		
UJ-506	C	099	0039		IFHSTATR		
UK-506	C	099	0039		IEHDASDR		
UL-506	C	099	0039		TSD EDIT		
UM-506	C	099	0039		TSD UTILITIES		
UN-506	C	099	0039		TSD UTIL COMMANDS		
UP-506	C	099	0039		TSD UTIL OUTPUT		
UT-506	C	099	0039		OS/360 UTILITIES		

PGM NO.	SVC CLS	FESN BASE	COMP	MAIL ADDR.	PROGRAM TITLE	SUPP CODE	FTSC GROUP
UT-507	C	099	0039		INDEPENDENT UTIL		
UT-558	A	001	5582	BN	IEHMAN		02 UTILITY
U1-506	C	099	0039		IEHMOVE		
U2-506	C	099	0039		IEBUPDTE		
U2-507	C	099	0039		IBCOMPRS		
U3-506	C	099	0039		IEBCOPY		
U3-507	C	099	0039		IBCDASDI		
U4-506	C	099	0039		IEBGENR		
U4-507	C	099	0039		IBRCVVRP		
U5-506	C	099	0039		IEHLIST		
U5-507	C	099	0039		ICAPRTBL		
U6-506	C	099	0039		IEBISAM		
U7-506	C	099	0039		IEHPRDGM		
U8-506	C	099	0039		IEBPTPCH		
U9-506	C	099	0039		IEHINITT		
U0-506	C	099	0039		IEBDG		

360T, 360U, 360V, 360W							

-ALL-	C	099	0038		-ALL 360T PROGRAMS-		
-ALL-	C	099	0038		-ALL 360U PROGRAMS-		
-ALL-	C	099	0038		-ALL 360V PROGRAMS-		
-ALL-	C	099	0038		-ALL 360W PROGRAMS-		

370H							

TX-001	A	028	0019	AK	HASP II VERSION 4		13 HASP

370N-DDS							

AS-465	C	099	0039		DOS/370 ASSEMBLER		
CL-453	C	099	0039		DOS/370 SYS CTL BA		
CQ-469	C	099	0039		DOS/370 BTAM		
CQ-470	C	099	0039		DOS/370 QTAM		
CQ-493	C	099	0039		DOS/370 3735 TRM SUP		
DN-481	C	099	0039		DOS/370 OLTEP		
EU-490	C	099	0039		DOS/370 14XX EMUL		
IC-001	C	099	0039		3275 SWITCHED SUPPT		
IC-002	C	099	0039		DOS/370 MOD 20 EM		
IC-003	C	099	0039		3735 TERMINAL SUPT		
IC-004	C	099	0039		MODEL 125 SUPT		
IO-454	C	099	0039		DOS/370 DA METHOD		
IO-455	C	099	0039		DOS/370 CONS DISK		
IO-456	C	099	0039		DOS/370 CONS TAPE		
IO-457	C	099	0039		DOS/370 ISFMS		
IO-458	C	099	0039		DOS/370 CONS PT IOCS		
IO-476	C	099	0039		DOS/370 Cmpl IO MOD		
IO-477	C	099	0039		DOS/370 1259/1412/19		
IO-478	C	099	0039		DOS/370 OCR		
SV-495	C	099	0039		DOS/370 2311/14/3330		
UT-491	C	099	0039		DOS/370 SYS UTIL PRG		
UT-492	C	099	0039		DOS/370 EREP		

370S							

DL-002		310	0029	AH	DATA LINK SOFTWARE		

PAGE OF : 6229-2228-20
 REVISED : OCTOBER 1977
 BY TNL : GN25-0005-3

PGM NO.	SVC	FESN	MAIL	PROGRAM TITLE	SUPP	FTSC
NO.	CLS	BASE	COMP	ADDR.	CODE	GROUP

5701-SYS/3-MOD 10 (CARD SYSTEM)						

D11	C	099	0038	S/3 UNIT INV TECH		
D12	C	099	0038	APPAREL BUS CTRL		
D51	C	099	0038	S/3 OPT BLNDG		
G21	C	099	0038	S/3 LAW ENFORCE SYS		
G22	C	099	0038	S/3 APPROP ACTG SYS		
G23	C	099	0038	S/3 CITA PROC SYS		
G24	C	099	0038	S/3 UTIL BILL SYS		
M41	C	099	0038	S/3 ORDER PT TECH		
M42	C	099	0038	S/3 CARD BILL MATL		
N21	C	099	0038	S/3 P&L AGENCY SYS		
RG1	C	099	0038	S/3 CARD RPG II		
SC1	SCP	161	0009	AP S/3 CARD SYSTEM	10	
SM1	C	099	0038	S/3 TAPE SORT		
UT1	C	099	0039	S/3 CARD SYS UTIL		

5702-SYS/3 MOD 10 (DISK SYSTEM)						

AS1	A	262	0369	AP S/3 BASIC ASSM	10	
CB1	A	262	2559	AP S/3 ANS COBOL	10	
FD1	A	262	2569	AP S/3 FORTRAN IV	10	
K11	B	099	0028	AB S/3 FOR TV AND RADIO	CH	
M41	B	099	0028	AB S/3 BM PROC	CH	
M52	B	099	0028	AB S/3 INV RQMNTS PLNG	CH	
P21	C	099	0038	PROCUP MODEL 10		
RG1	A	262	0379	AP S/3 DISK RPG II	10	
SC1	SCP	162	0019	AP S/3 DISK SYSTEM	10	
		162	1039	AP S/3 C.C.P. FEATURE	10	
		162	1059	AP S/3 M.R.J.E. FEATURE	10	
SM1	A	262	0389	AP S/3 DISK SORT	10	
SM2	C	099	0038	S/3 TAPE SORT		
UT1	A	262	0399	AP S/3 CARD UTIL	10	
UT2	A	262	1669	AP S/3 1255 UTIL	10	
XN1	C	099	0038	APT-BC		
XP1	B	099	0028	N JAS/3	WP	
XX1	B	099	0028	DATA/3 LOGIC		

5703-SYS/3-MOD 4 & 6						

FD1	A	263	3479	AP S/3 FORTRAN IV	10	
N11	B	099	0028	HEALTH,WELF,PENS FND	WP	
P21	C	099	0038	PROCUP MODEL 6		
IL-09X	C	099	0038	ADV LIFE INFO S/DOS		
ME-06X	C	099	0038	BM PROC B/DOS		
RG1	A	263	1729	AP S/3 DISK RPG II	10	
SC1	SCP	163	0039	AP S/3 DISK SYSTEM	10	
		163	1069	AP S/3 M.R.J.E. FEATURE	10	
		163	1089	AP S/3 CCP FEATURE	10	
SM1	A	263	1739	AP S/3 DISK SORT	10	
SM2	A	263	1759	AP S/3 CCP/DISK SORT	10	
UT1	A	263	1749	AP S/3 CONV UTIL	10	
UT2	C	099	0039	S/3 1255 UTIL		
XA1	C	099	0038	STAT/BASIC		
XM1	C	099	0038	S/3 BASIC		
XM2	B	099	0028	BL S/3 MOD 6 MATH/BASIC	13	
XM3	C	099	0038	S/3 M6 BUS ANL/BASIC		

PGM NO.	SVC CLS	FESN BASE	COMP	MAIL ADDR.	PROGRAM TITLE	SUPP CODE	FTSC GROUP

5704-SYS/3-MOD 15 (A,B,C)							

AS1	A	264	3619	AP	BASIC ASSM		10
CB1	A	264	3599	AP	ANS COBOL		10
FO1	A	264	3609	AP	FORTRAN IV		10
RG1	A	264	3589	AP	RPG II		10
SC-1	SCP	164	0879	AP	DISK SCP		10
		164	1019	AP	CCP FEATURE		10
		164	1079	AP	M.R.J.E. FEATURE		10
SM1	A	264	3629	AP	DISK SORT		10
SM2	A	264	3639	AP	TAPE SORT		10
UT1	A	264	3649	AP	UTILITIES		10
XX1	B	099	0028		DATA/3 LOGIC		

5704-SYS/3-MOD 15D							

AS2	A	264	3659	AP	BASIC ASSEM		10
CB2	A	264	3669	AP	ANS COBOL		10
FO2	A	264	3679	AP	FORTRAN IV		10
RG2	A	264	3689	AP	RPG II		10
SC2	S	164	1089	AP	DISK SCP		10
		164	1099	AP	CCP FEATURE		10
		164	1109	AP	M.R.J.E. FEATURE		10
SM7	A	264	3709	AP	CCP/DISK SORT		10
SM8	A	264	3719	AP	TAPE SORT		10
SM9	A	264	3699	AP	DISK SORT		10
UT3	A	264	3729	AP	UTILITIES		10

5705-SYS/3-MGD 12							

AS1	A	265	0059	AP	BASIC ASSM		10
CB1	A	265	0039	AP	COBOL		10
FO1	A	265	0049	AP	FORTRAN IV		10
RG1	A	265	0029	AP	RPGII		10
SC1	SCP	165	0019	AP	DISK SCP		10
		165	0029	AP	CCP FEATURE		10
		165	0039	AP	MRJE FEATURE		10
SM1	A	265	0069	AP	DISK SORT		10
SM2	A	265	0079	AP	TAPE SORT		10
UT1	A	265	0089	AP	UTILITIES		10
UT2	A	265	0099	AP	1255 UTILITIES		10

5707-SYS/7							

AA1	SCP	151	0900	AF	SYS/7 PPF		27
AB1	SCP	151	0919	AF	MSP/7 PROCLIB		27
AC1	SCP	151	0929	AF	MSP/7 SYSCODE		27
AD1	SCP	151	0939	AF	MSP/7 ASM/7		27
AE1	SCP	151	0949	AF	MSP/7 SLE		27
AF1	SCP	151	0959	AF	MSP/7 LINK/7		27
AG1	SCP	151	0969	AF	MSP/7 DSS/7 8-12K		27
FO1	A	251	3679	AF	MSP/7 FORT IV		27
F12	B	099	0028		GRAPHICS FEAT		
LM1	C	099	0038		APPL MODULE LIB/7		
M31	C	099	0038		MMS OS/VS		
M32	C	099	0038		MMS DGS/VS		
M33	B	099	0028	G	MMS OS/VS V 2		ST
M34	B	099	0028	G	MMS DOS/VS V 2		ST
RC1	C	099	0038		CCAP/7		
RC2	B	099	0028	V	CCAP/7 VER 2		WA
SC2	SCP	151	0449	AF	MSP/7 DSS/7		27

PAGE OF : G229-2228-20
 REVISED : OCTOBER 1977
 BY TNL : GN25-0005-3

PGM NO.	SVC	FESN	MAIL	PROGRAM TITLE	SUPP	FTSC
	CLS	BASE	COMP	ADDR.	CODE	GROUP
T12	B	099	0028	ACD-MONITOR	W	WP
U11	B	099	0028	ENERGY MGMT SYSTEM		
XC1	B	099	0028	APG/7		
XN3	C	099	0038	PCP/7 OS		
XN4	C	099	0038	PCP/7 DOS		
XN5	C	099	0038	PCP/7 PREP		
XR1	C	099	0038	TGS/7		

5711-1130

-ALL- C 099 0038 -ALL 1130 PROGRAMS-

5718-1800

H11	C	099	0038	1800 CLDAS		
H12	C	099	0038	1800 CLMS		
P81	C	099	0038	PROSPRO II		
RG1	C	099	0038	1800 RPG		
SC2	SCP	151	*	AF S/7 SCP		27

*USE THE FOLLOWING COMPONENT NUMBERS FOR

BASE NUMBER 151

0051 IPL/LOADER

0052 ASSEMBLER

0053 UTILITIES

0054 SUBROUTINES

0055 SAMPLE PROGRAM

XX1 C 099 0038 1800 CHROMA MON.

5719-SERIES/1

AS1	319	0010	AE	PROG PREP SUBSYSTEM		27
AS-1AB	319	0010	AE	APPLICATION BUILDER		27
AS-1IN	319	0010	AE	PROG PREP INSTALL		27
AS-1JS	319	0010	AE	JOB STREAM PROCESSOR		27
AS-1MA	319	0010	AE	MACRO ASSEMBLER		27
AS-1TE	319	0010	AE	TEXT EDITOR		27
FD1	319	3931	AE	FORT COMP & OBJ LIB		27
FD3	319	3933	AE	FORT REALTIME SUB LIB		27
LM1	319	3941	AE	MFSL		27
PC1	319	0011	AE	REALTIME PROG SYSTEM		27
PC-1CM	319	0011	AE	COMMUNICATIONS		27
PC-1DM	319	0011	AE	DATA MANAGEMENT		27
PC-1SG	319	0011	AE	SYSTEM GENERATION		27
PC-1SS	319	0011	AE	SUPERVISOR		27
PC-1UT	319	0011	AE	UTILITIES		27
PL1	319	3951	AE	PL/1 COMP & RES LIB		27
PL3	319	3953	AE	PL/1 TRANSIENT LIB		27
SC2 SCP	119	3911	AE	STANDALONE UTILITIES		27
U11	219	3911	BO	FC/PM1		27
U12	219	3912	BO	FC/PM2		27
	219	3913	BO	FC/PM3		27
	219	3914	BO	APPU		27

PGM NO.	SVC CLS	FESN BASE	MAIL COMP	ADDR.	PROGRAM TITLE	SUPP CODE	FTSC GROUP

5725-SYSTEM/32							

RG-1AR	.A	225	3709	CC	RPG II AUTO REPORT	10	
RG-1BS	A	225	3709	CC	RPG II BSC SUPPORT	10	
RG-1RG	A	225	3709	CC	RPG II COMPILER	10	
SC-1BA	SCP	125	1040	CC	\$BACK BACKUP LIB UTL	10	
SC-1BI	SCP	125	1040	CC	\$BICR INTRCHG UTL	10	
SC-1BS	SCP	125	1040	CC	BSC IOS	10	
SC-1BW	SCP	125	1070	CC	BWS/SNA/SDLC	10	
SC-1BU	SCP	125	1040	CC	\$BUILD ALT SECT ASSG	10	
SC-1CE	SCP	125	1040	CC	CE DIAG AIDS	10	
SC-1CN	SCP	125	1040	CC	CNFIGSCP SCP INSTALL	10	
SC-1CO	SCP	125	1040	CC	\$COPY DISK COPY UTL	10	
SC-1CS	SCP	125	1040	CC	CNTL STORE UCODE	10	
SC-1DE	SCP	125	1040	CC	\$DELETE FILE DELETE	10	
SC-1DM	SCP	125	1040	CC	DATA MANAGEMENT	10	
SC-1DU	SCP	125	1040	CC	\$DUPRD DISKETTE COPY	10	
SC-1HI	SCP	125	1040	CC	\$HIST HISTORY DISP	10	
SC-1IN	SCP	125	1040	CC	\$INIT DISKETTE INIT	10	
SC-1LA	SCP	125	1040	CC	\$LABEL VTGC DISPLAY	10	
SC-1LE	SCP	125	1040	CC	LINKAGE EDITOR	10	
SC-1LO	SCP	125	1040	CC	\$LOAD RELOAD LIB	10	
SC-1MA	SCP	125	1040	CC	\$MAINT LIB MAINT	10	
SC-1MG	SCP	125	1040	CC	\$MGBLD CREATE MSG	10	
SC-1MR	SCP	125	1050	CC	MRJE	10	
SC-1PA	SCP	125	1040	CC	\$PACK DISK REDRG	10	
SC-1RE	SCP	125	1040	CC	\$REBLD REBUILD DATA	10	
SC-1SE	SCP	125	1040	CC	\$SETCF SET UTL	10	
SC-1SH	SCP	125	1040	CC	SCHEDULER	10	
SC-1ST	SCP	125	1040	CC	\$STATS STATUS DISP	10	
SC-1US	SCP	125	1040	CC	\$USOD SYNTAX CHECK	10	
SC-1WP	SCP	125	1060	DA	WORD PROCESSING FEAT	10	
UT-1DS	A	225	3719	CC	DISK SORT	10	
UT-1DF	A	225	3729	CC	DATA FILE UTL	10	
UT-1SE	A	225	3739	CC	SOURCE ENTRY UTL	10	
XX-1WP	A	225	3759	DB	WORD PROCESSOR/32	10	

PAGE OF : G229-2228-20
 REVISED : OCTOBER 1977
 BY TNL : GN25-0005-3

PGM NO.	SVC	FESN	MAIL	PROGRAM TITLE	SUPP	FTSC
	CLS	BASE	COMP	ADDR.	CODE	GROUP

5734-OS/V5 PP						

AS-100	C	099	0039	ASSEMBLER H		
CB-101	C	099	0039	FULL ANS COBOL V3		
CB-202	A	2**	1449	AK OS FULL ANS COBOL V4	13	COBOL
CB4	B	099	0028	AK COBOL INTER DEBUG	WP	
CP-101	A	2**	1469	AK TSO COBOL PROMPTER	13	COBOL
CP-201	C	099	0039	TSO ASSEMBLER PROMPT		
CP-301	C	099	0038	TSO FORTRAN PROMPTER		
CP4	C	099	0038	ALGOL-F PROMPTER		
D32	C	099	0038	OS COGS ALLOCATION		
D33	C	099	0038	OS COGS FORECAST		
EE1	C	099	0038	ELEC CKT ANAL PGM II		
E12	C	099	0038	COURSE WRITER III V2		
E13	B	099	0028	V CRSWRTR III OS V3	WP	
FO-101	C	099	0039	CODE AND GO FORTRAN		
FO-201	A	2**	1509	AK FORTRAN IV G1 COMP	13	FORTRAN
FO-301	A	2**	1479	AK FORTRAN IV H EXT CMP	13	FORTRAN
FO-401	A	251	3009	AF OS FORT/7	27	FORTRAN
F05	B	099	0028	AK FORTRAN INTER DEBUG	WP	
F11	B	099	0028	N CHECK PROC CTRL SYS	WP	
F31	B	099	0028	AC TELECOMM CTL TCS	WP	
F32	B	099	0028	AC SEC ORDER MATCH	WP	
F34	B	099	0028	N REGISTERED REP SYS	WP	
F51	C	099	0038	BUDPLAN OS - WTC		
G21	C	099	0038	OS FASTER MT		
H11	B	099	0028	N ECG ANALYSIS/OS	WP	
LM-101	C	099	0039	FORTRAN IV LIB MOD 1		
LM-201	A	2**	1449	AK COBOL V4 LIB ONLY	13	COBOL
LM-301	A	2**	1489	AK FORTRAN IV LIB MOD 2	13	FORTRAN
LM-441	A	2**	1919	AK OS PL/1 RESIDENT LIB	13	PL1
LM-541	A	2**	1929	AK OS PL/1 TRANS LIB	13	PL1
M31	C	099	0038	OS/360 SHOP FL CTRL		
M41	B	099	0028	AB OS/360 CAPOSS	ST	
M51	C	099	0038	OS/360 REQUIRE PLAN		
M52	C	099	0038	OS/360 INVENTORY CTR		
M53	C	099	0038	OS CAP PLAN INFINITE		
M54	C	099	0038	OS CAP PLAN FINITE		
PL-141	A	2**	1949	AK OS PL/1 OPT COMP	13	PL1
PL-241	A	2**	1679	AK OS PL/1 CHECKOUT CMP	13	PL1
RC-102	C	099	0038	OS-ITF PL1		
RC-202	C	099	0038	TSO-ITF PL1		
RC-302	C	099	0038	OS-ITF BASIC		
RC-402	C	099	0038	TSO-ITF BASIC		
RC-500	A	2**	2389	E OS/VIDEO/370	62	VIDEO 370
SM-102	C	099	0039	OS SORT/MERGE 1		
UT-101	C	099	0039	TSO DATA UTILITIES		
UT2	C	099	0038	OS OS UTIL W/ASCII		
UT3	C	099	0038	OS BASIC UNIFORM RD		
XA2	C	099	0038	STAFOS		
XA3	B	099	0028	BL STAT/BASIC	13	
XC3	B	099	0028	BO	MP	
XC4	B	099	0028	OS/DMS-3270		
XMB	B	099	0028	BL BUS ANAL/BASIC ITF	13	
XMC	C	099	0038	MGRW		
XM1	B	099	0028	AK APL OS	13	
XM3	C	099	0038	PL/MATH		
XM4	B	099	0028	N MPX/GUB	WP	
XM5	C	099	0038	VEHICLE SCHED PROG		
XM-641	C	099	0039	APL OS		

** - RECORD THE OPERATING SYSTEM OF PROGRAM PRODUCT:
 DO NOT USE 042 FOR DOS REGARDLESS OF THE RELEASE LEVEL
 JS & OTHER - 01, OS/V51 - 52, SVS - 53, MVS - 55,
 VM/370 - 54, DOS - 02, DOS/V5 - 56

PGM NO.	SVC	FESN	MAIL	PROGRAM TITLE	SUPP CODE	FTSC GROUP
NO.	CLS	BASE	COMP	ADDR.		
XM8	B	099	0028	BL MATH/BASIC ITF		
XP3	C	099	0038	MINIPERT		
XP4	B	099	0028	N PROG MGMT SYS OS		WP
XR2	C	099	0038	DECTAT		
XR3	C	099	0038	STAIRS		
XS2	C	099	0038	GPSS V OS		
XS3	C	099	0038	DATA 360 OS		
XS7	C	099	0038	FAMS OS		
XS8	C	099	0038	DATA/360 OS		
XS9	C	099	0038	CSMP III		
XXB	C	099	0038	SIMPL/I - WTC		
XXC	B	099	0028	N ITS/OS		WP
XX-100	A	2**	0789	AK GIS/2.2		13 GIS
XX2	C	099	0038	S/360 GATD OS		
XX-634	A	2**	0999	AK IMS/360 V2 DATA BASE	13	IMS
				IMS/360 V2 DATA COMM	13	IMS
XX-635	A	2**	0999	AK IQF/IMS	13	IMS
XX-701	A	2**	3019	CB CICS/OS-STANDARD V2	13	CICS-OS
				8W FERS		03
XX8	C	099	0038	LEARN ATS-OS		
XX9	C	099	0038	IMS/BOMP BRIDGE		

5735						

ICV1	A	264	3579	G DOS/VS RP311 CONV		64
E91	C	099	0038	EPIC - SOCRATES 3881		
E92	C	099	0038	EPIC - FAST		
E93	C	099	0038	EPIC - BUDGET/FIN		
E94	C	099	0038	EPIC - STUDENT		
SC1	SCP	135	0329	BG EP SUPPORT VS	23	3705 PROG
SC2	SCP	135	0309	AL NCP2 SUPPORT VS	23	3705 PROG
SC3	SCP	135	0709	AL NCP3 SUPT DOS/OS/VS	23	3705 PROG

5736-DOS DOS/VS PP						

CB-102	C	099	0038	DOS ANS SUBSET COBL		
CB-201	A	202	2049	G DOS/FULL ANS COBL V3	64	COBOL
CX1	C	099	0038	GIS OS		
CX3	C	099	0038	IMS OS VI		
D11	C	099	0038	FASHION REPORT SYS		
D31	C	099	0038	COGS ALLOCATION DOS		
D32	C	099	0038	COGS FORECAST DOS		
D41	C	099	0038	OAS DUS		
D51	B	099	0028	AB AGRI BUS MANG INFO		CH
E11	B	099	0028	V CRSWRTR III DOS		
FC1	A	251	2999	AF DOS FORT/7		27
F12	C	099	0038	FIN TERM SYS		
F31	C	099	0038	BASE VER 2		
F32	C	099	0038	ACTIVE CIR INFO ACIP		
G21	C	099	0038	S/360 LEMRAS DOS		
G22	B	099	0028	V FASTER LC		WA
G24	C	099	0038	DOS FASTER MT		
G25	C	099	0038	BUDGET ACCT INFO SYS		
G26	C	099	0038	BASIC COURTS SYS		
H12	C	099	0038	SHARED LIB INFO SYS		
H15	B	099	0028	N ECG ANALYSIS/DOS/VS		WP
K12	C	099	0038	PAGINATION DOS		
LM-201	A	2**	2109	G DOS F/ANS COBL LIB 3	02	COBOL
LM-461	A	2**	2119	AK DOS PL/1 RES LIB	13	PL1
LM-561	A	2**	2129	AK DOS PL/1 TRANS LIB	13	PL1
M11	C	099	0038	S/360 CAP PLN INF LD		

** - RECORD THE OPERATING SYSTEM OF PROGRAM PRODUCT:
 QQ NDI USE 042 FOR DOS REGARDLESS OF THE RELEASE LEVEL
 OS & OTHER - 01, OS/VS1 - 52, SVS - 53, MVS - 55,
 VM/370 - 54, DOS - 02, DOS/VS - 56

PAGE OF : G229-2228-20
 REVISED : OCTOBER 1977
 BY TNL : GN25-0005-3

PGM NO.	SVC CLS	FESN BASE	MAIL COMP	MAIL ADDR.	PROGRAM TITLE	SUPP CODE	FTSC GROUP
M12	C	099	0038		S/360 CAP PLN FIN LD		
M13	C	099	0038		S/360 REQ PLN INTRFC		
M31	C	099	0038		DOS/360 SHOP FL CNTR		
M41	B	099	0028	G	DOS/360 CAPOSS	ST	
M61	C	099	0038		PACIFIC-ESTIMATING		
M62	C	099	0038		PACIFIC-COST CONTROL		
M63	C	099	0038		PACIFIC-WORK MEASURE		
N11	C	099	0038		ALIS VER II DOS		
N13	B	099	0028	AB	CFD 11		CH
N14	B	099	0028	AB	ALPHA SEARCH		CH
N21	C	099	0038		PLIS DOS		
N22	C	099	0038		PALIS ADD FILE M1		
N24	C	099	0038		PALIS		
PL-161	A	2**	2169	AK	DOS PL/1 OPT COMP	13	PL1
P71	C	099	0038		ARRAY PROC SUBR M44		
P72	C	099	0038		ARRAY PROC SUBR OS		
RC-101	C	099	0039		DOS-ITF PL1		
RC-201	C	099	0039		DOS-ITF BASIC		
RC-300	A	2**	2399	E	DOS/VIDEO/370	62	VIDEO 370 DOS
RG-101	A	2**	1279	G	DOS RPG II	64	RPG
RG-1AR	A	2**	1279	G	AUTO REPORT	64	RPG
SM-101	C	099	0038		DOS TAPE/DISK S/M		
T11	B	099	0028	N	FARE QUOTE/TICKETING	MP	
T21	C	099	0038		TARIFF PUBLISH SYS		
T22	C	099	0038		TRAFFIC PROFILE ANAL		
UT1	C	099	0038		DOS BASIC UNFORM RD		
UT2	C	099	0038		ASCII II UTIL MAG TP		
UT4	B	099	0028	G	DOS/360 UDB	ST	-WT ONLY-
U12	C	099	0038		POWER SYS PLNG OS		
XC3	B	099	0028	BD	DOS S/7 APG	MP	
XC4	B	099	0028		DMS II DOS/V5		
XM3	C	099	0038		VEHICLE SCHED PROG		
XM-641	C	099	0039		APL DOS		
XM7	C	099	0038		S/360-S/370 SL MATH		
XP2	C	099	0038		REAL/360		
XS2	C	099	0038		DATA 360		
XS3	C	099	0038		GPSS V DOS		
XS4	C	099	0038		FAMS DOS		
XT2	B	099	0028		SPF/TSD		
XX2	C	099	0038		CATALIST		
XX3	C	099	0038		LEARN ATS-DOS		
XX4	C	099	0038		DATA BASE DRG & MAIN		
XX-600	A	2**	1629	CB	CICS/DOS-ENTRY	13	CICS-DOS
XX-700	A	2**	1639	CB	CICS/DOS-STANDARD	13	CICS-DOS
				BW	FERS	03	

 5740-OS/V5 PP

CB-103	A	2**	3779	AK	OS/V5 COB COMPILER	13	COBOL
LM-103	A	2**	3779	AK	OS/V5 COBOL LIB	13	COBOL
I1-214	A	2**	3841	AK	IMVS/V5 FAST PATH	13	IMS
F11	B	099	0028		PC/3600		
F12	B	099	0028		TREND ANALYSIS/370		
M41	B	099	0028		CAPOSS-E		
M51	C	099	0038		370 APT-BP		
M52	B	099	0028		370 APT-IC	LA	
M53	B	099	0028		370 APT-AC	LA	
SM-105	A	2**	3539	S	OS/V5 SORT/MERGE	65	SORT
UT-1	A	2**	3971	S	DASDR	65	
U11	B	099	0028		ENERGY MGMT SYSTEM		
XC2	B	099	0028		DMS/OS/V5		
XE2	B	099	0028	BM	MVS TSO 3270 EXTENDED02		

** - RECORD THE OPERATING SYSTEM OF PROGRAM PRODUCT:
 DQ NQI USE 042 FOR DUS REGARDLESS OF THE RELEASE LEVEL
 OS & OTHER - 01, OS/V51 - 52, SVS - 53, MVS - 55,
 VM/370 - 54, DOS - 02, DOS/V5 - 56

PGM NO.	SVC CLS	FESN BASE	COMP	MAIL ADDR.	PROGRAM TITLE	SUPP CODE	FTSC GROUP
XM1	C	099	0038		GRAPHAGE OS/V5		
XM3	B	099	0028	AR	MPSX/370 OS/V5		PR
XN2	C	099	0038		MDAP		
XP1	B	099	0028	AR	PROJACS OS/V5		PR
XR1	B	099	0028	G	STAIRS/V5		ST
XR2	C	099	0038		RIRMS OS/V5		
XR3	C	099	0038		TGS/7		
XR4	B	099	0028	AR	DECTAT OS/V5		PR
XR-500	A	252	3871	AK	OS/V51 VSPC		13 VSPC
XR-600	A	255	3881	AK	OS/V52 VSPC		13 VSPC
XR-800	A	255	4121	AK	JES 2 NJE		13 JES 2
XR9	B	099	0028		VS TSIO		
XT1	C	099	0038		PSG/TSO		
XT2	B	099	0028		3270 SPF		
XT3	B	099	0028		PSG II/OS/V5		
XT4	B	099	0028		TPNS		
XT5	B	099	0028		PSG II/V5-TSO		
XT6	A	255	3961	BN	TSO CMD PKG	02	TSO
XT7	B	099	0028		QPC ENTRY		
XT8	B	099	0028		TSO 3270 SPF		
XXA	C	099	0038		DB/DC DRIVER SYSTEM		
XXB	B	099	0028	AR	STEPS-PROD OS/V5		PR
XXC	A	2**	3821	CN	TCAM IMS		13 IMS
XX-000	A	2**	3831	CK	TCS-AF		23 TCS
XXF	B	099	0028		DB/DC DATA DICTIONARY		
XX-H00	A	255	3911	BN	RACF	02	RACF
XX-M00	A	255	3591	CG	RMF	02	RMF
XXT	B	099	0028		DB/DC DRIVER SYS		
XXV	B	099	0028		ATMS-II/OS/V5		
XX-100	A	2**	3509	CB	CICS/OS/V5		13 CICS
XX-210	A			AK	IMS/V5 V1 M0 (SEE NOTE 1)		
	A	2**	3519		DATA BASE		13 IMS
	A	2**	3518		DATA COMM		13 IMS
	A	2**	3517		SYSTEM		13 IMS
	A	2**	3516		UTILITIES		13 SEE NOTE 2
	C	099	0028		IQF		
XX-211	A			AK	IMS/V5 V1 M1 (SEE NOTE 1)		
	A	2**	3519		DATA BASE		13 IMS
	A	2**	3518		DATA COMM		13 IMS
	A	2**	3517		SYSTEM		13 IMS
	A	2**	3516		UTILITIES		13 SEE NOTE 2
	C	099	0028		IQF		
XX-214	A			AK	IMS/V5 V1 M4 (SEE NOTE 1)		
	A	2**	3519		DATA BASE		13 IMS
	A	2**	3518		DATA COMM		13 IMS
	A	2**	3517		SYSTEM		13 IMS
	A	2**	3516		UTILITIES		13 SEE NOTE 2
	C	099	0028		IQF		
XX-3	B	099	0028		ATMS/DS		
XX-700	A	2**	3669	AK	GIS/V5		13 IMS
XX-8	B	099	0028	AR	PLANCODE I OS V5		PR
XX-9	B	099	0028	AR	PLANCODE S OS V5		PR
XY-211	A	2**	3842		MSC		13 IMS

NOTE 1: CROSS-REFERENCE MODULE BY SERVICE NUMBER USING
 IMS/V5 SERVICE NUMBER REFERENCE SUMMARY SY25-7722.
 NOTE 2: SEE DB OR DC MICROFICHE AS NECESSARY.

** - RECORD THE OPERATING SYSTEM OF PROGRAM PRODUCT:
 DO NOT USE 042 FOR ODS REGARDLESS OF THE RELEASE LEVEL
 OS & OTHER - 01, OS/V51 - 52, SVS - 53, MVS - 55,
 VM/370 - 54, ODS - 02, ODS/V5 - 56

PAGE OF : G229-2228-20
 REVISED : OCTOBER 1977
 BY TNL : GN25-0005-3

PGM NO.	SVC CLS	FESN BASE	MAIL COMP	PROGRAM ADDR.	TITLE	SUPP CODE	FTSC GROUP

5741- OS/V51 RELEASE 050,060							

SC1-BB	SCP	152 1002	AN	RES/RTAM		02	JOB MGMT
SC1-BC	SCP	152 1003	BN	RES ACCOUNT UTILITY		02	JOB MGMT
SC1-BD	SCP	152 1004	AN	RSTRT RDR/DSDR PROC		02	JOB MGMT
SC1-BE	SCP	152 1005	AN	SYSTEM LOG		02	JOB MGMT
SC1-BF	SCP	152 1006	AN	WTP		02	JOB MGMT
SC1-BG	SCP	152 1007	AN	SCHED INITIALIZATION		02	JOB MGMT
SC1-BJ	SCP	152 1011	AN	JOB LIST MGR		02	JOB MGMT
SC1-BK	SCP	152 1012	AN	ISSP		02	JOB MGMT
SC1-BZ	SCP	152 1026	O	MSS RECOVERY SERV		13	JOB MGMT
SC1-BO	SCP	152 1030	AN	JECS		02	JOB MGMT
SC1-B1	SCP	152 1031	AN	INPUT STREAM CONTROL		02	JOB MGMT
SC1-B2	SCP	152 1032	AN	OUTPUT STREAM CTL		02	JOB MGMT
SC1-B3	SCP	152 1033	AN	SYSTEM RESTART		02	JOB MGMT
SC1-B4	SCP	152 1034	AN	I O DEVICE ALLOC		02	JOB MGMT
SC1-B5	SCP	152 1035	AN	QUEUE MANAGER		02	JOB MGMT
SC1-B6	SCP	152 1036	AN	INITIATOR/DSO		02	JOB MGMT
SC1-B7	SCP	152 1037	AN	TERMINATION		02	JOB MGMT
SC1-B8	SCP	152 1038	AN	COMMANDS		02	JOB MGMT
SC1-B9	SCP	152 1039	AN	INTERPRETER		02	JOB MGMT
SC1-CA	SCP	152 1101	AK	DASD ERP		13	ERP
SC1-CB	SCP	152 1102	AK	UNIT RECORD ERP		13	ERP
SC1-CC	SCP	152 1103	AK	TAPE ERP/VES		13	ERP
SC1-CD	SCP	152 1104	BG	QBR/EREPR/DE		02	ERP
SC1-CE	SCP	152 1105	BG	RMS		02	SUPERVISOR
SC1-CI	SCP	152 1109	O	3851 ERP		13	ERP
SC1-CN	SCP	152 1115	AN	COMMON SUPV MACROS		02	SUPERVISOR
SC1-CP	SCP	152 1117	AN	EXT PREC FLT PT SIM		02	SUPERVISOR
SC1-CS	SCP	152 1122	AK	CONDITIONAL ASM SWTH		13	SUPERVISOR
SC1-C1	SCP	152 1131	AN	IPL		02	SUPERVISOR
SC1-C2	SCP	152 1132	AK	OVERLAY SUPERVISOR		13	SUPERVISOR
SC1-C3	SCP	152 1133	AN	IOS		02	IOS
SC1-C4	SCP	152 1134	BG	DIDOC5		02	DIDOC5
SC1-C5	SCP	152 1135	AN	SUPERVISOR		02	SUPERVISOR
SC1-C7	SCP	152 1137	AK	FETCH		13	SUPERVISOR
SC1-C8	SCP	152 1138	AN	NIP		02	SUPERVISOR
SC1-DB	SCP	152 1202	AK	JES COMPAT INTERFACE		13	DATA MGMT
SC1-DC	SCP	152 1203	AK	PASSWORD PROTECT		13	DATA MGMT
SC1-DD	SCP	152 1204	AK	3505/3525 RDR/PCH SP		02	DATA MGMT
SC1-DE	SCP	152 1205	AK	VSAM		13	DATA MGMT
SC1-DF	SCP	152 1206	AN	3890 DOC PROC		02	DATA MGMT
SC1-DK	SCP	152 1212	AK	IDCAMS		13	DATA MGMT
SC1-DL	SCP	152 1213	AN	3886 OCR		02	DATA MGMT
SC1-DN	SCP	152 1216	AN	3540		02	DATA MGMT
SC1-DP	SCP	152 1217	O	MSS COMMUNICATOR		13	DATA MGMT
SC1-DQ	SCP	152 1218	O	MSC TABLE CREATE		13	DATA MGMT
SC1-DR	SCP	152 1219	O	MSS SPACE MANGE		13	DATA MGMT
SC1-DS	SCP	152 1222	O	MSS DATA ANALYSIS		13	DATA MGMT
SC1-OT	SCP	152 1223	O	MSC TRACE		13	DATA MGMT
SC1-OU	SCP	152 1224	O	MSS SERVICES		13	DATA MGMT
SC1-DO	SCP	152 1230	AK	SAM		13	DATA MGMT
SC1-D1	SCP	152 1231	AK	OPEN/CLOSE/EOV		13	DATA MGMT
SC1-D2	SCP	152 1232	AK	PAM		13	DATA MGMT
SC1-D3	SCP	152 1233	AK	CATALOG		13	DATA MGMT
SC1-D4	SCP	152 1234	AK	DADSM		13	DATA MGMT
SC1-D5	SCP	152 1235	AN	OCR		02	DATA MGMT
SC1-D6	SCP	152 1236	AK	MICR		13	DATA MGMT
SC1-D7	SCP	152 1237	AK	DAH		13	DATA MGMT
SC1-D8	SCP	152 1238	AK	ISAM		13	DATA MGMT
SC1-D9	SCP	152 1239	AK	JAM		13	DATA MGMT
SC1-E1	SCP	152 1241	F	EMUL CONTROL		63	EMULATOR
SC1-G0	SCP	152 1640	CF	GAM		02	BTAM
SC1-I0	SCP	152 1540	S	IBCOMPRS		65	UTILITY
SC1-I1	SCP	152 1541	S	IBCOASDI		65	UTILITY

PGM NO.	SVC CLS	FESN BASE	MAIL COMP	PROGRAM TITLE	SUPP CODE	FTSC GROUP
			ADDR.			
SC1-12	SCP	152	1542	S ICAPRTBL	65	UTILITY
SC1-SS	SCP	152	1322	BX SSS (BASE IND) INTG	03	INDUSTRY SYS
		152	1322	BX SSS (BASE IND) ICR	03	INDUSTRY SYS
SC1-S1	SCP	152	1331	AN SYSGEN	02	SYSGEN
SC1-S2	SCP	152	1332	AN STARTER SYSTEM 3330	02	SYSGEN
SC1-S3	SCP	152	1333	AN STARTER SYSTEM 2314	02	SYSGEN
SC1-S4	SCP	152	1334	AN SUPERVISOR SYSGEN	02	SYSGEN
SC1-S5	SCP	152	1335	AN SCHEDULER SYSGEN	02	SYSGEN
SC1-S6	SCP	152	1336	BG SERVICE AIDS SYSGEN	02	SYSGEN
SC1-UA	SCP	152	1501	S IEBPTPCH	65	UTILITY
SC1-UC	SCP	152	1503	S IEHMOVE	65	UTILITY
SC1-UD	SCP	152	1504	S IEHINIT	65	UTILITY
SC1-UE	SCP	152	1505	S IEHSTATR	65	UTILITY
SC1-UF	SCP	152	1506	S IEHATLAS	65	UTILITY
SC1-UG	SCP	152	1507	AN IEBTCRIN	02	UTILITY
SC1-UH	SCP	152	1508	S IEBISAM	65	UTILITY
SC1-UJ	SCP	152	1511	S IEBDG	65	UTILITY
SC1-UK	SCP	152	1512	S IEBCOMPR	65	UTILITY
SC1-UM	SCP	152	1514	S IEBIMAGE	65	UTILITY
SC1-UX	SCP	152	1527	S SGIEH402	65	UTILITY
SC1-U0	SCP	152	1530	S IEHDASOR	65	UTILITY
SC1-U1	SCP	152	1531	S IEHIOSUP	65	UTILITY
SC1-U2	SCP	152	1532	S IEHLIST	65	UTILITY
SC1-U3	SCP	152	1533	S IEHPRGM	65	UTILITY
SC1-U6	SCP	152	1536	S IEBCOPY	65	UTILITY
SC1-U7	SCP	152	1537	S IEBGENER	65	UTILITY
SC1-U8	SCP	152	1538	S IEBUGDTE	65	UTILITY
SC1-U9	SCP	152	1539	S IEEDIT	65	UTILITY
SC1-OA	SCP	152	1601	AK CRJE	02	CRJE
SC1-OB	SCP	152	1602	AN REL LEVEL ID MACROS	02	SUPVR MACRO
SC1-OC	SCP	152	1603	BX TOLTEP	02	VTAM
SC1-OE	SCP	152	1605	CF POWER WARNING FEAT	02	SUPERVISOR
SC1-O0	SCP	152	1630	AN SCHEDULER SMF	02	JOB MGMT
SC1-O1	SCP	152	1631	BN MAPPING MACROS	02	SUPVR MACRO
SC1-O2	SCP	152	1632	AN SMF	02	JOB MGMT
SC1-O3	SCP	152	1633	S ASSEMBLER XF	65	ASSEMBLER
SC1-O4	SCP	152	1634	AK LINKAGE EDITOR	13	LINK EDIT
SC1-O5	SCP	152	1635	AK LOADER	13	LINK EDIT
SC1-O6	SCP	152	1636	BG DLTEP	02	DLTEP
SC1-O7	SCP	152	1637	CF GSP	02	SUPERVISOR
SC1-O8	SCP	152	1638	AN IVP	02	SYSGEN
SC1-O9	SCP	152	1639	AK CHECK POINT/RESTART	13	JOB MGMT
SC1-10	C	099	0039	DSS	02	
SC1-11	SCP	152	1731	BG GTF	02	SERVICE AID
SC1-12	SCP	152	1732	BG HMASPZAP	02	SERVICE AID
SC1-13	SCP	152	1733	BG HMOPRMP	02	SERVICE AID
SC1-14	SCP	152	1734	AK HMBLIST	13	SERVICE AID
SC1-15	SCP	152	1735	BG HMDSADMP	02	SERVICE AID
SC1-16	SCP	152	1736	BG HMAPTFL	02	SERVICE AID
SC1-17	SCP	152	1737	AN IMCJOBQD	02	SERVICE AID
SC1-18	SCP	152	1738	BG HMOPRMP/EDIT	02	SERVICE AID
SC1-19	SCP	152	1739	AN IMCOSJQD	02	SERVICE AID
SC1-20	SCP	152	1830	CE BTAM	02	BTAM
SC1-21	SCP	152	1831	AL TCAM (LEVELS 8 & 9)	23	TCAM
		152	1832	AL TCAM DIRECT(LEVEL 10)	23	TCAM
SC1-23	SCP	152	1833	BX VTAM	02	VTAM
SC1-24	SCP	152	4012	CM 3600 HOST SUPPORT	02	INDUSTRY SYS
*SC1-26	SCP	152	3183	BU CTS-RETAIL HOST	23	INDUSTRY SYS
*SC1-27	SCP	152	3192	BU CTS-SUPERMARKET HOST	23	INDUSTRY SYS
*SC1-28	SCP	152	3182	AL CTS-SPPS	23	INDUSTRY SYS
SC1-29	SCP	152	1839	BX SPS/KE	02	INDUSTRY SYS
SC1-30	SCP	152	1740	CF HMASMP	02	SMP
SC1-31	SCP	152	1841	AK 3344/3350 AP-1	13	SUPERVISOR

PAGE OF : G229-2228-20
 REVISED : OCTOBER 1977
 BY TNL : GN254-0005-3

PGM NO.	SVC CLS	FESN BASE	MAIL COMP	PROGRAM ADDR.	TITLE	SUPP CODE	FTSC GROUP

5742 - OS/VS2 RELEASE 017							

SC1-B2	SCP	153 1026	O	MSS REC SERVICE		13	
SC1-B2	SCP	153 0142	AK	SYSDOUT WRITER		13	JOB MGMT
SC1-B3	SCP	153 0143	AX	SYSTEM RESTART		02	JOB MGMT
SC1-B4	SCP	153 0144	AX	ALLOCATION		02	JOB MGMT
SC1-B5	SCP	153 0145	AX	QUEUE MANAGER		02	JOB MGMT
SC1-B6	SCP	153 0146	AX	INITIATOR		02	JOB MGMT
SC1-B7	SCP	153 0240	AX	TERMINATION		02	JOB MGMT
SC1-B8	SCP	153 0147	AX	COMMANDS		02	JOB MGMT
SC1-B9	SCP	153 0148	AX	INTERPRETER		02	JOB MGMT
SC1-CA	SCP	153 0165	AK	DASD ERP		13	ERP
SC1-CB	SCP	153 0166	AK	UNIT RECORD ERP		13	ERP
SC1-CC	SCP	153 0167	AK	TAPE ERP/VES		13	ERP
SC1-CD	SCP	153 0168	BG	OBR/EREP/RDE		02	ERP
SC1-CE	SCP	153 0169	BG	RMS		02	SUPERVISOR
SC1-CF	SCP	153 0135	BG	EXTENDED SERVICE RTR		02	SUPERVISOR
SC1-CI	SCP	153 1109	O	MSS 3851 ERP		13	ERP
SC1-CN	SCP	153 0241	BG	COMMON SUPV MACROS		02	SUPERVISOR
SC1-CP	SCP	153 0242	AN	EXT PREC FLT PT SIM		02	SUPERVISOR
SC1-CS	SCP	153 0119	AK	CONDITIONAL ASM SWTH		13	SUPERVISOR
SC1-CT	SCP	153 0243	BN	BLDL LIST		02	SUPERVISOR
SC1-C1	SCP	153 0131	BG	IPL		02	SUPERVISOR
SC1-C2	SCP	153 0132	AK	OVERLAY SUPERVISOR		13	SUPERVISOR
SC1-C3	SCP	153 0133	AK	IOS		13	IOS
SC1-C4	SCP	153 0134	BG	DIDDCS		02	DIDDCS
SC1-C5	SCP	153 0244	BG	SUPERVISOR		02	SUPERVISOR
SC1-C7	SCP	153 0137	AK	FETCH		13	SUPERVISOR
SC1-DC	SCP	153 0154	AK	PASSWORD PROTECT		13	DATA MGMT
SC1-DD	SCP	153 0158	AK	3505/3525 RDR/PCH SP		02	DATA MGMT
SC1-DE	SCP	153 0157	AK	VSAM		13	DATA MGMT
SC1-DK	SCP	153 0159	AK	IDCAMS		13	DATA MGMT
SC1-DP	SCP	153 1217	O	MSS COMMUNICATOR		13	DATA MGMT
SC1-DQ	SCP	153 1218	O	MSS TABLE CREATE		13	DATA MGMT
SC1-DR	SCP	153 1219	O	MSS SPACE MGT		13	DATA MGMT
SC1-DS	SCP	153 1222	O	MSS DATA ANALYSIS		13	DATA MGMT
SC1-DT	SCP	153 1223	O	MSS TRACE		13	DATA MGMT
SC1-DO	SCP	153 1224	O	MSS SERVICES		13	DATA MGMT
SC1-DO	SCP	153 0153	AK	SAM		13	DATA MGMT
SC1-O1	SCP	153 0152	AK	OPEN/CLOSE/EOV		13	DATA MGMT
SC1-O2	SCP	153 0246	AK	PAM		13	DATA MGMT
SC1-O3	SCP	153 0245	AK	CATALOG		13	DATA MGMT
SC1-O4	SCP	153 0247	AK	DADSM		13	DATA MGMT
SC1-O5	SCP	153 0248	AN	OCR		02	DATA MGMT
SC1-O6	SCP	153 0249	AK	MICR		13	DATA MGMT
SC1-O7	SCP	153 0250	AK	DAM		13	DATA MGMT
SC1-O8	SCP	153 0151	AK	ISAM		13	DATA MGMT
SC1-G0	SCP	153 0155	CF	GAM		02	BTAM
SC1-I0	SCP	153 0123	S	IBCOMPRS		65	UTILITY
SC1-I1	SCP	153 0251	S	IBCDASDI		65	UTILITY
SC1-I2	SCP	153 0252	S	ICAPRTBL		65	UTILITY
SC1-SS	SCP	153 1322	BX	SSS (BASE IND SUPT)		03	INDUSTRY SYS
SC1-S1	SCP	153 0117	AK	SYSGEN		13	SYSGEN
SC1-S2	SCP	153 0112	AK	STARTER SYSTEM 3330		13	SYSGEN
SC1-S3	SCP	153 0111	AK	STARTER SYSTEM 2314		13	SYSGEN
SC1-S4	SCP	153 0253	AK	SUPERVISOR SYSGEN		02	SYSGEN
SC1-S5	SCP	153 0254	AX	SCHEDULER SYSGEN		02	SYSGEN
SC1-S6	SCP	153 0255	BG	SERVICE AIDS SYSGEN		02	SYSGEN
SC1-T0	SCP	153 0181	AX	TSO EDIT		02	TSO
SC1-T1	SCP	153 0182	AX	TSO TEST		02	TSO
SC1-T2	SCP	153 0256	AX	TSO UTILITIES		23	TSO
SC1-T3	SCP	153 0183	AX	TSO DATA MANAGEMENT		23	TSO
SC1-T4	SCP	153 0184	AX	TSO SCHEDULER		02	TSO

PGM NO.	SVC	FESH	MAIL	PROGRAM TITLE	SUPP	FTSC
NO.	CLS	BASE	COMP	ADDR.	CODE	GROUP
SC1-T5	SCP	153	0185	AK LINK LOADGO PROMPTER	13	TSO
SC1-T7	SCP	153	0187	AX TSO SUPERVISOR	02	TSO
SC1-T8	SCP	153	0188	AL TSO TCAM SUBROUTINE	23	TSO TCAM
SC1-T9	SCP	153	0189	AX TSO TRACE	02	TSO
SC1-UA	SCP	153	0122	S IEBPTPCH	65	UTILITY
SC1-UC	SCP	153	0121	S IEHMOVE	65	UTILITY
SC1-UD	SCP	153	0257	S IEHINITT	65	UTILITY
SC1-UE	SCP	153	0258	S IEHSTATR	65	UTILITY
SC1-UF	SCP	153	0259	S IEHATLAS	65	UTILITY
SC1-UG	SCP	153	0260	AN IEBTCRIN	02	UTILITY
SC1-UH	SCP	153	0261	S IEBISAM	65	UTILITY
SC1-UJ	SCP	153	0262	S IEBDBG	65	UTILITY
SC1-UK	SCP	153	0263	S IEBCOMPR	65	UTILITY
SC1-UM	SCP	153	1514	S IEBIMAGE	65	UTILITY
SC1-UX	SCP	153	0116	S SGIH402	65	UTILITY
SC1-U0	SCP	153	0264	S IEHDASDR	65	UTILITY
SC1-U2	SCP	153	0265	S IEHLIST	65	UTILITY
SC1-U3	SCP	153	0266	S IEHPRGM	65	UTILITY
SC1-U6	SCP	153	0267	S IEBCOPY	65	UTILITY
SC1-U7	SCP	153	0268	S IEBGENER	65	UTILITY
SC1-U8	SCP	153	0269	S IEBUPDTE	65	UTILITY
SC1-U9	SCP	153	0270	S IEBEDIT	65	UTILITY
SC1-0B	SCP	153	0271	BN REL LEVEL ID MACROS	02	SUPVR MACRO
SC1-0C	SCP	153	1603	BX TOLTEP	02	VTAM
SC1-0E	SCP	153	0150	CF POWER WARNING FEAT	02	SUPERVISOR
SC1-00	SCP	153	0138	AX SCHEDULER SMF	02	JOB MGMT
SC1-01	SCP	153	0272	BN MAPPING MACROS	02	SUPVR MACRO
SC1-02	SCP	153	0273	AX SMF	02	JOB MGMT
SC1-03	SCP	153	0113	S ASSEMBLER XF	65	ASSEMBLER
SC1-04	SCP	153	0114	AK LINKAGE EDITOR	13	LINK EDIT
SC1-05	SCP	153	0115	AK LOADER	13	LINK EDIT
SC1-06	SCP	153	0161	BG QLTEP	02	QLTEP
SC1-07	SCP	153	0156	CF GSP	02	SUPERVISOR
SC1-08	SCP	153	0118	BR IVP	02	SYSGEN
SC1-09	SCP	153	0136	AK CHECK POINT/RESTART	13	JOB MGMT
SC1-10	C	099	0039	DSS	02	
SC1-11	SCP	153	0163	BG GTF	02	SERVICE AID
SC1-12	SCP	153	0164	BG AMASPZAP	02	SERVICE AID
SC1-13	SCP	153	0274	BG AMDPROMP	02	SERVICE AID
SC1-14	SCP	153	0275	AK AMBLIST	13	SERVICE AID
SC1-15	SCP	153	0276	BG AMDSADMP	02	SERVICE AID
SC1-16	SCP	153	0277	BG AMAPTFLE	02	SERVICE AID
SC1-18	SCP	153	0273	BG AMDPROMP/EDIT	02	SERVICE AID
SC1-20	SCP	153	0176	CE BTAM	02	BTAM
SC1-21	SCP	153	1831	AL TCAM (LEVEL 5)	23	TCAM
		153	1832	AL TCAM DIRECT(LEVEL 10)	23	TCAM
SC1-22	SCP	153	0172	BG 3735 MACROS/UTILITY	23	BTAM
SC1-23	SCP	153	1833	BX VTAM	03	VTAM
SC1-30	SCP	153	0230	CF HMASMP	02	SMP
SC1-31	SCP	153	1841	AK 3344/3350 AP-1	13	SUPERVISOR

 5743

SM-103 C 099 0038 DOS SORT/MERGE 3330

PAGE OF : G229-2228-20
 REVISED : OCTOBER 1977
 BY TNL : GN25-0005-3

PGM NO.	SVC CLS	FESN BASE	MAIL COMP	MAIL ADDR.	PROGRAM TITLE	SUPP CODE	FTSC GROUP

5744							

AA1	SCP	151	0809	AF	OS/V5 MACLIB/R		27
AB1	SCP	151	0819	AF	OS/V5 ASM/7		27
AC1	SCP	151	0829	AF	OS/V5 LINK/7		27
AD1	SCP	151	0839	AF	OS/V5 FORNAT/7		27

*THE FOLLOWING 5744 PID NUMBERS ARE FOR OS/V5 *							

AE1	SCP	152	2051		1285/1287/1288 DM		DATA MGMT
AG1	SCP	1**	2071	F	1410 EMULATOR	63	EMULATOR
AH1	SCP	1**	2081	F	1401 EMULATOR	63	EMULATOR
AJ1	C	099	0038		155,158/7074 EMUL		
AK1	C	099	0038		165,168/7074 EMUL		
AL1	C	099	0038		165,168/7080 EMUL		
AM1	C	099	0038		165,168/7094 EMUL		
AN1	SCP	1**	2151	AL	3705 SSP FOR OS/V5	23	3705 PROG
AS1	SCP	1**	2221	F	DOS EMULATOR	63	EMULATOR
AZ1	SCP	152	2291	BG	3735 MACROS & UTIL	23	BTAM
IBJ1	C	099	0038		OS/V51 DISK COPY PRGG		
BK1	SCP	152	3121	CF	DIST INTEL SYS	02	INDUSTRY SYS
IBL1	C	099	0038		OS/V52 DISK COPY PRGG		
BQ2	SCP	1**	3182	AL	CTS SPPS	23	INDUSTRY SYS
BQ3	SCP	152	3183	BU	CTS RETAIL HOST	23	INDUSTRY SYS
BQ4	SCP	155	3183	BU	CTS RETAIL HOST	23	INDUSTRY SYS
BR2	SCP	1**	3192	BU	CTS SUPERMARKET HOST	23	INDUSTRY SYS
BZ1	SCP	152	3291	BT	3790 HOST SUPPORT	02	INDUSTRY SYS
BZ2	SCP	155	3291	BT	3790 HOST SUPPORT	02	INDUSTRY SYS
BZ3	SCP	1**	3291	BT	3790 HOST SUPPORT	02	INDUSTRY SYS
CA3	SCP	1**	4012	CM	3600 HOST SUPPORT	02	INDUSTRY SYS
CG1	SCP	152	4071	H	BATCH TRANSFER PRGG	03	INDUSTRY SYS
CG2	SCP	155	4072	H	BATCH TRANSFER PRGG	03	INDUSTRY SYS
CH1	SCP	153	4073	H	BATCH TRANSFER PRGG	03	INDUSTRY SYS

** - RECORD THE OPERATING SYSTEM OF THE COMPONENT:
 OS/V51 - 52, SVS - 53, MVS - 55.

PGM NO.	SVC CLS	FESN BASE	MAIL COMP	ADDR.	PROGRAM TITLE	SUPP CODE	FTSC GROUP

*5745-DOS/V5 RELEASE 320, 330, 340, 701 *							

* FOR SCP RECORD BASE OF 156. *							
* DOS/V5 ADVANCED FUNCTION IS A PROGRAM PRODUCT. *							
* FOR ADVANCED FUNCTION COMPONENTS RECORD BASE 256. *							
* RECORD LEVEL 701 IN THE RELEASE BLOCK OF THE PSAR *							
* AND COMPONENT LEVEL BLOCK OF THE APAR WHEN WORKING *							
* ON ADVANCED FUNCTION COMPONENTS. *							
* USE THE BASE SCP COMPONENT ID'S WHEN SUBMITTING *							
* APARS. DO NOT SUBMIT APAR AGAINST 5746 COMPONENT ID*							

SC-AIT	SCP	***	0132	H	ATTENTION ROUTINES	02	SUPERVISOR
SC-AMS	SCP	156	0122	AK	VSAM SERVICE PROG	13	LIOCS
SC-APC	SCP	156	1841	AK	3344/3350 AP-1	13	SUPERVISOR
SC-ASM	SCP	156	0137	S	ASSEMBLER PHK	02	ASSEMBLER
SC-BTM	SCP	156	0171	CE	BTAM	23	BTAM
SC-CKR	SCP	156	0133	H	CHECKPOINT/RESTART	02	SUPERVISOR
SC-DAM	SCP	156	0152	H	DIR ACC METHOD	02	LIOCS
SC-DIO	SCP	156	0153	AN	DISKETTE IOCS	02	LIOCS
SC-DIS	SCP	156	0123	H	DISTRIBUTION PROGRAM	02	SUPERVISOR
SC-DKE	SCP	156	0166	H	DISK ERP	02	SUPERVISOR
SC-DOC	SCP	***	0138	H	DISP OPER CONSOLE	02	SUPERVISOR
SC-DSK	SCP	156	0153	H	SEQUENT DISK I/O	02	LIOCS
*SC-EML	SCP	156	0181	F	1401/1410 EMULATOR	02	EMULATOR
SC-ERP	SCP	156	0165	H	EREP	02	SUPERVISOR
SC-E20	SCP	156	0182	F	MOD 20 EMULATOR	02	EMULATOR
SC-IOM	SCP	156	0154	H	COMP I/O MODULES	02	LIOCS
SC-IOX	SCP	156	0155	H	IOCS/DEV IND I/O	02	LIOCS
SC-IPL	SCP	***	0134	H	IPL BUFFER LOAD	02	SUPERVISOR
SC-ISM	SCP	156	0156	H	INDEX SEQ FILE MGMT	02	LIOCS
SC-JCL	SCP	***	0141	H	JOB CONTROL	02	JOB CONTROL
SC-LBR	SCP	***	0135	H	LIB, SERV AND MAINT	02	SUPERVISOR
			156	0135	G COPYSERV (R330 ONLY)	02	SUPERVISOR
SC-LNK	SCP	***	0136	H	LINKAGE EDITOR	02	JOB CONTROL
SC-MCR	SCP	156	0157	H	MCR IOCS	02	LIOCS
SC-OCR	SCP	156	0158	AN	OCR IOCS	02	LIOCS
SC-OLT	SCP	156	0161	BG	OLTEP	02	SUPERVISOR
SC-PDA	SCP	***	0163	H	PD AIDS	02	SERVICE AID
SC-PTP	SCP	156	0154	H	PAPER TAPE IOCS	02	LIOCS
SC-PWR	SCP	156	0143	H	POWER/V5	02	POWER
SC-QTM	SCP	156	0172	CE	QTAM	23	QTAM
SC-RMS	SCP	156	0164	H	RMSR	02	SUPERVISOR
*SC-RTL	SCP	156	3183	BU	CTS RETAIL HOST	23	INDUSTRY SYS
*SC-SMK	SCP	156	3192	BU	CTS SUPERMARKET HOST	23	INDUSTRY SYS
*SC-SPP	SCP	156	3182	AL	CTS-SPPS	23	INDUSTRY SYS
*SC-SSS	SCP	156	0190	BX	SSS (BASE IND SUPT)	02	INDUSTRY SYS
SC-SUP	SCP	***	0131	H	SUPERVISOR	02	SUPERVISOR
SC-TAP	SCP	156	0159	H	MAG TAPE IOCS	02	LIOCS
SC-TLT	SCP	156	0162	BX	TOLTEP	02	VTAM
SC-TPE	SCP	156	0167	H	TAPE ERP	02	SUPERVISOR
SC-UTL	SCP	156	0121	H	SYSTEM UTILITIES	02	UTILITY
			156	0121	G BACKUP (IJWSABK)	02	UTILITY
			156	0121	G RESTORE (IJWSARST)	02	UTILITY
			156	0121	H OBJMAINT	02	UTILITY
SC-UTS	SCP	156	0124	G	MAINTAIN SYS HIST	02	SUPERVISOR
SC-VSM	SCP	156	0151	G	VSAM	13	LIOCS
SC-VTM	SCP	156	0173	BX	VTAM	02	VTAM
SC-124	SCP	156	1181	CM	3600 HOST SUPPORT	02	INDUSTRY SYS

*** INDICATES COMPONENTS AFFECTED BY ADVANCED FUNCTION.
 * INDEPENDENT RELEASE - NOT INTEGRATED WITH BASE SYSTEM.

PGM NO.	SVC CLS	FESN BASE	MAIL COMP	PROGRAM TITLE	SUPP CODE	FTSC GROUP
			ADDR.			

5746-DOS/VS PP						

CB-100	A	256	3569	G DOS/VS FULL CBL/LIB	64	COBOL DOS

* THESE ARE THE COMPONENTS OF DOS/VS ADVANCED FUNCTION *						
*E2-AIT	A	256	0132	* ATTENTION ROUTINES	02	SUPERVISOR
*E2-DOC	A	256	0138	* OISP OPER CONSOLE	02	SUPERVISOR
*E2-IPL	A	256	0134	* IPL BUFFER LOAD	02	SUPERVISOR
*E2-JCL	A	256	0141	* JOB CONTROL	02	JOB CONTROL
*E2-LBR	A	256	0135	* LIB,SERV AND MAINT	02	SUPERVISOR
*E2-LNK	A	256	0136	* LINKAGE EDITOR	02	JOB CONTROL
*E2-PDA	A	256	0163	* PD AIDS	02	SERVICE AID
*E2-SUP	A	256	0131	* SUPERVISOR	02	SUPERVISOR
* FOR APAR REPORTING USE THE CORRESPONDING 5745 COMPO- *						
* NENT ID AND MAILING ADDRESS. RECORD LEVEL 701 IN THE *						
* RELEASE BLOCK OF THE PSAR AND THE COMPONENT LEVEL *						
* BLOCK OF THE APAR FORM. *						
* DO NOT APAR THE 5746 COMPONENTS--USE THE *						
* CORRESPONDING 5745 COMPONENTS FOR APAR PURPOSES *						

F11	B	099	0029	PROG CUSTOMIZER		
F12	B	099	0029	DOSCHECK		
F31	C	099	0039	BASE VER 3		
F51	C	099	0038	BUDPLAN DOS/VS		
H12	C	099	0038	HCS/LIS		
H13	C	099	0038	HCS/DATA COMM		
H14	B	099	0028	N HCS/ACCTG SYS		WP
LM-302	A	256	3439	AK FORT 4 LIB DOS 3330	13	FORTAN
LM-400	A	256	3569	G DOS/VS FULL LIB	02	COBOL
M41	B	099	0028	CAPOSS-E		
N11	B	099	0029	LIFE INQ/DATA ENTRY		
RG-100	A	256	1278	G RPG II COMPILER	64	RPG
SM-104	A	256	3529	S DOS/VS SORT/MERGE	65	SORT DOS
SM-200	A	256	3528	S DOS/VS SORT/MERGE	65	SORT DOS
XC2	B	099	0028	DMS/DOS/VS		
XM1	C	099	0038	GRAPHAGE DOS/VS		
XM2	B	099	0028	AR MPSX/370 DOS/VS		PR
XN1	B	099	0028	AR APT-BC DOS/VS		PR
XN2	C	099	0038	DOS/VS MDAP		
XP1	B	099	0028	AR PROJACS DOS/VS		PR
XR1	C	099	0038	RIRMS DOS/VS		
XR2	B	099	0028	AR DECTAT DOS/VS		PR
XR-300	A	256	3891	AK DOS/VS VSPC	13	VSPC
XR4	B	099	0028	STAIRS/DOS/VS		
XT1	B	099	0028	PSG II/DOS/VS		
XXA	B	099	0028	AR PLANCODE S DOS VS		PR
XX-800	A	256	3498	CI CICS DOS VS EXTM	13	CICS
XXC	B	099	0028	DB/OC DATA DICTIONARY		
XXG	B	099	0028	ATMS-II/DOS/VS		
XX-100	A	256	3469	G DL/I DOS	13	DLI
XX2	B	099	0029	AR STEPS PROD DOS/VS		PR
XX-300	A	256	3499	CB CICS/DOS/VS	13	CICS DOS
XX-400	B	099	0029	ATMS/DOS/VS		
XX-700	A	256	3689	G DL/I ENTRY DOS/VS	13	DLI
XX9	B	099	0029	AR PLANCODE/I DOS/VS		PR

PGM NO.	SVC CLS	FESN BASE	MAIL COMP	MAIL ADDR.	PROGRAM TITLE	SUPP CODE	FTSC GROUP

5747-SYS/7 & DOS/V5							

AB1	SCP	151	0469	AF	DOS/V5 ASM/7	27	
AC1	SCP	151	0479	AF	DOS/V5 LINK/7	27	
AD1	SCP	151	0489	AF	DOS/V5 FORMAT/7	27	
AE1	SCP	151	0499	AF	DOS/V5 MACLIB/R	27	
AF1	SCP	151	0609	AF	DOS/V5 MSP/7 HPPF	27	
AG1	SCP	156	2151	AL	3705 SSP FOR DOS/V5	23	3705 PROG
AZ1	SCP	156	1029	BG	3735 MACROS & UTIL	23	BTAM
BQ1	SCP	156	1171	BT	3790 HOST SUPPORT	02	INDUSTRY SYS
BR1	SCP	156	1181	CM	3600 HOST SUPPORT	02	INDUSTRY SYS
BW1	SCP	156	1191	H	BATCH TRANSFER PROG	03	INDUSTRY SYS
CC3	SCP	156	0181	F	14XX/7010 EMULATOR	63	EMUL
CC6	SCP	156	0190	BX	SSS LEVEL 4	03	INDUSTRY SYS

5748-PP							

AP-101	A	2**	3809	AK	VS APL	13	APL
FO-211	A	2**	3819	AK	VSPC FORTRAN	13	FORTRAN
H11	B	099	0029		NEW HEALTH CARE		
XT2	B	099	0028		PSG II/V5-CMS		
XX-111	A	2**	3699	AK	VS/BASIC	13	BASIC
XX3	B	099	0028		DL/I BRIDGE		
XX4	B	099	0028		DATA BASE DESIGN AID		
XX6	B	099	0028		IIS		

5749-VM/370 - RELEASE 2, 3							

DMK	SCP	154	0429	AG	VM/370 CP	02	VM 370
DMM-00	SCP	154	0709	AG	IPCS	02	VM 370
DMS	SCP	154	0679	AS	VM/370 CMS	02	VM 370
DMT	SCP	154	0689	AG	VM/370 RSCS	02	VM 370
SC-10D	SCP	154	0729	BG	EREP	02	
SC-103	SCP	154	0699	S	VM/370 ASSEMBLER	65	ASSEMBLER

*5752-OS/V52 RELEASE 030, 037 *							

REFERENCE TOOLS (SEE PLM SECTION)							
SYSTEM FICHE INDEX (SEE PLM SECTION)							
BD-TST	SCP	155	1040	BR	DLIB LOADY/INSTALL	02	
SC1-BA	SCP	155	1001	AK	JES 3	13	JES 3
SC1-BH	SCP	155	1008	AK	JES 2	13	JES 2
SC1-BN	SCP	155	1015	BN	SYSTEM SECURITY SUPT	02	
SC1-B2	SCP	155	1026	D	MSS RECOVERY SERV	13	
SC1-B2	SCP	155	1032	AK	EXTERNAL WRITER	13	JOB MGMT
SC1-B3	SCP	155	1033	BN	SCHEDULER RESTART	02	JOB MGMT
SC1-B4	SCP	155	1034	BN	ALLOC/UNALLOC/VAC	02	JOB MGMT
SC1-B5	SCP	155	1035	BN	SWA MANAGER	02	JOB MGMT
SC1-B6	SCP	155	1036	BN	INITIATOR TERMINATOR	02	JOB MGMT
SC1-B8	SCP	155	1038	BN	M S COMMANDS	02	JOB MGMT
SC1-B9	SCP	155	1039	BN	CONVERTER/INTERPRETER	02	JOB MGMT
SC1-CA	SCP	155	1101	AK	DASD ERP	13	ERP
SC1-CB	SCP	155	1102	AK	U R ERP	13	ERP
SC1-CC	SCP	155	1103	AK	TAPE/ ERP/VES	13	ERP
SC1-CD	SCP	155	1104	BG	OBR/EREP/RDE	02	ERP
SC1-CE	SCP	155	1105	BN	RMS	02	SUPERVISOR
SC1-CF	SCP	155	1106	BN	EXTENDED SVC ROUTER	02	SUPERVISOR
SC1-CG	SCP	155	1107	BN	SVC 109	02	SUPERVISOR
SC1-CH	SCP	155	1108	BN	VIRT STOR MANGR	02	SUPERVISOR
** - RECORD THE OPERATING SYSTEM OF PROGRAM PRODUCT:							
DD NOT USE 042 FOR DOS REGARDLESS OF THE RELEASE LEVEL							
OS & OTHER - 01, OS/V51 - 52, OS/V52 (REL. 1.X) - 53,							
OS/V52 (REL. 2 & ABOVE) - 55, VM/370 - 54, DOS - 02,							
DOS/V5 - 56							

PAGE DF : G229-2228-20
 REVISED : OCTOBER 1977
 BY TNL : GN25-0005-3

PGM NO.	SVC CLS	FESN BASE	MAIL CGMP	PROGRAM ADDR.	TITLE	SUPP CODE	FTSC GROUP
SC1-CI	SCP	155	1109	0	3851 DSM ERP	13	ERP
SC1-CJ	SCP	155	1111	BN	CONTENTS SUPERVISOR	02	SUPERVISOR
SC1-CK	SCP	155	1112	BN	COMM TASK	02	SUPERVISOR
SC1-CL	SCP	155	1113	BN	TASK MANAGER	02	SUPERVISOR
SC1-CM	SCP	155	1114	BN	RECOVERY TERMINATION	02	SUPERVISOR
SC1-CP	SCP	155	1117	AN	EXT PREC FLT PNT	02	SUPERVISOR
SC1-CQ	SCP	155	1118	CG	MF/1	02	SUPERVISOR
SC1-CR	SCP	155	1119	BN	REAL STOR MANAGER	02	SUPERVISOR
SC1-CU	SCP	155	1124	BN	REGION CONTROL TASK	02	SUPERVISOR
SC1-CV	SCP	155	1125	BN	TIMER SUPERVISOR	02	SUPERVISOR
SC1-CW	SCP	155	1126	BN	AUX STOR MANAGER	02	SUPERVISOR
SC1-CX	SCP	155	1127	CG	SYSTEM RESOURCE MGR	02	SUPERVISOR
SC1-CY	SCP	155	1128	BS	RADIX PARTITION TREE	02	SUPERVISOR
SC1-CZ	SCP	155	1129	BN	MP RECONFIGURATION	02	SUPERVISOR
SC1-C2	SCP	155	1132	AK	OVERLAY SUPERVISOR	13	SUPERVISOR
SC1-C3	SCP	155	1133	BN	IDS	02	IGS
SC1-C4	SCP	155	1134	BN	DIDOC5	02	DIDOC5
SC1-C5	SCP	155	1135	BN	SUPERVISOR CONTROL	02	SUPERVISOR
SC1-C6	SCP	155	1136	BN	EXCP	02	SUPERVISOR
SC1-C7	SCP	155	1137	AK	FETCH	13	SUPERVISOR
SC1-C6	SCP	155	1138	BN	NIP	02	SUPERVISOR
SC1-C9	SCP	155	1139	BN	IPL	02	SUPERVISOR
SC1-DA	SCP	155	1201	AK	BLOCK PROCESSOR	13	DATA MGMT
SC1-DB	SCP	155	1202	AK	SAM SUBSYSTEM INTERFACE	13	DATA MGMT
SC1-DC	SCP	155	1203	AK	PASSWORD PROTECT	13	DATA MGMT
SC1-DD	SCP	155	1204	AK	3505/3525 RDR/PCH	02	DATA MGMT
SC1-DE	SCP	155	1205	AK	VSAM & VSAM CATALOG	13	DATA MGMT
SC1-DF	SCP	155	1206	AN	369G DOCUMNT PROCESSOR	02	DATA MGMT
SC1-DG	SCP	155	1207	AK	VBP	13	DATA MGMT
SC1-DH	SCP	155	1208	AK	CATALOG CNTRLR 3	13	DATA MGMT
SC1-DJ	SCP	155	1211	AK	WINDOW INTERCEPT	13	DATA MGMT
SC1-DK	SCP	155	1212	AK	ACCESS METHOD SERVICE	13	DATA MGMT
SC1-DL	SCP	155	1213	AN	3886 OCR	02	DATA MGMT
SC1-DN	SCP	155	1215	AN	3540	02	DATA MGMT
SC1-DP	SCP	155	1217	0	MSS COMMUNICATOR	13	DATA MGMT
SC1-DQ	SCP	155	1218	0	MSC TABLE CREATE	13	DATA MGMT
SC1-DR	SCP	155	1219	0	MSS SPACE MANGE	13	DATA MGMT
SC1-DS	SCP	155	1222	0	MSS DATA ANALYSIS	13	DATA MGMT
SC1-DT	SCP	155	1223	0	MSC TRACE	13	DATA MGMT
SC1-DU	SCP	155	1224	0	MSS SERVICES	13	DATA MGMT
SC1-DC	SCP	155	1230	AK	SAM	13	DATA MGMT
SC1-DI	SCP	155	1231	AK	O/C/EOV	13	DATA MGMT
SC1-D2	SCP	155	1232	AK	PAM	13	DATA MGMT

PGM NO.	SVC CLS	FESN BASE	MAIL COMP	MAIL ADDR.	PROGRAM TITLE	SUPP CODE	FTSC GROUP
SC1-D4	SCP	155	1234	AK	DADSM	13	DATA MGMT
SC1-D5	SCP	155	1235	AN	OCR	02	DATA MGMT
SC1-D6	SCP	155	1236	AK	MICR	13	DATA MGMT
SC1-D7	SCP	155	1237	AK	DAM	13	DATA MGMT
SC1-D8	SCP	155	1238	AK	ISAM	13	DATA MGMT
SC1-E1	SCP	155	1241	F	EMUL CONTROL	63	EMULATOR
SC1-G0	SCP	155	1640	CF	GAM	02	BTAM
SC1-I0	SCP	155	1540	S	IBCDMPRS	65	UTILITY
SC1-I1	SCP	155	1541	S	IBCDASDI	65	UTILITY
SC1-I2	SCP	155	1542	S	ICAPRTBL	65	UTILITY
SC1-S5	SCP	155	1322	BX	SSS (BASE IND SUPT)	03	INDUSTRY SYS
SC1-S1	SCP	155	1331	AK	SYSGEN	13	SYSGEN
SC1-S2	SCP	155	1332	AK	3330 STARTER	02	SYSGEN
SC1-S3	SCP	155	1333	AK	2314 STARTER	02	SYSGEN
SC1-S4	SCP	155	1334	BN	SUPERVISOR SYSGEN	02	SYSGEN
SC1-S5	SCP	155	1335	BN	SCHEDULER SYSGEN	02	SYSGEN
SC1-S6	SCP	155	1336	BG	SERVICE AIDS SYSGEN	02	SYSGEN
SC1-T0	SCP	155	1430	BN	TSO EDIT	02	TSO
SC1-T1	SCP	155	1431	BN	TSO TEST	02	TSO
SC1-T2	SCP	155	1432	AX	TSO UTILITIES	23	TSO
SC1-T3	SCP	155	1433	AX	TSO TIOC	23	TSO
SC1-T4	SCP	155	1434	BN	TSO SCHEDULER	02	TSO
SC1-T5	SCP	155	1435	AK	LINK LOADGO PROMPTER	13	TSO
SC1-T8	SCP	155	1438	AL	TSO TCAM SUBROUTINES	23	TSO TCAM
SC1-T9	SCP	155	1439	BX	VTIOC/TCAS	02	TSO
SC1-UA	SCP	155	1501	S	IEBTPCH	65	UTILITY
SC1-UC	SCP	155	1503	S	IEHMOVE	65	UTILITY
SC1-UD	SCP	155	1504	S	IEHINIT	65	UTILIT
SC1-UE	SCP	155	1505	S	IEHSTATR	65	UTILITY
SC1-UF	SCP	155	1506	S	IEHATLAS	65	UTILITY
SC1-UG	SCP	155	1507	AN	IEBTGRIN	02	UTILITY
SC1-UH	SCP	155	1508	S	IEBISAM	65	UTILITY
SC1-UJ	SCP	155	1511	S	IEBDG	65	UTILITY
SC1-UK	SCP	155	1512	S	IEBCOMPR	65	UTILITY
SC1-UM	SCP	155	1514	S	IEBIMAGE	65	UTILITY
SC1-UX	SCP	155	1527	S	SGIEH402	65	UTILITY
SC1-UY	SCP	155	1528	CL	IEHUCAT	02	UTILITY
SC1-U0	SCP	155	1530	S	IEHDASDR	65	UTILITY
SC1-U2	SCP	155	1532	S	IEHLIST	65	UTILITY
SC1-U3	SCP	155	1533	S	IEHPRGDM	65	UTILITY
SC1-U6	SCP	155	1536	S	IEBCOPY	65	UTILITY
SC1-U7	SCP	155	1537	S	IEBGENER	65	UTILITY
SC1-U8	SCP	155	1538	S	IEBUPDTE	65	UTILITY
SC1-U9	SCP	155	1539	S	IEBEDIT	65	UTILITY
SC1-OC	SCP	155	1603	BX	TOLTEP	02	VTAM
SC1-OE	SCP	155	1605	BN	POWER WARNING FEATURE	02	SUPERVISOR
SC1-O0	SCP	155	1630	BN	SMF SCHEDULER	02	JOB MGMT
SC1-O1	SCP	155	1631	BR	MAPPING/SUPVSR	MACROS	SUPVR MACRO
SC1-O2	SCP	155	1632	BN	SMF	02	JOB MGMT
SC1-O3	SCP	155	1633	S	ASSEMBLER XF	65	ASSEMBLER
SC1-O4	SCP	155	1634	AK	LINKAGE EDITOR	13	LINK EDIT
SC1-O5	SCP	155	1635	AK	LOADER	13	LINK EDIT
SC1-O6	SCP	155	1636	BG	OLTEP	02	OLTEP
SC1-O7	SCP	155	1637	CF	GSP	02	SUPERVISOR
SC1-O8	SCP	155	1638	BR	IYP	02	SUPERVISOR
SC1-O9	SCP	155	1639	AK	CHKPT/RSTRT	13	JOB MGMT
SC1-10	C	099	0039		DSS	02	
SC1-11	SCP	155	1731	BG	GTF	02	SERVICE AID
SC1-12	SCP	155	1732	BG	AMASPZAP	02	SERVICE AID
SC1-13	SCP	155	1733	BG	AMDPRDMP	02	SERVICE AID

PAGE OF : G229-2228-20
 REVISED : OCTOBER 1977
 BY TNL : GN25-0005-3

PGM NO.	SVC CLS	FESN BASE	MAIL COMP	MAIL ADDR.	PROGRAM TITLE	SUPP CODE	FTSC GROUP
SC1-14	SCP	155 1734	AK	AMBLIST		13	SERVICE AID
SC1-15	SCP	155 1735	BG	AMOSADMP		02	SERVICE AID
SC1-16	SCP	155 1736	BG	AMAPTFILE		02	SERVICE AID
SC1-18	SCP	155 1738	BG	AMDPRMP EDIT		02	SERVICE AID
SC1-20	SCP	155 1830	CE	BTAM		02	BTAM
SC1-21	SCP	155 1831	AL	TCAM (LEVELS 6,8,9)		23	TCAM
		155 1832	AL	TCAM DIRECT(LEVEL 10)		23	TCAM
SC1-23	SCP	155 1833	BX	VTAM		02	VTAM
SC1-24	SCP	155 4012	CM	3600 HOST SUPPORT		02	INDUSTRY SYS
*SC1-26	SCP	155 3183	BU	CTS-RETAIL HOST		23	INDUSTRY SYS
*SC1-27	SCP	155 3192	BU	CTS-SUPERMARKET HOST		23	INDUSTRY SYS
*SC1-28	SCP	155 3182	AL	CTS-SPPS		23	INDUSTRY SYS
SC1-29	SCP	155 1839	BX	SPS/KE		02	INDUSTRY SYS
SC1-30	SCP	155 1740	CF	HMASMP		02	SMP
SC1-31	SCP	155 1841	AK	3344/3350 AP-1		13	SUPERVISOR

* INDEPENDENT RELEASE - NOT INTEGRATED WITH BASE SYSTEM.

 5799

AAA	C	099 0038		PRPQ			
AAB	A	648 0059	H	EMULATOR H120/200		01	
AAE	C	099 0038		O/L COBOL SYM DEBUG			
AAH	C	099 0038		PRPQ			
AAJ	C	099 0038		PRPQ			
AAK	C	099 0038		1800/2260 DATA ENTRY			
AAN	C	099 0038		PRPQ			
AAN	B	099 0028	T	S/S TERMINAL CTL PGM			
AAR	A	648 0229	AJ	PRPQ		02	
AAT	A	648 0239	AJ	PRPQ		02	
AAU	B	099 0028	V	PRPQ		WA	
AA-W01	A	648 0259	AK	FORTRAN H EXT PLUS		13	FORTRAN
AAY	C	099 0038		REQUIRE. PLAN. EXT.			
AAZ	C	099 0038		APPAREL BUSINESS CTL			
ABP	B	099 0029	AB	PRPQ		CH	
ACY	C	099 0038		ATS/360 3330 SUPT			
ADA	C	099 0038		S/7 FF TR-1130/1800			
ADB	C	099 0038		S/7 FF TR-05/DOS			
ADG	B	099 0028	AF	S/7 D D D-05/DOS			
ADJ	B	099 0029	AM	S/3 M6 1627 PLOTTER		RD	
ADR	C	099 0039		EMUL RCA 301/DOS			
ADT	C	099 0039		EMUL HONW 200/DOS			
ADW	B	099 0029	AM	S/3-10 1627 PLOTTER		RD	
ADZ	B	099 0028	AM	S/3-6 1627 PLOTTER		RD	
AEB	B	099 0028	AF	S/7 CAS-05/DOS		BR	
AEX	C	099 0038		S/7 RDC-05			
AEY	C	099 0038		PRPQ			
AFN	B	099 0028	AF	S/7 TMS-05/DOS		BR	
AFZ	A	648 1319	BG	3705 ASCII TRANS		23	3705 PROG
AHA	B	099 0029	AF	S/7 CAS-05/DOS		BR	
AJF	B	099 0029		APL SV			
AJR	B	099 0029	AM	S/3 M10 TQF/3		RD	
AJT	B	099 0029	AM	S/3 M15 TQF/3		RD	
AJW		348 0039	BP	S/7 TTS PRPQ		BR	
AKE	B	099 0029	AM	S/3 M10 1255/DPF		RD	
ALK	C	099 0038		APL/CMS PRPQ			
ALQ	B	099 0028		PRINTEX/370			
ALR	B	099 0028		PRINTTEXT/370			
ALX	B	099 0029	AK	GIS DOS/V5		13	
ANR	A	648 2009	AM	S/3 M15 1255 UTIL		10	

PGM NO.	SVC CLS	FESN BASE	MAIL COMP	MAIL ADDR.	PROGRAM TITLE	SUPP CODE	FTSC GROUP
AQC	B	099	0028	AK	APLSV		13
AQR	A	648	2199	F	NCP PRPQ COMPAT		63
AQT	A	648	2209	F	BSC SWIFT PRPQ		63
AQY	A	648	2239	F	NCP PRPQ COMPAT		63
ARD	B	099	0028		FIN SERV TERM		
ARE	B	099	0028		FSTS		
ARG	A	648	2089		3350/3330 MOD 11		
ARG-CA	A	648	2089	AK	DASD ERP	13	SUPERVISOR
ARG-CB	A	648	2089	AK	UNIT RECORD ERP	13	SUPERVISOR
ARG-CC	A	648	2089	O	SVC-91	13	SUPERVISOR
ARG-C2	A	648	2089	BG	SUPERVISOR	02	SUPERVISOR
ARG-C3	A	648	2089	AK	IOS	13	SUPERVISOR
ARG-C5	A	648	2089	AX	SCHEDULER	02	JOB MGMT
ARG-C9	A	648	2089	AK	SYSGEN	13	SYSGEN
ARG-D2	A	648	2089	AK	SAM/DAM/PAM	13	DATA MGMT
ARG-D3	A	648	2089	BG	DLTEP	02	DLTEP
ARG-D4	A	648	2089	AK	DADSM	13	DATA MGMT
ARG-D7	A	648	2089	BG	OBR/EREP	02	SUPERVISOR
ARG-D9	A	648	2089	BG	RMS	02	SUPERVISOR
ARG-IO	A	648	2089	AK	ISAM	13	DATA MGMT
ARG-SC	A	648	2089	AK	AP-1	13	SUPERVISOR
ARG-UH	A	648	2089	S	IEHATLAS	65	UTILITY
ARG-UK	A	648	2089	S	IEHDASDR	65	UTILITY
ARG-UN	A	648	2089	AK	SVC-98	13	UTILITY
ARG-UY	A	648	2089	S	IEBCOPY	65	UTILITY
ARG-U2	A	648	2089	S	IBCDNPRS	65	UTILITY
ARG-U3	A	648	2089	S	IBCDASDI	65	UTILITY
ARG-U5	A	648	2089	S	IEHLIST	65	UTILITY
ARQ	A	648	2159	AG	VM/370 RESOURCE MGT	02	VM 370
ATA	A	648	2149	BY	VM/370 NJI		02
ATB	B	099	0028		ASP NETWORKING		
ATC	A	648	2179		HASP NETWORKING		
WAA	A	649	0029		FILM RDR/RECORDER	02	
WAB	A	649	0079	AK	2740/2968 A/V CTL PK	13	
WAC	C	099	0038		PSHRPQ		
WAD	SCP	549	0019	AM	S/3 M10 C 1017 IOCS	10	
WAE	SCP	549	0029	AM	S/3 M10 D 1017 IOCS	10	
WAF	C	099	0039		PSHRPQ		
WA-GCO	C	099	0038		PSHRPQ		
WAH	C	099	0038		2969-1 CTL PROG		
WAM	SCP	549	0069	AM	S/3 M10 C 1018 IOCS	10	
WAN	SCP	549	0079	AM	S/3 M10 D 1018 IOCS	10	
WAU	SCP	549	0089	AP	S/3 M10 D MLTA IOCS	10	
WAZ	C	099	0038		S/7 BSC-05/DOS		
WBA	C	099	0038		S/7 BSC-1130		
WBB	C	099	0038		S/7 TPMM ASC-1130		
WBC	C	099	0038		S/7 TPMM ASC-05/DOS		
WBD	C	099	0038		S/7 7414-05/DOS		
WBE	C	099	0038		S/7 7414-1130/1800		
WBF	C	099	0038		S/7 TAPE-1130/1800		
WBG	C	099	0038		S/7 TAPE-05/DOS		
WBH	C	099	0038		S/7 1017-1130/1800		
WBJ	C	099	0038		S/7 1017-05/DOS		
WBT	C	099	0038		S/7 CX/BPE-1130/1800		
WBW	C	099	0038		S/7 CX/BPE-05/DOS		
WBZ	C	099	0038		S/7 1018-1130/1800		
WCA	C	099	0038		S/7 1018-05/DOS		
WCB	A	649	0619	AF	S/7 CH ATT-05/DOS	27	
WCE	SCP	549	0099	AP	S/3 M10 C 2501 ATT	10	
WCF	SCP	549	0109	AP	S/3 M10 D 2501 ATT	10	
WCG	C	099	0038		S/7 1627-05/DOS		
WCH	C	099	0038		S/7 1627-1130/1800		
WCT	C	099	0039		S/7 SBGA-05/DOS		
WCH	C	099	0038		S/7 MAG RDR-05/DOS		
WCY	B	099	0028	AF	S/7 TAPE CASSETTE	BR	

PAGE OF : G229-2228-20
 REVISED : OCTOBER 1977
 BY TNL : GN25-0005-3

PGM NO.	SVC CLS	FESN BASE	MAIL COMP	MAIL ADDR.	PROGRAM TITLE	SUPP CODE	FTSC GROUP
WCZ	C	099	0038		5930 BTAM DOS		
WDA	C	099	0038		5930 BTAM OS		
WDB	C	099	0038		S/7 CD REC-1130/1800		
WDC	C	099	0038		S/7 CD REC-OS/DOS		
WDD	C	099	0038		S/7 7431-1130/1800		
WDE	C	099	0038		S/7 7431-OS/DOS		
WDF	SCP	549	0119	AM	S/3 MOD6 1017 IOCS	10	
WDG	C	099	0038		S/7 029 CD RDR ATT		
WDK	C	099	0038		S/7 SBCU-OS		
WDL	SCP	549	0129	AM	S/3 MOD6 1018 IOCS	10	
WDM	C	099	0038		S/7 TPMM ASC-1800		
WDN	C	099	0038		S/7 BSC-1800		
WDP	SCP	549	0179	AM	S/3 M10 1017/1442	10	
WDT	SCP	549	0169	AM	S/3 M10 2793/2797	10	
WEA	B	099	0028	AF	S/7 AUD RESP-OS/DOS	BR	
WEC	B	099	0028	AF	S/7 I T S-OS/DOS	BR	
WEH	C	099	0038		S/7 3410 ATTACHMENT		
WER	B	099	0029	AM	S/3 M10 3735 SUPPORT	RO	
WEZ	C	099	0038		00S SUPPORT 3735		
WFD	SCP	549	0209	AM	S/3 M10 1018/1442	10	
WFE	B	099	0028	AF	S/7 EXT ITS-OS/DOS	BR	
WFF	C	099	0038		S/7 TPMM BSC-1130		
WFG	A	649	1649	AF	S/7 TPMM BSC-OS/DOS	27	
WFH	C	099	0038		S/7 TPMM BSC-1800		
WFJ	SCP	549	0219	AM	S/3 DUMP/RESTORE	10	
WFK	SCP	549	0229	AP	S/3 M15 A/B/C MLTA	10	
WGF	A	649	1709	CC	5930 BTAM 2701/2/3	63	
WGG	A	649	1719	CC	5930 BTAM 2701/2/3	63	
WGH	A	649	1729	CC	5930 BTAM 2701/2/3	63	
WGJ	A	649	1739	CC	5930 BTAM 3704/5	63	
WGK	A	649	1749	CC	5930 BTAM 3704/5	63	
WGL	A	649	1759	CC	5930 BTAM 3704/5	63	
WGX	SCP	549	0339	AP	S/3 M10 D 2956 ATT	10	
WGY	SCP	549	0349	AP	S/3 M10 INT. TIMER	10	
WHG	SCP	549	0379	AP	S/3 M10 BSCA MODIF	10	
WHL	SCP	549	0399	AP	S/3 M10 2ND 1403 ATT	10	
WHP	SCP	549	0409	AM	S/3 M15 1017 IOCS	10	
WHQ	B	099	0029	AM	S/3 M15 3735 SUPPORT	RO	
WHT	SCP	549	0419	AM	S/3 M15 1018 IOCS	10	
WHX	B	099	0028		DOS/VS RJE WK STAT		
WHZ	B	099	0028		3333/3330 DISK STORAGE		
WJH	SCP	549	0469	AF	S/7 3340 ATT OS/VS	27	
WJJ	SCP	549	0479	AF	S/7 3340 ATT DOS/VS	27	
WJK	SCP	549	0489	AF	S/7 3340 ATT	27	
WJX	A	649	2019	AF	S/7 3340 ATT DOS	27	
WJY	A	649	2029	AF	S/7 3340 ATT OS	27	
WJW	A	649	2079	CJ	3890 PRPQ SUPPORT	02	DATA MGMT
WKH	SCP	549	0579	AP	S/3 M12 MLTA IOCS	10	
WLD	SCP	549	2089	AP	S/3 M15 D MLTA IOCS	10	
7040, 7080, 7090							
-ALL-	C	099	0039		-ALL 7040, 7080, 7090 PROGRAMS-		

031 7770 FIELD DEVELOPED PGMS

OLT APAR MAILING LIST

THIS LIST PROVIDES THE COMPONENT IDENTIFICATION NUMBERS USED IN CONJUNCTION WITH THE AUTHORIZED PROGRAM ANALYSIS REPORT (APAR), LOCATION "N" ON THE FORM. THE ID NUMBERS REFERENCE THE MAJOR OLT "FAMILY" AND ARE LISTED NUMERICALLY. ENTER RUN NAME AND VERSION LEVEL IN LOCATION "S". THE FIRST WORD OF THE ABSTRACT SHOULD CORRESPOND TO THE SYMPTOM CODE, ALSO INCLUDE THE OP SYSTEM RELEASE LEVEL IF NOT OPERATING UNDER OLTSEP. AN ADDRESS CODE IS LISTED BESIDE EACH COMPONENT IDENTIFICATION NUMBER WHICH REFERENCES THE APAR MAILING ADDRESS.

<u>COMPONENT</u>	<u>MAIL_ADDR.</u>	<u>COMPONENT</u>	<u>MAIL_ADDR.</u>
OLTS0200A	BD	OLTS2820A	BD
OLTS0370A	BJ	OLTS2821A	AN
OLTS1012A	BD	OLTS2826A	BE
OLTS1030A	X	OLTS2835A	BD
OLTS1050A	X	OLTS2841A	BD
OLTS1060A	X	OLTS2845A	X
OLTS1231A	AQ	OLTS2848A	X
OLTS1255A	AN	OLTS2947A	BK
OLTS1270A	BE	OLTS2955A	AH
OLTS1275A	BE	OLTS2970A	AD
OLTS1285A	AQ	OLTS2972A	AD
OLTS1287A	AQ	OLTS2976A	X
OLTS1288A	AQ	OLTS3155A	BH
OLTS1403A	AN	OLTS3158A	BH
OLTS1404A	AN	OLTS3165A	BJ
OLTS1419A	AN	OLTS3168A	BJ
OLTS1442A	AQ	OLTS3210A	AN
OLTS1443A	AN	OLTS3215A	AN
OLTS1445A	AN	OLTS3270A	AD
OLTS2150A	BJ	OLTS3271A	AD
OLTS2245A	BB	OLTS3330A	BD
OLTS2250A	AD	OLTS3340A	BD
OLTS2260A	X	OLTS3410A	CD
OLTS2265A	X	OLTS3420A	CD
OLTS2301A	BD	OLTS3505A	AQ
OLTS2303A	BD	OLTS3525A	AQ
OLTS2305A	BD	OLTS3540A	AQ
OLTS2311A	BD	OLTS3670A	X
OLTS2313A	BD	OLTS3700A	X
OLTS2314A	BD	OLTS3704A	X
OLTS2321A	BD	OLTS3705A	X
OLTS2400A	CD	OLTS3735A	X
OLTS2495A	BG	OLTS3811A	AN
OLTS5201A	AQ	OLTS3830A	BD
OLTS2520A	AQ	OLTS3850A	O
OLTS2540A	AN	OLTS3881A	AQ
OLTS2596A	AQ	OLTS3886A	AQ
OLTS2671A	BC	OLTS3890A	AN
OLTS2700A	X	OLTS3945A	BB
OLTS2701A	X	OLTS4640A	AN
OLTS2702A	X	OLTS5010A	BV
OLTS2703A	X	OLTS5098A	BV
		OLTS5998A	BV
OLTS2715A	X	OLTS7770A	X
OLTS2740A	X	OLTSSEPCO	BG
OLTS2741A	X	OLTSSEPDPT	BG
OLTS2760A	X	OLTS50SPB	BG
		OLTSWINCO	BG

PAGE OF : G229-2228-20
REVISED : OCTOBER 1977
BY TNL : GN25-0005-3

APAR MAILING ADDRESSES

- D- DELETED JANUARY 1976
 - E- *SEE INSTRUCTIONS FOR SUBMITTAL OF APARS
TO EUROPEAN LOCATIONS.
 - F- *SEE INSTRUCTIONS FOR SUBMITTAL OF APARS
TO EUROPEAN LOCATIONS.
 - G- *SEE INSTRUCTIONS FOR SUBMITTAL OF APARS
TO EUROPEAN LOCATIONS.
 - H- *SEE INSTRUCTIONS FOR SUBMITTAL OF APARS
TO EUROPEAN LOCATIONS.
 - J- DELETED MARCH 1976
 - K- DELETED MARCH 1976
 - N- IBM CORPORATION
APAR PROCESSING
DEPT. 772
1133 WESTCHESTER AVE.
WHITE PLAINS, N. Y. 10604
-NO PREPAID MAILING LABEL-
 - O- IBM CORPORATION
APAR PROCESSING
P.O. BOX 1900
BOULDER, COLORADO 80302
-NO PREPAID MAILING LABEL-
 - R- IBM CORPORATION
APAR PROCESSING
LOS ANGELES DEVELOPMENT CENTER
1930 CENTURY PARK WEST
LOS ANGELES, CALIFORNIA 90067
-NO PREPAID MAILING LABEL-
 - S- *SEE INSTRUCTIONS FOR SUBMITTAL OF APARS
TO EUROPEAN LOCATIONS.
 - T- IBM CORPORATION
2651 STRANG BLVD.
DEPT. 935
YORKTOWN HEIGHTS, N. Y. 10598
ATTN: MR. ELLIS JONES
-NO PREPAID MAILING LABEL-
 - U- IBM CORPORATION
APAR PROCESSING
DEPT. 835
112 EAST POST ROAD
WHITE PLAINS, N. Y. 10601
-NO PREPAID MAILING LABEL-
- * - WORLD TRADE LOCATIONS SHOULD NOT MAIL APARS
TO THESE ADDRESSES. REFER TO WORLD TRADE
GENERAL PSM NO. 1 FOR PROPER APAR MAILING
ADDRESSES IF YOU ARE SUBMITTING AN APAR FROM
A WORLD TRADE LOCATION.

V- IBM CORPORATION
APAR PROCESSING
WASHINGTON DEVELOPMENT CENTER
11141 GEORGIA AVE.
WHEATON, MARYLAND 20902
-NO PREPAID MAILING LABEL-
W- DELETED SEPTEMBER 1976
X- IBM CORPORATION
APAR PROCESSING
DEPT. G62, BLDG. 061
RESEARCH TRIANGLE PARK, N. C. 27709
-NO PREPAID MAILING LABEL-
Y- DELETED MARCH 1976
AA- DELETED MARCH 1977 (SEE AK)
AB- IBM CORPORATION
APAR PROCESSING
TECHNICAL SERVICES MANAGER
380 NORTHWEST HIGHWAY
DES PLAINES, ILLINOIS 60016
-NO PREPAID MAILING LABEL-
AC- IBM CORPORATION
APAR PROCESSING
DEPT. 888 - 3RD FLOOR
1350 AVENUE OF THE AMERICAS
NEW YORK, N. Y. 10019
-NO PREPAID MAILING LABEL-
AD- IBM CORPORATION
DEPT. 57Q, BLDG. 202
NEIGHBORHOOD ROAD
KINGSTON, N. Y. 12401
-NO PREPAID MAILING LABEL-
AE- IBM CORPORATION
SERIES/1 APAR CONTROL
P.O. BOX 1328
BOCA RATON, FLORIDA 33432
-NO PREPAID MAILING LABEL-
AF- IBM CORPORATION
APAR PROCESSING
DEPT. 23B, BLDG. 203
P.O. BOX 1328
BOCA RATON, FLORIDA 33432
-NO PREPAID MAILING LABEL-
AG- IBM CORPORATION
APAR PROCESSING
I DEPT. H68, BLDG. 706-2
P.O. BOX 390
POUGHKEEPSIE, N. Y. 12602
-NO PREPAID MAILING LABEL-

PAGE OF : G229-2228-20
REVISED : OCTOBER 1977
BY TNL : GN25-0005-3

AH- IBM CORPORATION
MAINTENANCE TECHNOLOGY APAR COORDINATOR
P.O. BOX 12195
DEPT. 817-X585, BLDG. 051
RESEARCH TRIANGLE PARK, N. C. 27709
-NO PREPAID MAILING LABEL-

AJ- IBM CORPORATION
GEM REGION DESIGN CENTER
APAR PROCESSING
10401 FERNWOOD ROAD
BETHESDA, MD. 20034
-NO PREPAID MAILING LABEL-

AK- IBM CORPORATION
APAR PROCESSING
SANTA TERESA LAB
555 BAILEY AVE.
P. O. BOX 50020
SAN JOSE, CALIFORNIA 95150
-PREPAID MAILING LABEL FORM NO. S229-2159-

AL- IBM CORPORATION
APAR PROCESSING
BOX 12134
RESEARCH TRIANGLE PARK, N. C. 27709
-PREPAID MAILING LABEL FORM NO. S229-2160-

AM- IBM CORPORATION
APAR PROCESSING
DEPT. 430
3605 HIGHWAY 52 N.
ROCHESTER, MINN. 55901
-NO PREPAID MAILING LABEL-

AN- IBM CORPORATION
APAR PROCESSING
DEPT. 74C, MODULE 20
P.O. BOX 6
ENDICOTT, N. Y. 13760
-PREPAID MAILING LABEL FORM NO. S229-2236-

AO- IBM CORPORATION
APAR PROCESSING
CUSTOM SYSTEMS PROGRAMMING
P.O. BOX 390
DEPT. C47, BLDG. 702
POUGHKEEPSIE, N. Y. 12602
-NO PREPAID MAILING LABEL-

AP- IBM CORPORATION
SYSTEM/3 APAR CONTROL
DEPT. 252
37TH ST., HIGHWAY 52 N.W.
ROCHESTER, MINN. 55901
-NO PREPAID MAILING LABEL-

AQ- IBM CORPORATION
DEPT. 400
HIGHWAY 52 AND NW 37TH STREET
ROCHESTER, MINN. 55901
-NO PREPAID MAILING LABEL-

AR- DELETED MARCH 1977

IAS- DELETED OCTOBER 1977
AT- DELETED APRIL 1977
AV- DELETED MARCH 1976
AW- IBM CORPORATION
DEPT. LSI
3540 APAR PROC.
18100 FREDERICK PIKE
GAITHERSBURG, MD. 20760
-NO PREPAID MAILING LABEL-
AX- IBM CORPORATION
APAR PROCESSING
P. O. BOX 12134
DEPT. 944, X585
RESEARCH TRIANGLE PARK, N. C. 27709
-NO PREPAID MAILING LABEL-
AY- IBM CANADA, LTD.
1445 WEST GEORGIA STREET
VANCOUVER 5, BRITISH COLUMBIA
CANADA
-NO PREPAID MAILING LABEL-
AZ- IBM CORPORATION
APAR PROCESSING
DEPT. D54, BLDG. 705
P.O. BOX 390
POUGHKEEPSIE, N. Y. 12602
-NO PREPAID MAILING LABEL-
BA- IBM U. K. LABORATORIES, LTD.
MAILPOINT 168
HURSLEY PARK, WINCHESTER
HANTS, ENGLAND
-NO PREPAID MAILING LABEL-
BB- IBM JAPAN
DEPT. 811, RAS
1 KIRIHARA-CHO, FUJISAWA-SHI
KANAGAWA-KEN
JAPAN 252
-NO PREPAID MAILING LABEL-
BC- IBM CORPORATION
CER - DEPT. 0766
06610 LAGAUE, FRANCE
-NO PREPAID MAILING LABEL-
BD- IBM CORPORATION
APAR PROCESSING
DEPT. D06, BLDG. 026
5600 COTTLE ROAD
SAN JOSE, CALIFORNIA 95193
-NO PREPAID MAILING LABEL-
BE- IBM CORPORATION
A. DE BOER
RAS DEPARTMENT
P.O. BOX 24
UITHOORN, NETHERLANDS
-NO PREPAID MAILING LABEL-
BF- DELETED JUNE 1977

* - WORLD TRADE LOCATIONS SHOULD NOT MAIL APARS
TO THESE ADDRESSES. REFER TO WORLD TRADE
GENERAL PSM NO. 1 FOR PROPER APAR MAILING
ADDRESSES IF YOU ARE SUBMITTING AN APAR FROM
A WORLD TRADE LOCATION.

PAGE OF : G229-2228-20
REVISED : OCTOBER 1977
BY TNL : GN25-0005-3

BG- IBM CORPORATION
APAR PROCESSING (ENTER PROGRAM NUMBER ON LABEL)
DEPT. 77Q LOCATION I6-2-3C-63
18100 FREDERICK PIKE
GAITHERSBURG, MD. 20760
NOTE: SHIP BY FEDERAL EXPRESS
-NO PREPAID MAILING LABEL-
BH- IBM CORPORATION
APAR COORDINATOR
DEPT. D61, BLDG. 705
P.O. BOX 390
POUGHKEEPSIE, N. Y. 12602
-NO PREPAID MAILING LABEL-
BJ- IBM CORPORATION
APAR COORDINATOR
DEPT. 874, BLDG. 707
P.O. BOX 390
POUGHKEEPSIE, N. Y. 12602
-NO PREPAID MAILING LABEL-
BK- IBM CORPORATION
APAR COORDINATOR
DEPT. C47, BLDG. 702
P.O. BOX 390
POUGHKEEPSIE, N. Y. 12602
-NO PREPAID MAILING LABEL-
BL- IBM CORPORATION
APAR PROCESSING
DEPT. 70R
1133 WESTCHESTER AVE.
WHITE PLAINS, N. Y. 10604
-NO PREPAID MAILING LABEL-
BM- IBM CORPORATION
APAR PROCESSING
I DEPT. D82, BLDG. 706
P.O. BOX 390
POUGHKEEPSIE, N. Y. 12602
-NO PREPAID MAILING LABEL-
BN- IBM CORPORATION
APAR PROCESSING
P.O. BOX 390
DEPT. D11, BLDG. 706
POUGHKEEPSIE, N. Y. 12602
-NO PREPAID MAILING LABEL-
BO- IBM CORPORATION
APAR PROCESSING
2800 SAND HILL ROAD
MENLO PARK, CALIFORNIA 94025
-NO PREPAID MAILING LABEL-
BP- IBM CORPORATION
APAR PROCESSING
DEPT. 212031 1
P.O. BOX 1328
BOCA RATON, FLORIDA 33432
-NO PREPAID MAILING LABEL-
BQ- DELETED MARCH 1977 (SEE AK)
BR- IBM CORPORATION
APAR PROCESSING
P.O. BOX 390
DEPT. D94, BLDG. 706
POUGHKEEPSIE, N. Y. 12602
-NO PREPAID MAILING LABEL-

- BS- IBM CORPORATION
APAR PROCESSING
P.O. BOX 390
DEPT. B52, BLDG. 707
POUGHKEEPSIE, N. Y. 126C2
-NO PREPAID MAILING LABEL
- BT- IBM CORPORATION
APAR PROCESSING
DEPT. 63M, BLDG. 201-2
NEIGHBORHOOD ROAD
KINGSTON, N. Y. 12401
-NO PREPAID MAILING LABEL-
- BU- IBM CORPORATION
P.O. BOX 12134
RESEARCH TRIANGLE PARK, N. C. 27709
ATTN: APAR COORDINATOR DEPT. F32/D537
BLDG. 602
-NO PREPAID MAILING LABEL
- BV- IBM CORPORATION
APAR PROCESSING
DEPT. 26N, BLDG. 203
P.O. BOX 1328
BOCA RATON, FLORIDA 33432
-NO PREPAID MAILING LABEL-
- BW- IBM CORPORATION
1439 PEACHTREE STREET N.E.
ATLANTA, GEORGIA 30309
ATTN: W. W. LYONS
-NO PREPAID MAILING LABEL-
- BX- IBM CORPORATION
APAR PROCESSING
DEPT. 74M, BLDG. 001
NEIGHBORHOOD ROAD
KINGSTON, N. Y. 12401
-NO PREPAID MAILING LABEL-
- BY- IBM CAMBRIDGE SCIENTIFIC CENTER
545 TECHNICAL SQUARE
CAMBRIDGE, MASS. 02139
-NO PREPAID MAILING LABEL-
- CB- *SEE INSTRUCTIONS FOR SUBMITTAL OF APARS
TO EUROPEAN LOCATIONS.
- CC- IBM CORPORATION
SYSTEM/32 APAR CONTROL
DEPT. 540
37TH STREET AND HIGHWAY 52 NW
ROCHESTER, MINN. 55901
-NO PREPAID MAILING LABEL-
- CD- IBM CORPORATION
APAR PROCESSING
DEPT. G77, BLDG. 142
5600 COTTLE ROAD
SAN JOSE, CALIFORNIA 95114
-NO PREPAID MAILING LABEL-
- CE- IBM CORPORATION
APAR PROCESSING
P. O. BOX 12134
DEPT. 943, X585
RESEARCH TRIANGLE PARK, N. C. 27709
-NO PREPAID MAILING LABEL-

* - WORLD TRADE LOCATIONS SHOULD NOT MAIL APARS TO THESE ADDRESSES. REFER TO WORLD TRADE GENERAL PSM NO. 1 FOR PROPER APAR MAILING ADDRESSES IF YOU ARE SUBMITTING AN APAR FROM A WORLD TRADE LOCATION.

PAGE OF : G229-2228-20
REVISED : OCTOBER 1977
BY TNL : GN25-0005-3

CF- IBM CORPORATION
APAR PROCESSING
P. O. BOX 12134
DEPT. 942, X585
RESEARCH TRIANGLE PARK, N. C. 27709
-NO PREPAID MAILING LABEL-

CG- IBM CORPORATION
APAR PROCESSING
P.O. BOX 390
DEPT. D95, BLDG. 705
POUGHKEEPSIE, N. Y. 12602
-NO PREPAID MAILING LABEL-

CH- DELETED FEBRUARY 1976

CI- IBM CORPORATION
EXTM APAR PROCESSING
P. O. BOX 12195
DEPT. 997, H589
RESEARCH TRIANGLE PARK, N. C. 27709
-NO PREPAID MAILING LABEL-

CJ- IBM CORPORATION
FINANCE INDUSTRY DEVELOPMENT
DEPT. 849
1133 WESTCHESTER AVE., 1-CP
WHITE PLAINS, N. Y. 10604
-NO PREPAID MAILING LABEL-

CK- IBM CORPORATION
APAR PROCESSING COORDINATOR
TCS-PROGRAM DEVELOPMENT
DEPT. 82L
1133 WESTCHESTER AVENUE
WHITE PLAINS, N. Y. 10604
-NO PREPAID MAILING LABEL-

CL- IBM CORPORATION
APAR PROCESSING
DEPT. D91, BLDG. 707
P. O. BOX 390
POUGHKEEPSIE, N. Y. 12602
-NO PREPAID MAILING LABEL-

CM- IBM CORPORATION
APAR PROCESSING
DEPT. 568, BLDG. 003
NEIGHBORHOOD ROAD
KINGSTON, N. Y. 12401
-NO PREPAID MAILING LABEL-

CN- IBM CORPORATION
APAR PROCESSING
TCAM IMS INTERFACE
DEPT. 69M/037-PAS4
1501 CALIFORNIA AVE.
PALO ALTO, CALIFORNIA 94304
-NO PREPAID MAILING LABEL-

CX- DELETED JANUARY 1977

DA- IBM CORPORATION
APAR PROCESSING
DEPT. D93N, BLDG. 203
P. O. BOX 1328
BOCA RATON, FLORIDA 33432
-NO PREPAID MAILING LABEL-

DB- IBM CORPORATION
APAR PROCESSING
DEPT. D26W
2800 SAND HILL ROAD
MENLO PARK, CAL. 94025
-NO PREPAID MAILING LABEL-

EESER MAILING ADDRESSES

SUPPORT CODE

01, 02, 03 62, 63 64, 66	IBM CORPORATION PROGRAMMING SYSTEM MGR. BLDG. 947 DEPT. H74 IBM ROAD POUGHKEEPSIE, N. Y. 12602
10	IBM CORPORATION SERVICE PLANNING MANAGER BLDG. 109, DEPT. 900 37TH ST., HIGHWAY 52 N.W. ROCHESTER, MN. 55901
13, 65	IBM CORPORATION PROGRAMMING SYSTEMS MGR. DEPT. T20 555 BAILEY AVE. SAN JOSE, CA. 95150
23	IBM CORPORATION SERVICE PLANNING MANAGER DEPT. 952/A073 BLDG. 060 RESEARCH TRIANGLE PARK RALEIGH, N. C. 27709
27	IBM CORPORATION P.O. BOX 1328 BLDG. 001-3, DEPT. 90D BOCA RATON, FLA. 33432

PAGE OF : G229-2228-20
 REVISED : OCTOBER 1977
 BY TNL : GN25-0005-3

IN ADDITION TO PLM NUMBERS, THIS SECTION NOW INCLUDES THE MICRO-FICHE NUMBERS. THE FTSC GROUP HAS BEEN MOVED TO THE PROGRAM ID PAGES.

PROGRAM TITLE	PROGRAM	PLM NUMBER(S)	MICROFICHE NO.
360A-APPLICATION			
ASP SYS OS VER 2	CX-15X	GY20-0305	GYB0-0508
ASP SYS OS VER 3	CX-15X	GY20-0305	GYB0-0854
DOS MACLIB/RELOCATE	TX-016	GY34-0010	GYD1-1790
			GYD1-1794
OS MACLIB/RELOCATE	TX-026	GY34-0010	GJD1-1790
			GJD1-1794
360Q-APPLICATION			
HASP	51014		GYB0-0512
360H-3705			
3705 EP SUPPORT	TX-033	SY30-3001	GJD2-4102
3705 NCP FOR OS	TX-034	SY30-3003	GJD2-4105
3705 SSP FOR OS	TX-035	SY30-3001	GJD2-4101
360N-DOS			
DOS/360 FORTRAN IV	FO-479	GY28-6394	GJD1-2056
			GYC7-1922
DOS/360 FORT4 LIB	LM-480		GJD1-2056
			GYC7-1923
360P-RPS			
OS/360 DASDI	UT-213		
OS/360 DUMP RESTORE	UT-214		
OS/360 RECOVERY	UT-215		
360S-OS			
ACCESS METHODS	O2-508		
BTAM-2740 MCS	CQ-513		
CATALOG	D3-508	GY28-6606	
DADSM	D4-508	GY28-6607	
DM CHKPT RESTART	D7-508		
HMASMP	DN-611	GC28-6791	GJD1-1100
IEHMAN	UT-558		
IMASPZAP	D3-554		
IMBLIST	D8-554		
IMBMDMAP	D7-554		
IMCJODMP	D5-554		
INDPRDMP	D2-554		
IMDSADMP	D1-554		
IOS MFT	C3-505		GJD1-1010
IOS MVT	C3-535		
IOS TSO	C3-555		
LINK LOADGO PROMPTER	CL-555		
MFT CHKPOINT RESTART	CG-505		GJD1-1010
MFT DISK ERP	CA-505		GJD1-1010
MFT GRAPH OPR SUPP	C4-505		GJD1-1010
MFT GTF	CP-505		GJD1-1010
MFT LKED OVLY SUPVR	C6-505		GJD1-1010
MFT SHED	C5-505		GJD1-1010
MFT SYSGEN	C9-505		GJD1-1010
MFT SYSOUT	C7-505		GJD1-1010
MFT TP ERP	CC-505		GJD1-1010
MFT UNIT REC ERP	CB-505		GJD1-1010

PAGE OF : G229-2228-20
 REVISED : OCTOBER 1977
 BY TNL : GN25-0005-3

<u>PROGRAM TITLE</u>	<u>PROGRAM</u>	<u>PLM NUMBER(S)</u>	<u>MICROFICHE NO.</u>
MFT 12XX ERP	CE-505		GJD1-1010
MFT 1419-1275 ERP	CD-505		GJD1-1010
MFT 2495 ERP	CF-505		GJD1-1010
MVT CHKPOINT RESTART	CG-535		
MVT DISK ERP	CA-535		
MVT GRAPH OPR SUPP	C4-535		
MVT GTF	CP-535		
MVT LKED OVLY SUPVR	C6-535		
MVT SCHED	C5-535		
MVT SYSGEN	C9-535		
MVT SYSOUT	C7-535		
MVT TP ERP	CC-535		
MVT UNIT REC ERP	CB-535		
MVT 12XX ERP	CE-535		
MVT 1419-1275 ERP	CD-535		
MVT 2495 ERP	CF-535		
OLTEP	DN-533		
OPEN/CLOSE/EOV	D1-503	GY28 6609	
OPT/RDR 12XX	D5-508		
OS/360 UTILITIES	C1-555	GY27-7199	
POWER WARNING FEATURE	DN-614		
RDR 1419/1275	D6-508		
RECOVERY MGMT M65	DN-539	GY27-7155	
SERO/1/OBR/EREPO	DN-527		
SMF SAMPLIB	CN-505		GJD1-1010
SMF SAMPLIB	CN-535		
STARTER SYS/2314	C1-534		
STARTER SYSTEM	C1-514		
SUPERVISOR MFT	C2-505	GY27-7244	GJD1-1010
SUPERVISOR MVT	C2-535		
SUPERVISOR TSO	C2-555		
TCAM	C1-548		
TOTE	C3-548		
TSO CHKPT RESTART	CG-555		
TSO DATA MGMT	CK-555		
TSO DISK ERP	CA-555		
TSO GRAPH OPR SUPP	C4-555		
TSO GTF	CP-555		
TSO LKED OVLY SUPVR	C6-555		
TSO SCHED	C5-555		
TSO SYSGEN	C9-555		
TSO SYSOUT	C7-555		
TSO TCAM	C2-548		
TSO TP ERP	CC-555		
TSO UNIT REC ERP	CB-555		
TSO 12XX ERP	CE-555		
TSO 1419/1275 ERP	CD-555		
TSO 2495 ERP	CF-555		
155 ERROR RECOVERY	D1-527		
2245-3211 SUPPORT	D8-508		
3505-3525 SUPPORT	D9-508		
<u>37QH</u>			
HASP II VERSION 4	TX-001		GY80-0856

PAGE OF : G229-2228-20
 REVISED : OCTOBER 1977
 BY TNL : GN25-0005-3

<u>PROGRAM TITLE</u>	<u>PROGRAM</u>	<u>PLM NUMBER(S)</u>	<u>MICROFICHE NO.</u>
<u>5701-SYS/3-MOD 10 (CARD SYSTEM)</u>			
S/3 CARD SYSTEM	SC1	SY21-0521	
<u>5702-SYS/3-MOD 10 (DISK SYSTEM)</u>			
S/3 ANS COBOL	CB1	LY28-6421	LYC7-1347
S/3 BASIC ASSEM	AS1	LY21-0504	LYC7-1303
S/3 CARD UTILITIES	UT1	LY21-0523	LYC7-1302
S/3 DISK SYSTEM	SC1	SY21-0502	SYC7-1100
		SY21-0503	SYC7-1121
		SY21-0512	SYC7-1123
		SY21-0526	
		SY21-0527	
		SY21-0531	
		SY21-0543	
		SY21-0544	
S/3 DISK RPG II	RG1	LY21-0501	LYC7-1300
			LYC7-1342
S/3 DISK SORT	SM1	LY21-0517	LYC7-1301
S/3 FORTRAN IV	FO1	LY28-6848	LYC7-5046
S/3 1255-UTILITY	UT2	LY21-0016	LYC7-1304
<u>5703-SYS/3-MOD 4 6 6</u>			
S/3 CCP/DISK SORT	SM2		LYC7-1341
S/3 CONV UTIL	UT1	LY21-0524	LYC7-1310
S/3 DISK RPG II	RG1	LY21-0501	LYC7-1307
			LYC7-1343
S/3 DISK SORT	SM1	LY21-0517	LYC7-1309
S/3 DISK SYSTEM	SC1	SY21-0502	SYC7-1103
		SY21-0503	SYC7-1124
		SY21-0512	SYC7-1138
		SY21-0526	
		SY21-0531	
		SY21-0544	
S/3 FORTRAN IV	FO1	LY28-6848	LYC7-5046
<u>5704-SYS/3 MOD 15</u>			
S/3 ANS COBOL	CB1,CB2	LY28-6421	LYC7-1323
			LYC7-1347
S/3 BASIC ASSEMBLER	AS1,AS2	LY21-0504	LYC7-1322
			LYC7-1346
S/3 DISK SYSTEM	SC1	SY21-0032	SYC7-1125
	SC1,SC2	SY21-0033	SYC7-1126
	SC1,SC2	SY21-0034	SYC7-1132
	SC1,SC2	SY21-0035	
	SC1,SC2	SY21-0036	
	SC1,SC2	SY21-0040	
	SC2	SY21-0052	SYC7-1140
	SC1,SC2	SY21-0526	SYC7-1141
	SC1,SC2	SY21-0543	SYC7-1142
	SC1,SC2	SY21-0552	

<u>PROGRAM TITLE</u>	<u>PROGRAM</u>	<u>PLM NUMBER(S)</u>	<u>MICROFICHE NO.</u>
S/3 FORTRAN	FO1,FO2	LY28-6848	LYC7-1328 LYC7-1348
S/3 RPG	RG1,RG2	LY21-0501	LYC7-1324 LYC7-1344 LYC7-1349
S/3 DISK SORT	SM1,SM9	LY21-0517	LYC7-1325 LYC7-1350
S/3 TAPE SORT	SM7 SM2,SM8	LY21-0517 LY21-0529	LYC7-1351 LYC7-1326 LYC7-1352
S/3 CARD UTILITIES	UT1,UT3	LY21-0031	LYC7-1327 LYC7-1353
<u>5705-SYS/3 MOD 12</u>			
BASIC ASSEMBLER	AS1	LY21-0504	LYC7-1333
COBOL	CB1	LY28-6421	LYC7-1334
DISK SCP	SC1	SY21-0045 SY21-0046 SY21-0526 SY21-0527 SY21-0531 SY21-0544	SYC7-1134 SYC7-1135 SYC7-1136
DISK SORT	SM1	LY21-0517	LYC7-1337
FORTTRAN IV	FO1	LY28-6848	LYC7-1335
RPG	RG1	LY21-0501	LYC7-1336 LYC7-1345
TAPE SORT	SM2	LY21-0529	LYC7-1338
UTILITIES	UT1	LY21-0031	LYC7-1339
1255 UTILITIES	UT2	LY21-0016	LYC7-1334
<u>5707-SYS/7</u>			
MSP/7 ASM/7	AD1		SJD1-1791
MSP/7 DSS/7	SC2	GY34-0011	
MSP/7 DSS/7 8-12K	AG1		SJD1-1792
MSP/7 FORT IV	FO1		
MSP/7 LINK/7	AF1		SJD1-1791
MSP/7 PROCLIB	AB1		
MSP/7 SLE	AE1		SJD1-1791
MSP/7 SYSCODE	AC1	GY34-0012	GJD1-1790 GJD1-1794
SYS/7 PPF	AA1		SJD1-1791
<u>5718-SYS/7</u>			
S/7 SCP	SC2		

PAGE OF : G229-2228-20
 REVISED : OCTOBER 1977
 BY TNL : GN25-0005-3

<u>PROGRAM TITLE</u>	<u>PROGRAM</u>	<u>PLM NUMBER(S)</u>	<u>MICROFICHE NO.</u>
<u>5719-SERIES/1</u>			
FC/PM2,3,APPU	U12	LH30-0178 LH30-0179	
FORTRAN IV COMP & OBJ	FO1	LY34-0134	LJD1-1817
FORTRAN IV REALTIME	FO3	LY34-0135	LJD1-1818
MFSL	LM1	LY34-0139	LJD1-1821
PL/1 COMP & RES	PL1		LJD1-1819
PL/1 TRANSIENT	PL3		LJD1-1820
PROG PREP SUB	PL1,PL3	LY34-0086	
	AS1		
	AS-1AB	LY34-0125	LJD1-1830
	AS-1IN	LY34-0122	LJD1-1827
	AS-1JS	LY34-0122	LJD1-1827
	AS-1MA	LY34-0124	LJD1-1829
	AS-1TE	LY34-0123	LJD1-1828
REALTIME PROG SYS	PC1		
	PC-1CM	LY34-0105	LJD1-1824
	PC-1DM	LY34-0104	LJD1-1823
	PC-1SG	LY34-0107	LJD1-1825
	PC-1SS	LY34-0103	LJD1-1822
	PC-1UT	LY34-0107	LJD1-1825
REAL PROG SYS MACROS			LJD1-1826
STANDALONE UTIL	SC2	GY34-0071	GJD1-1813
<u>5725-SYSTEM/32</u>			
CONTROL STORE U CODE	SC-1CS	SY21-0533	SYC7-1139
DATA MANAGEMENT	SC-1DM	SY21-0535	SYC7-1139
RPGII	RG1	LY21-0538	LYC7-1331
SCHEDULAR	SC-1SH	SY21-0534	SYC7-1139
SYS. DATA AREAS HANDBOOK		SY21-0532	
SYS. SERVICES	SC1	SY21-0536 SY21-0537 SY21-0551 SY21-0567	SYC7-1139
UTILITIES	UT1	LY21-0539	LYC7-1332
WORD PROCESSOR	XX-1		LYC7-1354

<u>PROGRAM TITLE</u>	<u>PROGRAM</u>	<u>PLM NUMBER(S)</u>	<u>MICROFICHE NO.</u>
<u>5734-OS/V51/V52_PP</u>			
CICS/OS-STANDARD V2	XX7		LY80-0781
COBOL V3	CB1	LY28-6407	LYC7-5038
COBOL V4	CB-202	LY28-6420	LYC7-5045
COBOL V4 LIB ONLY	LM-201	LY28-6419	LYC7-5045
FORTRAN IV G1 COMP	FO-201		LYC7-5021
FORTRAN IV H EXT CMP	FO-301		LYC7-5019
FORTRAN IV LIB MOD 2	LM-301	LY28-6409	LYC7-5020
GIS/2-2	XX1	LY20-0697	
		LY20-0809	
IMS/360 V2 DATA BASE	XX-634	LY20-0630	LY80-0631
IQF/IMS	XX-635	LY20-0630	LY80-0834
		LY20-0829	
OS FORT/7	FO4		
OS PL/1 CHECKOUT CMP	PL-241	LY33-6013	LYC7-2500
		LY33-6014	
OS PL/1 OPT CMP	PL-141	LY33-6007	LYC7-2506
OS PL/1 RESIDENT LIB	LM-441	LY33-6008	LYC7-2504
OS PL/1 TRANS LIB	LM-541	LY33-6009	LYC7-2505
OS/VIDEO/370	RC-500		LYC7-5048
TSO COBOL PROMPTER	CP-101	LY28-6406	
<u>5735</u>			
EMULATION SUPPORT	SC1	SY30-3004	
		SY30-3006	
NCP/VS	SC2		SJD2-4125
NCP3/VTAM	SC3	SY30-3013	SJD2-4126
<u>5736-DQS+ DQS/V5_PP</u>			
AUTO REPORT	RG-1AR	LY21-0014	
CICS/DOS ENTRY	XX-600		LY80-0724
CICS/DOS STANDARD	XX-700		LY80-0735
DOS F/ANS COBL LIB 3	LM-201		LYC7-5031
DOS FORT/7	FO1		
DOS PL/1 OPT COMP	PL-161	LY33-6010	LYC7-2503
DOS PL/1 RES LIB	LM-461	LY33-6011	LYC7-2501
DOS PL/1 TRANS LIB	LM-561	LY33-6012	LYC7-2502
DOS RPG II	RG-101	LY21-0014	LYB1-0450
DOS/FULL ANS COBL V3	CB-201	LY28-6412	LYC7-5030
DOS/VIDEO/370	RC-300		LYC7-5049

PAGE OF : G229-2228-20
 REVISED : OCTOBER 1977
 BY TNL : GN25-0005-3

PROGRAM TITLE PROGRAM PLM NUMBER(S) MICROFICHE NO.

5740-PP

CICS/OS/V5	XX-100	LY20-8006	LY80-8008
DASDR	UT-1	LY20-8049	LJ86-0002
GIS/V5	XX-700		
IMS/V5	XX-210	LY20-8004	LJ86-0004
		LY20-8005	LY80-8018
		LY20-8041	LY80-8016
		LY20-8050	LY80-8017
JES2 NJE	XR8	LY24-6001	LY88-0838
OS/V5 COBOL COMPILER	CB1	LY28-6486	LYC7-5052
OS/V5 COBOL LIBRARY	LM1	LY28-6425	LYC7-5052
OS/V5 SORT MERGE	SM1	LY33-8042	LYC7-0904
OS/V51 VSPC	XR5	LY20-8036	LY80-8043
OS/V52 VSPC	XR6	LY20-8036	LY80-8045
RACF	XXH	LY28-0730	SJ82-9503
RMF	XXM	LY28-0739	SJ82-9500
TCAM IMS	XXC	LY20-2126	LY80-2221
TCS-AF	XXD	LY20-2219	LY80-2257
TSO CMD PKG	XT6	LY28-0749	SJ82-9501

5741-OS/V51

ASSEMBLER XF	SC1-03	SY33-8041	SJD2-2034
BTAM	SC1-20	SY27-7246	SJD2-2049
CATALOG	SC1-D3		SJD2-2099
CHECKPOINT/RESTART	SC1-09	SY26-3820	SJD2-2054
COMMANDS	SC1-B8		SJD2-2022
COMMON SUPV MACROS	SC1-CN		
CONDITIONAL ASM SWTH	SC1-CS	SY33-8041	
CRJE	SC1-0A	GY30-2011	
CTS-RETAIL HCST	SC1-26		
CTS-SPPS	SC1-28	SY30-3024	SJD2-4191
DADSM	SC1-D4		SJD2-2060
DAM	SC1-D7	SY26-3836	SJD2-2062
DASD ERP	SC1-CA	SY24-5156	SJD2-2067
DIDOC5	SC1-C4		SJD2-2030
EXT PREC FLT PT SIM	SC1-CP	SY24-5155	
FETCH	SC1-C7	SY24-5155	SJD2-2055
GAM	SC1-G0	SY27-7240	SJD2-2031
		SY27-7241	
GSP	SC1-07	SY27-7242	SJD2-2032
GTF	SC1-11	SY28-0635	SJD2-2041
HMAPTELE	SC1-16	SY28-0635	SJD2-2045
HMASMP	SC1-30	SY28-0685	SJD2-2120
HMASPZAP	SC1-12	SY28-0635	SJD2-2042
HMBLIST	SC1-14	SY28-0635	SJD2-2076
HMDPRDMP	SC1-13	SY28-0635	SJD2-2043
HMDPRDMP/EDIT	SC1-18		SJD2-2106
HMSADMP	SC1-15	SY28-0635	SJD2-2044
IBCDASDI	SC1-11	SY35-0005	SJD2-2078
IBCDMPRS	SC1-10	SY35-0005	SJD2-2077
ICAPRTBL	SC1-12	SY35-0005	SJD2-2079
IDCAMS	SC1-DK	SY35-0008	SJD2-2114

<u>PROGRAM TITLE</u>	<u>PROGRAM</u>	<u>PLM NUMBER(S)</u>	<u>MICROFICHE NO.</u>
IEBCOMPR	SC1-UK	SY35-0005	SJD2-2089
IEBCOPY	SC1-U6	SY35-0005	SJD2-2085
IEBDG	SC1-UJ	SY35-0005	SJD2-2091
IEBEDIT	SC1-U9	SY35-0005	SJD2-2102
IEBGENER	SC1-U7	SY35-0005	SJD2-2086
IEBISAM	SC1-UH	SY35-0005	SJD2-2090
IEBPTPCH	SC1-UA	SY35-0005	SJD2-2088
IEBTCRIN	SC1-UG	SY35-0005	
IEBUPOTE	SC1-U8	SY35-0005	SJD2-2087
IEHATLAS	SC1-UF	SY35-0005	SJD2-2082
IEHDASDR	SC1-U0	SY35-0005	SJD2-2080
IEHINIT	SC1-UD	SY35-0005	SJD2-2097
IEHIOSUP	SC1-U1	SY35-0005	SJD2-2081
IEHLIST	SC1-U2	SY35-0005	SJD2-2048
IEHMOVE	SC1-UC	SY35-0005	SJD2-2092
IEHPROGM	SC1-U3	SY35-0005	SJD2-2096
IEHSTATR	SC1-UE	SY35-0005	
IMCJOBQD	SC1-I7	SY28-0635	
INITIATOR/DSO	SC1-B6		SJD2-2020
IMCOSJQD	SC1-I9		SJD2-2129
INPUT STREAM	SC1-B1		SJD2-2015
INTERPRETER	SC1-B9		SJD2-2023
IOS	SC1-C3	SY24-5156	SJD2-2001
IPL	SC1-C1	SY24-5155	SJD2-2000
		SY24-5160	
ISAM	SC1-D8		SJD2-2063
ISSP	SC1-BK		SJD2-2122
IVP	SC1-08		
I O DEVICE ALLOCATION	SC1-B4		SJD2-2018
JAM	SC1-D9		SJD2-2064
JEC5	SC1-80		SJD2-2014
JES COMPAT INTERFACE	SC1-DB	SY26-3840	SJD2-2074
JOB LIST MGR	SC1-BJ		SJD2-2140
LINKAGE EDITOR	SC1-04	SY26-3815	SJD2-2068
LOADER	SC1-05	SY26-3814	SJD2-2069
MAPPING MACROS	SC1-01		SJD2-2003
MICR	SC1-D6		SJD2-2061
MSC TABLE CREATE	SC1-DQ	SY35-0016	SJD2-2141
MSC TRACE	SC1-DT	SY35-0014	SJD2-2144
MSS COMMUNICATOR	SC1-DP	SY35-0012	SJD2-2132
MSS DATA ANALYSIS	SC1-DS	SY28-0669	SJD2-2143
MSS SERVICES	SC1-DU	SY35-0015	SJD2-2145
MSS SPACE MANGE	SC1-DR	SY35-0012	SJD2-2142
NIP	SC1-C8	SY24-5160	SJD2-2111
OBR/EREP/RDE	SC1-CD	SY28-0669	SJD2-2160
OCR	SC1-D5		
OLTEP	SC1-06	SY28-0662	SJD2-2046
OPEN/CLOSE/EDV	SC1-D1	SY26-3839	SJD2-2058
OUTPUT STREAM CTL	SC1-B2		SJD2-2016
OVERLAY SUPERVISOR	SC1-C2	SY24-5155	SJD2-2056
PAM	SC1-D2	SY26-3840	SJD2-2059
PASSWORD PROTECT	SC1-DC	SY26-3836	
QUEUE MANAGER	SC1-B5		SJD2-2019
RES	SC1-B6	SY28-6849	SJD2-2105
RES ACCOUNT UTILITY	SC1-BC		SJD2-2107
RMS	SC1-CE	GY27-7239	SJD2-2033
RSTRT RDR/DSDR PROC	SC1-BD		
SAM	SC1-D0	SY26-3840	SJD2-2057
SCHED INITIALIZATION	SC1-BG		
SCHEDULER SMF	SC1-D0		SJD2-2009
SCHEDULER SYSGEN	SC1-S5		

PAGE OF : G229-2228-20
 REVISED : OCTOBER 1977
 BY TNL : GN25-0005-3

PROGRAM TITLE	PROGRAM	PLM NUMBER(S)	MICROFICHE NO.
SERVICE AIDS SYSGEN	SC1-S6	SY28-0635	
SGIEM402	SC1-UX	SY35-0005	
SMF	SC1-02	SY24-5155	SJD2-2094
SSS (BASE IND SUPT)	SC1-SS	SY30-3017	SJD2-2133 SJD2-4180
STARTER SYSTEM 3330	SC1-S2		
SUPERVISOR	SC1-C5	SY24-5155	SJD2-2002
SUPERVISOR SYSGEN	SC1-S4		
SYSGEN	SC1-S1		SJD2-2128
SYSTEM LOG	SC1-BE		
SYSTEM RESTART	SC1-B3		SJD2-2017
TAPE/3851 ERP/VES	SC1-CC	SY24-5156	SJD2-2101
TCAM	SC1-21	SY30-2049 SY30-2069	SJD2-2124
TCAM DIRECT	SC1-21	SY30-3032	SJD2-2161
TERMINATION	SC1-B7		SJD2-2021
TOLTEP	SC1-0C	SY28-0664	SJD2-2134
UNIT RECORD ERP	SC1-C8	SY24-5156	SJD2-2010
VSAM	SC1-DE	SY26-3841 SY35-0008	SJD2-2118
VTAM	SC1-23	SY27-7256 SY27-7257 SY27-7266	SJD2-2113
WTP	SC1-BF		SJD2-2026
3344/3350 AP-1	SC1-31	SY26-3851	SJD2-2138
3505/3525 RDR/PCH SP	SC1-00		SJD2-2108
3540	SC1-DN	SY24-5166	SJD2-2131
3600 HOST SUPPORT	SC1-24	SY27-7261	
3851 ERP	SC1-CI		SJD2-2139
3886 OCR	SC1-DL		SJD2-2116
3890 DOC PROC	SC1-DF		SJD2-2115
5742=OS/V52			
ALLOCATION	SC1-B4		SJD2-0350
AMAPTELE	SC1-16	SY28-0643	SJD2-0470
AMASPZAP	SC1-12	SY28-0643	
AMBLIST	SC1-14	SY28-0643	SJD2-0880
AMDPRDMP	SC1-13	SY28-0643	SJD2-0450
AMDPRDMP/EDIT	SC1-18	SY28-0643	
AMDSADMP	SC1-15	SY28-0643	SJD2-0460
ASSEMBLER XF	SC1-03	SY33-8041	SJD2-0890
BLDL LIST	SC1-CT		
BTAM	SC1-20	SY27-7246	SJD2-0560
CATALOG	SC1-D3		SJD2-0080
CHECKPOINT/RESTART	SC1-09	SY26-3820	SJD2-0820
COMMANDS	SC1-B8		SJD2-0390
COMMON SUPV MACROS	SC1-CN		
CONDITIONAL ASM SWTH	SC1-CS	SY33-8041	
DADSM	SC1-D4		SJD2-0840
DAM	SC1-D7		SJD2-0690
DASD ERP	SC1-CA	SY26-3823	SJD2-0710
DIDOCs	SC1-C4		SJD2-0300
EXT PREC FLT PT SIM	SC1-CP		SJD2-0140
EXTENDED SERVICE RTR	SC1-CF		
FETCH	SC1-C7	SY27-7244	SJD2-0650
GAM	SC1-G0	SY27-7240 SY27-7241	SJD2-0290
GSP	SC1-07	SY27-7242	SJD2-0280
GTF	SC1-11	SY28-0643	SJD2-0430
HMASMP	SC1-30	SY28-0685	GJD1-1100

PROGRAM TITLE	PROGRAM	PLM NUMBER(S)	MICROFICHE NO.
IBCDASDI	SC1-I1	SY35-0005	
IBCDMPRS	SC1-I0	SY35-0005	
ICAPRTBL	SC1-I2	SY35-0005	
IDCAMS	SC1-DK	SY35-0008	SJD2-1220
IEBCOMPR	SC1-UK	SY35-0005	SJD2-0210
IEBCOPY	SC1-U6	SY35-0005	SJD2-0170
IEBDG	SC1-UJ	SY35-0005	SJD2-0230
IEBEDIT	SC1-U9	SY35-0005	SJD2-0050
IEBGENER	SC1-U7	SY35-0005	
IEBISAM	SC1-UH	SY35-0005	
IEBPTPCH	SC1-UA	SY35-0005	SJD2-0200
IEBTCRIN	SC1-UG	SY35-0005	SJD2-0580
IEBUPDTE	SC1-U8	SY35-0005	SJD2-0190
IEHATLAS	SC1-UF	SY35-0005	SJD2-0780
IEHDASDR	SC1-U0	SY35-0005	SJD2-0770
IEHINIT	SC1-UD	SY35-0005	SJD2-0020
IEHLIST	SC1-U2	SY35-0005	
IEHMOVE	SC1-UC	SY35-0005	SJD2-0160
IEHPRGDM	SC1-U3	SY35-0005	SJD2-0070
IEHSTATR	SC1-UE	SY35-0005	SJD2-0030
INITIATOR	SC1-B6		SJD2-0370
INTERPRETER	SC1-B9		SJD2-0400
IOS	SC1-C3	SY26-3823	SJD2-0700
IPL	SC1-C1		
ISAM	SC1-D8		SJD2-0810
IYP	SC1-08		
LINK LOADGO PROMPTER	SC1-T5	SY28-0651	SJD2-0850
		SY28-0652	
		SY28-0650	
LINKAGE EDITOR	SC1-04	SY26-3815	SJD2-0860
LOADER	SC1-05	SY26-3814	SJD2-0870
MAPPING MACROS	SC1-01		
MICR	SC1-D6		SJD2-0680
QBR/ERP/RDE	SC1-CD		SJD2-0420
OCR	SC1-D5		SJD2-0600
OLTEP	SC1-06		SJD2-0550
OPEN/CLOSE/EOV	SC1-D1		SJD2-0830
OVERLAY SUPERVISOR	SC1-C2	SY27-7244	SJD2-0640
PAM	SC1-D2		SJD2-0670
PASSWORD PROTECT	SC1-DC		
QUEUE MANAGER	SC1-B5		SJD2-0360
REL LEVEL ID MACROS	SC1-0B		
RMS	SC1-CE	SY27-7239	SJD2-0270
SAM	SC1-D0	SY26-3840	SJD2-0660
SCHEDULER SMF	SC1-00		
SCHEDULER SYSGEN	SC1-S5		
SERVICE AIDS SYSGEN	SC1-S6		
SGIEH402	SC1-UX	SY35-0005	
SMF	SC1-02		SJD2-0010
STARTER SYSTEM 2314	SC1-S3		
STARTER SYSTEM 3330	SC1-S2		
SUPERVISOR	SC1-C5	SY27-7244	SJD2-0260
SYSGEN	SC1-S1	SY28-0643	
SYSOUT WRITER	SC1-B2		SJD2-0790
SYSTEM RESTART	SC1-B3		SJD2-0330
TAPE ERP/VES	SC1-CC	SY26-3823	SJD2-0040
TCAM	SC1-21	SY30-2040	SJD2-0570
		SY30-2049	
TCAM DIRECT	SC1-21	SY30-3032	SJD2-7200
TERMINATION	SC1-B7		SJD2-0380
TSO DATA MANAGEMENT	SC1-T3	SY30-2049	SJD2-0740
		SY28-0651	SJD2-7205
		SY28-0650	

PAGE OF : G229-2228-20
 REVISED : OCTOBER 1977
 BY TNL : GN25-0005-3

PROGRAM TITLE	PROGRAM	PLM NUMBER(S)	MICROFICHE NO.
TSO EDIT	SC1-T0	SY28-0651 SY33-8548 SY28-0653 SY28-0659 SY28-0650	SJD2-0240
TSO SCHEDULER	SC1-T4	SY28-0650 SY28-0653 SY28-0651 SY28-0659	SJD2-0410
TSO SUPERVISOR	SC1-T7	SY28-0649 SY28-0651 SY28-0650	SJD2-0320
TSO TCAM SUBROUTINE	SC1-T8	SY28-0651 SY28-0650 SY30-2049	SJD2-0730
TSO TEST	SC1-T1	SY28-0651 SY35-0004	SJD2-0130
TSO TRACE	SC1-T9	SY28-0650 SY28-0649 SY28-0651 SY28-0650	
TSO UTILITIES	SC1-T2	SY28-0651 SY28-0652 SY28-0650	SJD2-0120
UNIT RECORD ERP	SC1-CB	SY26-3823	SJD2-0720
VSAM	SC1-DE		SJD2-1220
VTAM	SC1-23		SJB1-0461
3505/3525 RDR/PCH SP	SC1-DD	SY26-3832	SJD2-0590
3735 MACROS/UTILITY	SC1-22		

5744-05/VS1, 05/VS2, DOS

BATCH TRANSFER PROGRAM	CG1,CG2,CH1	SY33-8901	SYC7-1702 SYC7-1703 SYC7-1704
DISK COPY PROGRAM	BJ1,BL1		
DISK INTEL SYSTEM	BK1	GY34-0019	GJD1-1795
DOS EMULATOR	AS1	SY33-7015	SYC7-2101
OS/VS ASM/7	AB1		GJD1-1796 GJD1-1797
OS/VS FORMAT/7	AD1		GJD1-1796 GJD1-1797
OS/VS LINK/7	AC1	GY34-0008	GJD1-1796 GJD1-1797
OS/VS MACLIB/R	AA1	GY34-0010 GY34-0012 GY34-0018	GJD1-1790 GJD1-1794
SYSTEM SUPPORT PROGRAM	AN1	SY30-3004 SY30-3006	GJD2-4118
1285/1287/1288 D M	AE1		
1401 EMULATOR	AH1	SY33-7016	
1410 EMULATOR	AG1		
3735 MACROS & UTIL	AZ1		
3790 HOST SUPPORT	BZ1,B22	SY27-7264	SJB1-0022

<u>PROGRAM TITLE</u>	<u>PROGRAM</u>	<u>PLM_NUMBER(S)</u>	<u>MICROFICHE NO.</u>
<u>5745-DQS/V5</u>			
ASSEMBLER PHK	SC-ASM	SY33-8567	SYC7-1934
ATTENTION ROUTINES	SC-AIT	SY33-8553	SYC7-1932
BTAM	SC-BTM	SY27-7251	SYC7-1935
CHECKPOINT/RESTART	SC-CKR	SY33-8559	SYC7-1936
CTS-RETAIL HOST	SC-RTL		SJD2-4190
CTS-SPPS	SC-SPP	SY30-3024	SYC7-1944
COMP I/O MODULES	SC-IOM	SY33-8560	SYC7-1937
DIR ACC METHOD	SC-DAM	SY33-8561	SYC7-1938
DISK EREP	SC-DKE	SY33-8552	SYC7-1966
DISKETTE IOCS	SC-DIO	SY33-8560	SYC7-1939
DISP OPER CONSOLE	SC-DOC	SY33-8553	
		SY33-8560	
DISTRIBUTION PROGRAM	SC-DIS		SYC7-1964
EREP	SC-ERP	SY33-8554	SYC7-1942
INDEX SEQ FILE MGMT	SC-ISM	SY33-8561	SYC7-1947
IOCS/DEV IND I/O	SC-IOX	SY33-8560	SYC7-1945
		SY33-8552	
IPL BUFFER LOAD	SC-IPL	SY33-8555	SYC7-1946
JOB CONTROL	SC-JCL	SY33-8555	SYC7-1950
LIB, SERV & MAINT	SC-LBR	SY33-8557	SYC7-1949
LINKAGE EDITOR	SC-LNK	SY33-8556	SYC7-1950
MAG TAPE IOCS	SC-TAP	SY33-8560	SYC7-1960
MAINTAIN SYS HIST	SC-UTS	SY33-8558	SYC7-0451
MCR IOCS	SC-MCR	SY33-8560	SYC7-1951
MOD 20 EMULATOR	SC-E20	SY33-8575	SYC7-1943
OCR IOCS	SC-OCR	SY33-8560	SYC7-1952
OLTEP	SC-OLT	SY33-8568	SYC7-1953
PAPER TAPE IOCS	SC-PTP	SY33-8560	SYC7-1955
PD AIDS	SC-PDA	SY33-8554	SYC7-1954
POWER	SC-PWR	SY33-8570	SYC7-1976
		SY33-8572	
		SY33-8576	
		SY33-8577	
		GC33-5405	
QTAM	SC-QTM	SY27-7249	SYC7-1957
RMSR	SC-RMS	SY33-8552	SYC7-1958
SEQUENT DISK I/O	SC-DSK	SY33-8560	SYC7-1940
SSS (BASE IND SUPT)	SC-SSS	SY30-3017	SYC7-1970
SUPERVISOR	SC-SUP	SY33-8551	SYC7-1959
SYSTEM UTILITIES	SC-UTL	SY33-8558	SYC7-1962
TAPE EREP	SC-TPE	SY33-8552	SYC7-1961
TOLTEP	SC-TLT	SY28-0664	SYC7-1969
VSAM	SC-VSM	SY33-8562	SYC7-1963
3344/3350 AP-1	SC-APC	SY26-3852	SYC7-0450
VSAM SERVICE PROG	SC-AMS	SY33-8564	SYC7-1933
VTAM	SC-VTM	SY27-7256	SYC7-1968
		SY27-7262	SJD2-4122
		SY27-7263	
		SY27-7265	
		SY27-7270	
3600 RSS HOST SUPT	SC-124	SY27-7261	SYC7-1941
1401/1410 EMULATOR	SC-EML	SY33-8573	SYC7-2107
		SY33-8574	
<u>5746 DQS/V5 PP</u>			
ATTENTION ROUTINES	E2-AIT	LY33-9063	LYC7-0453
		LY33-9064	
DISP OPER CONSOLE	E2-DOC	LY33-9064	LYC7-0454
IPL BUFFER LOAD	E2-IPL	LY33-9066	LYC7-0455
JOB CONTROL	E2-JCL	LY33-9066	LYC7-0456

PAGE OF : G229-2228-20
 REVISED : OCTOBER 1977
 BY TNL : GN25-0005-3

PROGRAM TITLE	PROGRAM	PLM NUMBER(S)	MICROFICHE NO.
LIBRARIAN	E2-LBR	LY33-9068	LYC7-0457
LINKAGE EDITOR	E2-LNK	LY33-9067	LYC7-0458
PDAIDS	E2-PDA	LY33-9065	LYC7-0459
SUPERVISOR	E2-SUP	LY33-9063	LYC7-0460
CICS DOS/V5 EXT	XXB		LYB0-2218
CICS/DOS/V5	XX3	LY20-8007	
DL/1 DOS	XX1	LY12-5016	LYB0-0839
DL/1 ENTRY	XX7	LY12-5017	LYA2-5213
DOS/V5 FULL CBL/LIB	CB1	LY28-6423	LYC7-5050
DOS/V5 FULL LIB	LM4	LY28-6424	LYC7-5050
DOS/V5 SORT/MERGE	SM1	LY33-8038	LYC7-0903
DOS/V5 VSPC	XR3	LY20-8039	LYC7-0905
FOR 4 LIB DOS 3330	LM3	GY28-6394	LYB0-8046
			LYC7-5044
<u>5747-DOS/V5-SYS/7</u>			
BATCH TRANSFER PROG	BW1	SY33-8900	SYC7-1701
DOS/V5 ASM/7	AB1	GY34-0007	GJD1-1787
DOS/V5 FORMAT/7	AD1	GY34-0007	GJD1-1787
DOS/V5 LINK/7	AC1	GY34-0009	GJD1-1787
DOS/V5 MACLIB/R	AE1	GY34-0010	GJD1-1790
		GY34-0012	GJD1-1794
		GY34-0018	
3600 HOST SUPPORT	BR1	SY27-7261	
3705 DOS/V5 ASSEMBLER	AG1	SY30-3004	
		SY30-3006	SJD2-4132
3735 MACROS & UTIL	AZ1		
3790 HOST SUPPORT	BQ1	SY27-7264	GJB1-0001
<u>5748-PP</u>			
VS APL	AP1	LY20-8032	LYB0-8040
VS/BASIC	XX1	LY28-6422	LYC7-5051
VSPC FORTRAN	F02	LY20-8031	LYB0-8044
<u>5749-VM/370</u>			
ASSEMBLER	SC-103	SY33-8041	SYB0-0901
CMS	DMS		SYB0-0901
CP	DMK	SY20-0882	SYB0-0900
		SY25-7701	
IPCS	DMM-00		SYC0-9001
RSCS	DMT	SY20-0883	SYC0-9000
<u>5752-DOS/V52 RELEASE 2 AND ABOVE</u>			
ACCESS METHOD SERVICE	SC1-DK	SY35-0010	SJD2-4710
ALLOCATION	SC1-B4		SJD2-4260
AMAPTELE	SC1-16	SY28-0643	
AMASPZAP	SC1-12	SY28-0643	SJD2-5230
AMBLIST	SC1-14	SY28-0643	SJD2-5250
AMDPRDMP	SC1-13	SY28-0643	SJD2-5240
AMDPRDMP/EDIT	SC1-18	SY28-0643	SJD2-5280
AMDSADMP	SC1-15	SY28-0643	SJD2-5260
ASSEMBLER XF	SC1-03	SY33-8041	SJD2-5150
AUX STOR MANAGER	SC1-CW		SJD2-4490
BLOCK PROCESSOR	SC1-DA	SY26-3825	SJD2-4620
BTAM	SC1-20	SY27-7246	SJD2-5290
CATALOG CNTRLR 3	SC1-DH	SY35-0011	SJD2-4690
CHECKPOINT/RESTART	SC1-09	SY26-3820	SJD2-5200

<u>PROGRAM TITLE</u>	<u>PROGRAM</u>	<u>PLM NUMBER(S)</u>	<u>MICROFICHE NO.</u>
COMM TASK	SC1-CK		SJD2-4410
COND ASM SWITCH	SC1-CS		
CONTENTS SUPERVISOR	SC1-CJ		SJD2-4400
CONVERTER/INTERPRETER	SC1-B9		SJD2-4310
CTS-RETAIL HOST	SC1-26		
CTS-SPPS	SC1-28	SY30-3024	
DADSM	SC1-D4	SY26-3828	SJD2-4770
DAM	SC1-D7		SJD2-4800
DASD ERP	SC1-CA	SY26-3823	SJD2-4330
DIDDCS	SC1-C4		SJD2-4560
EXCP	SC1-C6	SY26-3823	SJD2-4580
EXT PREC FLT PNT	SC1-CP		
EXTENDED SVC ROUTER	SC1-CF		
EXTERNAL WRITER	SC1-B2	SY28-0622	SJD2-4240
FETCH	SC1-C7		SJD2-4590
GAM	SC1-G0	SY27-7241	SJD2-4820
		SY27-7260	
GSP	SC1-07		
GTF	SC1-11	SY27-7242	SJD2-5220
		SY28-0643	SJD2-4800
HMASMP	SC1-30	SY28-0685	SJD2-5330
IBCDASDI	SC1-I1	SY35-0005	SJD2-4840
IBCDMPRS	SC1-I0	SY35-0005	SJD2-4830
ICAPRTBL	SC1-I2	SY35-0005	
IEABLD00	SC1-CT		
IEBCOMPR	SC1-UK	SY35-0005	
IEBCOPY	SC1-U6	SY35-0005	
IEBDG	SC1-UJ	SY35-0005	SJD2-5000
IEBEDIT	SC1-U9	SY35-0005	SJD2-5090
IEBGENER	SC1-U7	SY35-0005	
IEBISAM	SC1-UH	SY35-0005	SJD2-4990
IEBTPCH	SC1-UA	SY35-0005	
IEBTRIN	SC1-UG	SY35-0005	
IEBUPDTE	SC1-U8	SY35-0005	SJD2-5080
IEHATLAS	SC1-UF	SY35-0005	SJD2-4970
IEHDASDR	SC1-U0	SY35-0005	SJD2-5030
IEHINITT	SC1-UD	SY35-0005	SJD2-4950
IEHLIST	SC1-U2	SY35-0005	SJD2-5040
IEHMOVE	SC1-UC	SY35-0005	SJD2-4940
IEHPROGM	SC1-U3	SY35-0005	SJD2-5050
IEHSTATR	SC1-UE	SY35-0005	
IEHUCAT	SC1-UY	SY35-0005	
INITIATOR	SC1-86		SJD2-4280
IOS	SC1-C3	SY26-3823	SJD2-4550
IPL	SC1-C9	SY28-0623	
ISAM	SC1-D8	SY26-3833	SJD2-4810
IVP	SC1-08		
JES 2	SC1-BH	SY28-0622	SJD2-4230
		SY24-6000	
JES 3	SC1-BA	SY28-0612	
LINK LOADGO PROMPTER	SC1-T5		
LINKAGE EDITOR	SC1-04	SY26-3815	SJD2-5160
LOADER	SC1-05	SY26-3814	
M S COMMANDS	SC1-B8		SJD2-4790
MAPPING/SUPVR MACROS	SC1-01		SJD2-5130
MICR	SC1-D6	GY21-0012	SJD2-4790
MF/1	SC1-CQ		SJD2-4450

PAGE OF : G229-2228-20
 REVISED : OCTOBER 1977
 BY TNL : GN25-0005-3

<u>PROGRAM TITLE</u>	<u>PROGRAM</u>	<u>PLM NUMBER(S)</u>	<u>MICROFICHE NO.</u>
M P RECONFIGURATION	SC1-CZ		SJD2-4520
MSC TABLE CREATE	SC1-DQ	SY35-0016	SJD2-5440
MSC TRACE	SC1-DT	SY35-0014	SJD2-5400
MSS COMMUNICATOR	SC1-DP	SY35-0013	SJD2-5370
MSS DATA ANALYSIS	SC1-DS	SY20-0678	SJD2-5390
MSS SERVICES	SC1-DU	SY35-0015	SJD2-5410
MSS SPACE MANGE	SC1-DR	SY35-0012	SJD2-5380
NIP	SC1-C8	SY28-0623	SJD2-4600
O/C/EDV	SC1-D1	SY26-3827	SJD2-4740
OBR/EREP/RDE	SC1-CD	SY28-0678	SJD2-4350
OCR	SC1-D5		SJD2-4780
OLTEP	SC1-06		SJD2-5180
OVERLAY SUPERVISOR	SC1-C2		
PAM	SC1-D2	SY26-3828	SJD2-4750
PASSWORD PROTECT	SC1-DC	SY26-3827	SJD2-4640
POWER WARNING FEATURE	SC1-0E		
RADIX PARTITION TREE	SC1-CY		
REAL STOR MANAGER	SC1-CR		SJD2-4460
RECOVERY TERMINATION	SC1-CM		SJD2-4430
REGION CONTROL TASK	SC1-CU		SJD2-4470
RMS	SC1-CE	SY27-7250	SJD2-4360
SAM	SC1-D0		SJD2-4730
SAM SUBSYSTEM	SC1-DB		SJD2-4630
SCHEDULER RESTART	SC1-B3		SJD2-4250
SCHEDULER SYSGEN	SC1-S5		
S SYSGEN SC1-S6			
SERVICE AID			
SGIEH402	SC1-UX	SY35-0005	
SMF	SC1-02	SY28-0626	SJD2-5140
SSS	SC1-S5	SY30-3017	SJD2-2133
SMF SCHEDULER	SC1-00	SY28-0626	SJD2-5120
SUPERVISOR CONTROL	SC1-C5		SJD2-4570
SUPERVISOR SYSGEN	SC1-S4		
SVC I09	SC1-C6		
SWA MANAGER	SC1-B5		SJD2-4270
SYSGEN	SC1-S1		
SYSTEM RESOURCE MGR	SC1-CX		SJD2-4500
TAPE ERP/VES	SC1-CC	SY26-3823	SJD2-4340
TASK MANAGER	SC1-CL		SJD2-4420
TCAM	SC1-21	SY30-2040	SJD2-5300
TCAM DIRECT	SC1-21	SY30-3032	
TIMER SUPERVISOR	SC1-CV		SJD2-4480
TOLTEP	SC1-0C	SY28-0664	
TSO EDIT	SC1-T0	SY33-8548	SJD2-4860
TSO SCHEDULER	SC1-T4	SY28-0626	SJD2-4900
TSO TCAM SUBROUTINES	SC1-T8		SJD2-4920
TSO TEST	SC1-T1	SY35-0004	SJD2-4870
TSO TI0C	SC1-T3		SJD2-4890
TSO UTILITIES	SC1-T2		SJD2-4880
U R ERP	SC1-CB	SY26-3823	SJD2-4330

PROGRAM TITLE	PROGRAM	PLM NUMBER(S)	MICROFICHE NO.
VBP	SC1-DG	SY26-3834	SJD2-4680
VIRT STOR MANGR	SC1-CH		SJD2-4390
VSAM & VSAM CATALOG	SC1-DE		SJD2-4660
VTAM	SC1-23	SY27-7256 SY27-7267 SY27-7272 SY28-0621 SY26-3834	SJD2-5320
WINDOW INTERCEPT	SC1-DJ		
2314 STARTER	SC1-S3		
3330 STARTER	SC1-S2		
3340/3350 AP-1	SC1-31		SJB6-6002
3505/3525 RDR/PCH	SC1-DD		SJD2-4650
3540	SC1-DN		SJD2-5360
3600 HOST SUPPDR	SC1-24	SY27-7261	SJD2-5430
*3886 OCR	SC1-DL		
3890 DOCUMNT PRDC	SC1-DF		SJD2-4670
<u>5799-PSHRPQ-RPQ</u>			
EMUL B100/200/300	AAC		
EMULATOR H120/200	AAB		
FILM RDR/RECORDER	WAA		
FORTRAN H EXT PLUS	AAW		LYC7-5042
HASP NETWORKING	ATC	LY20-2340	
MLTA TERM ADAPT	WFK	SY21-0527	
PRPQ	AAR		
PRPQ	AAT		
PSHRPQ	WAF		
S/3 MOD6 1017 IOCS	WDF		
S/3 MOD6 1018 IOCS	WDL		
S/3 M10 BSCA MODIF	WHG		
S/3 M10 C 1017 IOCS	WAD		
S/3 M10 C 1018 IOCS	WAM		
S/3 M10 C 2501 ATT	WCE		
S/3 M10 D 1017 IOCS	WAE		
S/3 M10 D 1018 IOCS	WAN		
S/3 M10 D MLTA IOCS	WAU		SYC7-1111
S/3 M10 D 2501 ATT	WCF		
S/3 M10 D 2956 ATT	WGX		
S/3 M10 INT. TIMER	WGY		
S/3 M10 1017/1442	WDP		
S/3 M10 1018/1441	WFD		
S/3 M10 2ND 1403 ATT	WHL		
S/3 M10 2793/2797	WDT		
S/3 M12 MLTA IOCS	WKH	SY21-0527	SYC7-1137
S/3 M15 D MLTA IOCS	WLD		SYC7-1143
S/3 M15 MLTA IOCS	WFK	SY21-0527	SYC7-1127
S/3 M15 1017 IOCS	WHP		
S/3 M15 1018 IOCS	WHT		
S/7 CH ATT-OS/DOS	WCB	SY34-0517	
S/7 TPMM BSC	WFG	SY34-0542	
S/7 3340 ATT	WJH	SY09-1200	GJD1-1804
S/7 3340 ATT	WJJ	SY09-1200	GJD1-1804
S/7 3340 ATT	WJK	SY09-1200	GJD1-1804
S/7 3340 ATT	WJX	SY09-1200	GJD1-1804
S/7 3340 ATT	WJY	SY09-1200	GJD1-1804
VM/370 NETWORKING	ATA	LY20-2342	
VM/370 RESOURCE MGT.	ARQ	LY20-1996	
2740/2968 A/V CTL PK	WAB		
3350/3330 MOD II	ARG	LY20-8047	LJB6-0001
3705 ASC II TRANS	AFZ		

Index

- alignment, CNOP, 2-4
- alter main storage
 - see CPU manual procedures
- alter PSW
 - see CPU manual procedures
- alter registers
 - see CPU manual procedures
- ANSI-defined printer control characters, 2-11
- assembler instructions, 2-5
- assign alternate track data cell utility, 6-1

- bibliography 1, 8-1
- bibliography 2, 8-2
- binary powers table, 2-16

- card punch
 - I/O command code, 2-6
 - 3525 error recovery, 5-28
 - 3525 stop indications and restart procedures, 5-20
- card reader
 - general hints, 5-11
 - I/O command code, 2-6
 - 2501 error and restart procedures, 5-12
 - 3504/3505 restart procedures, 5-14
 - 3505/3525 restart procedures, 5-20
- channel address word (CAW), 2-13
- channel command word (CCW), 2-13
- channel logout (hex B0), 2-14
- channel status word (CSW), 2-13
- checkpoint restart OS/VS1, 5-26
- checkpoint restart OS/VS2, 5-27
- clear data cell utility, 6-1
- clear disk utility, 6-1
- clear main storage
 - see CPU manual procedures
- CMS operator commands, 4-149
- CNOP alignment, 2-4
- code translation table, 2-8
- codes for interruptions, 2-14
- commands
 - see operator commands
- condition codes, 2-4
- console file S/370 Mod 125, 5-33
- console printer, I/O command code, 2-6
- constants, summary of, 2-5
- control (k) commands, 4-164, 4-171
 - DOS/VS DOC commands, 4-164
 - OS/VS display console commands, 4-171

- control register allocation, 2-12
- control register fields, 2-12
- copy and restore disk on data cell utility, 6-1
- copy and restore diskette utility, 6-2
- CP operator commands, 4-128
- CPU manual procedures for
 - Mod 115, 3-3
 - Mod 125, 3-3
 - Mod 135, 3-6
 - Mod 145, 3-8
 - Mod 155, 3-11
 - Mod 158, 3-13
 - Mod 165, 3-15
 - Mod 168, 3-18
 - Mod 195, 3-22
- CRJE system operator commands, 4-50
- DASD, I/O command codes for, 2-7
- day of year, formula for, 4-168
- deblock utility, 6-2
- definitions of substitutional operands, 4-60
- disk drive - 3340, 5-31
- diskette, 5-33
- display console
 - 3270, 5-49
 - 3277, 5-50
 - DOS/VS DOC commands, 4-164
 - OS/VS display console commands, 4-171
 - OS/VS display console operation (Mod 158), 5-54
 - starting DOS/VS with DOC, 4-161
 - starting OS/VS with, 5-52
- display screen areas
 - Mod 125, 5-49
 - Mod 158, 5-50
 - Mod 168, 5-51
- display main storage
 - see CPU manual procedures
- display PSW
 - see CPU manual procedures
- display registers
 - see CPU manual procedures
- DITTO DOS/VS utility, 6-3, 6-6
- DOS/VS IPL commands, 4-1
- DOS/VS job control and attention routine commands, 4-5
- DOS/VS Service Aids, 6-18
 - RJE I/O trace, 6-18
 - POWER/VS file dump program, 6-18
- DOS/VS system utilities, 6-1
- Dynamic Address Translation (DAT), 2-15

EDIT and EDMK pattern characters, 2-3

error restart procedures

 see restart procedures

extended mnemonic instructions, 2-3

fast copy disk volume utility, 6-2

fixed storage locations, 2-14

floating point instructions, 2-2

glossary, 7-1

hardstop option

 see CPU manual procedures

hexadecimal-decimal conversion, 2-15

hexadecimal table, 2-15

IBCDASDI utility, 6-14

IEBISAM utility, 6-15

IEBPTPCH utility, 6-16

IEHDASDR utility, 6-14

IEHLIST utility, 6-15

IEHMOVE utility, 6-16

IMPL procedure

 see CPU manual procedures

IPL DOS/VS commands, 4-1

IPL DOS/VS procedure, 4-161

IPL OS/VS procedure

 see CPU manual procedures

IPL VS1 example, 4-167

IPL VS2 JES2 example, 4-168

IPL VS2 JES3 example, 4-169

initialize data cell utility, 6-2

initialize disk utility, 6-2, 6-4

initialize tape utility, 6-2, 6-4

input/output

 command codes, 2-6

 devices list, 5-2

 restart procedures, see restart procedures

IBM

 1403 printer restart procedures, 5-42

 3270 display console operation, 5-54

 3340 disk drive operating hints, 5-32

 3410 tape operation, cleaning, handling, 5-37

 3420 tape operation, cleaning, handling, 5-40

 3504/3505 card reader restart procedures, 5-14

 3525 restart procedures, 5-20

 3525 error recovery, 5-28

IBM service call procedure, 1-11

interruption codes, 2-14

JES2 (OS/VS2) operator commands, 4-81
JES3 (OS/VS2) operator commands, 4-97

limited channel logout (hex B0), 2-14
loading a secondary nucleus
 see CPU manual procedures

machine check interruption code (hex E8), 2-14
machine instruction formats, 2-12
machine instructions, 2-1
magnetic tape, I/O command code, 2-6
magnetic tape, see also tape
manual controls S/370, function of, 3-1
message routing codes VS1, 4-59
message routing codes VS2, 4-59

OLTEP OS/VS1, 6-24

operands (definitions), 4-60

operator commands

 CMS, 4-149

 CP, 4-128

 CRJE system operator, 4-50

 display console control cmds OS/VS, 4-171

 display operating console (DOS/VS) cmds, 4-164

 DOS/VS IPL, 4-161

 DOS/VS job control and attention routine, 4-5

 POWER/VS, 4-20

 OS/VS1, 4-39

 OS/VS2 SVS, 4-62

 OS/VS2 system commands, 4-65

 OS/VS2 JES2, 4-81

 OS/VS2 JES3, 4-97

 RES workstation, 4-47

 TCAM, 4-51

 TSO, 4-109

 VM/370, 4-127

 VTAM network, 4-57

operating procedures

 see CPU manual procedures

operator trouble report 3270, 5-55

OS/VS1 checkpoint restart, 5-29

OS/VS1 operator commands, 4-39

OS/VS1 service aids, 6-20

OS/VS2 checkpoint restart, 5-30

OS/VS2 SVS, 4-62

OS/VS2 MVS system commands, 4-65

OS/VS2 JES2 commands, 4-81

OS/VS2 JES3 commands, 4-97

- page table entry, 2-15
- POWER/VS commands, 4-20
 - Central Operator Commands, 4-21
 - JECL, 4-28
 - RJE Terminal Commands, 4-33
- power-on procedure
 - see CPU manual procedure
- power-off procedure
 - see CPU manual procedures
- PRDMP Service Aid, 6-22
- printer
 - control characters, ANSI-defined, 2-11
 - 1403 restart procedures, 5-42
 - 3203 error recovery procedures, 5-44.
 - 3211 error recovery procedures, 5-47
- printlog utility, 6-3, 6-5
- problem determination chart, 1-1
- program function keys (PFK), 4-171
- program interruption codes, 2-13
- program status word (PSW)
 - BC mode, 2-13
 - EC mode, 2-13
 - alter PSW, see CPU manual procedures
 - display PSW, see CPU manual procedures
- punch
 - 3525 restart procedures, 5-20
 - 3525 error recovery routine, 5-28
- reader
 - general hints, 5-11
 - 3504/3505 restart procedures, 5-14
- RES workstation operator commands, 4-47
- restart procedures
 - 1403 printer, 5-42
 - 3203 printer, 5-44
 - 3211 printer, 5-47
 - 3505 card reader, 5-14
 - 3525 punch, 5-20
 - checkpoint restart OS/VS1, 5-29
 - checkpoint restart OS/VS2, 5-30
- routing codes VS1, 4-59
- routing codes VS2, 4-59
- SADMP Service Aid, 6-21
- secondary nucleus, loading of
 - see CPU manual procedures
- segment table entry, 2-15

- sense byte data, 5-3
 - 1017 paper tape reader, 5-3
 - 1018 paper tape punch, 5-3
 - 1287 optical reader, 5-3
 - 1288 optical page reader, 5-3
 - 1403 printer, 5-3
 - 1442 card read punch, 5-3
 - 1443 printer, 5-3
 - 1419 magnetic character reader, 5-3
 - 2260 display station, 5-3
 - 2301 drum storage, 5-3
 - 2305 fixed head storage, 5-3
 - 2314 disk storage, 5-3
 - 2319 disk storage, 5-3
 - 2321 data cell drive, 5-3
 - 2400 series tape units, 5-3
 - 2401 magnetic tape unit, 5-3
 - 2415 magnetic tape unit and control, 5-3
 - 2420 magnetic tape unit, 5-3
 - 2501 card reader, 5-3
 - 2520 card read punch, 5-3
 - 2540 card read punch, 5-3
 - 2560 multi-function card machine, 5-3
 - 2596 card read punch, 5-3
 - 2671 paper tape reader, 5-3
 - 2820 storage control (2301/2820), 5-3
 - 2822 paper tape reader control, 5-3
 - 3203 printer, 5-3
 - 3210 console printer keyboard, 5-3
 - 3211 printer, 5-3
 - 3215 console printer keyboard, 5-3
 - 3330 disk storage, 5-3
 - 3340 disk storage, 5-3
 - 3410/3411 magnetic tape unit and control, 5-3
 - 3420 magnetic tape unit, 5-3
 - 3504 card reader, 5-3
 - 3505 card reader, 5-3
 - 3525 card punch, 5-3
 - 3540 diskette, 5-3
 - 3800 printing subsystem, 5-2
 - 3803 tape control, 5-3
 - 3850 mass storage system, 5-2
 - 3881 optical mark reader, 5-3
 - 3886 optical character reader, 5-3
 - 5425 multi-function card unit, 5-3
- service aids, DOS/VS, 6-18
- service aids, OS/VS, 6-20
 - executing SADMP, 6-21
 - executing PRDMP, 6-22
- set parameter, day of year, 4-168
- status byte data, 5-1
 - see sense byte data for units

- stop on main storage address
 - see CPU manual procedures
- storage locations, fixed, 2-14
- store procedure
 - see CPU manual procedures (alter...)
- S/370 manual controls, 3-1

tape

- cleaning procedure 3410/3411, 5-37
- cleaning procedures 3420, 5-40
- handling and storage 3410/3411, 5-39
- operating procedures after failures
 - 3410/3411, 5-37
 - 3420, 5-40
- transport cleaning, 5-38
- TCAM operator commands, 4-51
- TSO operator commands, 4-109
- troubleshooting S/370, 1-11

utilities, DOS/VS, 6-1

- assign alternate track data cell, 6-1
- clear data cell, 6-1
- clear disk, 6-1
- copy and restore disk on data cell, 6-1
- copy and restore diskette, 6-2
- deblock, 6-2
- DITTO DOS/VS (FDP), 6-3, 6-6
- fast copy disk volume, 6-2
- control stream, 6-5
- fast copy Stand-Alone Version, 6-3
- initialize data cell, 6-2
 - control stream, 6-4
- initialize disk, 6-2
 - control stream, 6-4
- initialize tape, 6-2
 - control stream, 6-4
- printlog, 6-3
 - control stream, 6-5
- VTOC display, 6-3
 - control stream, 6-5

utilities, OS/VS

- data set utilities, 6-7
- executing a system utility, 6-12
 - card to print, 6-12
 - card to tape, 6-13
 - system list, 6-13
- functions they perform, 6-9
- independent utilities, 6-8
- system utilities, 6-7
- IBCDASDI, 6-8
 - control stream, 6-14
- IEBISAM, 6-7
 - control stream, 6-15
- IEBTPCH, 6-7
 - control stream, 6-16
- IEHDASDR, 6-7
 - control stream, 6-14
- IEHLIST, 6-7
 - control stream, 6-15
- IEHMOVE, 6-7
 - control stream, 6-16

video display control commands, 4-164, 4-171

video display operation, 5-54

video display screens

Mod 125, 5-49

Mod 158, 5-50

Mod 168, 5-51

virtual (logical) address format, 2-15

VM/370 commands, 4-127

VS1 operator commands, 4-39

VS2 Rel. 3 (JES2) operator commands, 4-81

VS2 Rel. 3 (JES3) operator commands, 4-97

VTAM network operator commands, 4-57

VTOC display utility, 6-3, 6-5

writing tape marks

3420 tape drive, 5-41

DOS/VS, see DOS DITTO, 6-21

OS/VS, use OS DITTO

.....
IBM SYSTEM/ 370 OPERATOR'S REFERENCE GUIDE, FORM SR20-4460-2

CIRCLE ONE OF THE COMMENTS AND EXPLAIN IN THE SPACE PROVIDED:

SUGGESTED ADDITION (PAGE____) SUGGESTED DELETION (PAGE____) ERROR (PAGE____)
EXPLANATION :

BUSINESS REPLY MAIL

NO POSTAGE STAMP NECESSARY IF MAILED IN THE UNITED STATES

POSTAGE WILL BE PAID BY:

IBM Education Center, Building 005
Department 78L, Publications Services
South Road
Poughkeepsie, New York 12602

FIRST CLASS
PERMIT NO. 40
ARMONK, NEW YORK

